



Servo Controllers

ESCON2

Firmware Specification



Table of Contents

1. About	1
1.1. About this document	1
1.1.1. Read this first	1
1.1.2. Intended purpose	1
1.1.3. Target audience	2
1.1.4. How to use	2
1.1.5. Symbols and signs	3
1.1.6. Trademarks and brand names	4
1.1.7. Sources for additional information	4
1.1.8. Copyright	4
1.2. About the devices	4
1.3. About the safety precautions	5
2. System overview	7
2.1. Device architecture	7
2.2. Device control	7
2.2.1. State of the drive	8
2.2.2. State transitions	9
2.2.3. Device control commands	9
2.2.4. Device LED Status	10
2.3. System units	10
2.3.1. Si units	11
2.3.2. CiA 402 Application profile-specific units	11
2.3.3. Unit prefixes	11
3. Operating modes	13
3.1. Operating mode selection guide	13
3.2. Overview	13
3.3. I/O Velocity Mode (IOVM)	13
3.3.1. How to use IOVM	14
3.3.2. Limits	15
3.4. I/O Current Mode (IOCM)	15
3.4.1. How to use IOCM	16
3.4.2. Limits	17
3.5. Velocity Control Function	17
3.5.1. How to use velocity control function	18
3.6. Current Control Function	18
3.6.1. How to use current control function	19
3.6.2. Output current limitation according to I ² T Method	20
4. Inputs and outputs	25
4.1. Digital inputs	25
4.1.1. Digital input timing behavior	25
4.2. Digital outputs	26
4.2.1. Digital output timing behavior	26
4.3. Analog inputs	26
4.3.1. Analog input timing behavior	27
4.4. Analog outputs	27

4.4.1. Analog output timing behavior	28
5. Communication	29
5.1. USB Communication	29
6. Object dictionary	31
6.1. Overview	31
6.1.1. Object data types	31
6.1.2. Object codes	31
6.1.3. Object access types	31
6.1.4. Object flags	31
6.1.5. Entries overview	32
6.2. Objects	34
6.2.1. Device type	34
6.2.2. Error register	34
6.2.3. Error history	35
6.2.4. Manufacturer device name	37
6.2.5. Store parameters	37
6.2.6. Restore default parameters	38
6.2.7. Identity object	39
6.2.8. Additional identity	40
6.2.9. Custom persistent memory	41
6.2.10. Power supply	42
6.2.11. Power supply supervision	42
6.2.12. Thermal protection	44
6.2.13. Axis configuration	45
6.2.14. Motor data	49
6.2.15. Electrical system parameters	51
6.2.16. Digital incremental encoder S2	52
6.2.17. Digital Hall sensor S1	53
6.2.18. Current control parameter set	54
6.2.19. Velocity control parameter set	55
6.2.20. Current demand value	57
6.2.21. Current actual values	57
6.2.22. Torque actual values	58
6.2.23. Velocity actual values	59
6.2.24. Target current	59
6.2.25. Current offset	60
6.2.26. Digital input properties	60
6.2.27. Configuration of digital inputs	61
6.2.28. Digital inputs functionality	65
6.2.29. Velocity set value switch parameter	65
6.2.30. Current set value switch parameter	67
6.2.31. Digital input PWM frequencies	69
6.2.32. Digital input PWM duty cycles	69
6.2.33. Digital outputs properties	70
6.2.34. Configuration of digital outputs	71
6.2.35. Digital outputs functionality	73
6.2.36. Analog input properties	74

6.2.37. Configuration of analog inputs	74
6.2.38. Analog input general purpose	76
6.2.39. Analog input adjustment	76
6.2.40. Analog input raw values	78
6.2.41. Analog output properties	79
6.2.42. Configuration of analog outputs	79
6.2.43. Analog output general purpose	80
6.2.44. Digital input PWM velocity set value scaling	81
6.2.45. Digital input PWM velocity set value offset scaling	84
6.2.46. Digital input PWM current set value scaling	86
6.2.47. Digital input PWM current set value offset scaling	88
6.2.48. Analog input velocity set value scaling	90
6.2.49. Analog input velocity set value offset scaling	93
6.2.50. Analog input current set value scaling	95
6.2.51. Analog input current set value offset scaling	98
6.2.52. Analog output velocity scaling	101
6.2.53. Analog output current scaling	103
6.2.54. Analog output temperature scaling	105
6.2.55. Thermal protection motor	109
6.2.56. Thermal protection power stage	109
6.2.57. Motor control	111
6.2.58. Error code	112
6.2.59. Controlword	112
6.2.60. Statusword	113
6.2.61. Modes of operation	114
6.2.62. Modes of operation display	115
6.2.63. Velocity demand value	115
6.2.64. Velocity actual value	115
6.2.65. Motor rated torque	116
6.2.66. Torque actual value	116
6.2.67. Max profile velocity	116
6.2.68. Max motor speed	117
6.2.69. Profile acceleration	117
6.2.70. Profile deceleration	117
6.2.71. Quick stop deceleration	118
6.2.72. SI unit velocity	118
6.2.73. SI unit acceleration	119
6.2.74. Velocity offset	119
6.2.75. Max acceleration	119
6.2.76. Additional velocity actual values	120
6.2.77. Digital inputs	121
6.2.78. Digital outputs	122
6.2.79. Target velocity	123
6.2.80. Motor type	123
6.2.81. Supported drive modes	123
7. Error Handling	125
7.1. Device errors	125

7.1.1. Generic error	126
7.1.2. Generic initialisation error	126
7.1.3. Overcurrent error	127
7.1.4. Power stage protection error	127
7.1.5. Power stage protection error	127
7.1.6. Overvoltage error	127
7.1.7. Undervoltage error	128
7.1.8. Thermal power stage overload error	128
7.1.9. Thermal power stage overload warning	128
7.1.10. Thermal logic section overload error	128
7.1.11. Hardware error	129
7.1.12. Hardware defect loading parameter error	129
7.1.13. Hardware configuration error	129
7.1.14. Hardware configuration error	129
7.1.15. Internal software error	129
7.1.16. Internal software error	130
7.1.17. Loading parameter failed error	130
7.1.18. Loading parameter failed error	130
7.1.19. Loading parameter failed error	130
7.1.20. Torque constant parameter error	130
7.1.21. Current offset adjustment warning	131
7.1.22. Main sensor breach error	131
7.1.23. Hall sensor signal error	131
7.1.24. Hall angle detection error	131
7.1.25. Missing main sensor error	132
7.1.26. Missing commutation sensor error	132
7.1.27. Main sensor direction error	132
7.1.28. Negative limit switch error	132
7.1.29. Positive limit switch error	132
7.1.30. Digital input 1 PWM frequency warning	133
7.1.31. Digital input 1 PWM duty cycle warning	133
7.1.32. Digital input 1 PWM error	133
7.1.33. Digital input 2 PWM frequency warning	133
7.1.34. Digital input 2 PWM duty cycle warning	133
7.1.35. Digital input 2 PWM error	134
7.1.36. System overloaded warning	134
7.1.37. Watchdog error	134
7.1.38. Watchdog error	134
7.1.39. System peak overloaded error	134
7.1.40. System peak overloaded error	135
7.1.41. Mode of operation not supported error	135
7.1.42. Regulation tuning identification error	135
7.1.43. Regulation tuning current error	135
7.1.44. Regulation tuning identification current error	135
7.1.45. Regulation tuning unrealistic result error	136
7.1.46. Regulation tuning identification error	136
7.1.47. Regulation tuning identification error	136

7.1.48. Regulation tuning identification error	136
7.1.49. Regulation tuning identification error	136
7.1.50. Regulation tuning standstill error	137
7.1.51. Regulation tuning torque constant error	137
7.1.52. Regulation tuning max system speed error	137
7.1.53. Regulation tuning motor connection error	137
7.1.54. Regulation tuning sensor signal error	137
7.2. Communication Errors (Abort Codes)	138
8. Firmware version history	139
8.1. Version overview	139

1. About

1.1. About this document

1.1.1. Read this first

These instructions are intended for qualified technical personnel. Prior commencing with any activities...

- *you must carefully read and understand this manual and*
- *you must follow the instructions given therein.*

The ESCON2 is considered as partly completed machinery according to EU Directive 2006/42/EC, Article 2, Clause (g) and are intended to be incorporated into or assembled with other machinery or other partly completed machinery or equipment.

Therefore, you must not put the device into service,...

- *unless you have made completely sure that the other machinery fully complies with the EU directive's requirements!*
- *unless the other machinery fulfills all relevant health and safety aspects!*
- *unless all respective interfaces have been established and fulfill the herein stated requirements!*

1.1.2. Intended purpose

The purpose of this document is to familiarize the user with the described equipment and the task of its safe and adequate installation and/or commissioning. Follow the described instructions in order to:

- avoid dangerous situations,
- keep installation and/or commissioning time at a minimum,
- increase the reliability and service life of the described equipment.

This document is part of a documentation set. It provides ESCON2 firmware details contains performance data and specifications, information on fulfilled standards, details on connections and pin assignment, and wiring examples. The below overview shows the documentation hierarchy and the interactions of its individual parts:

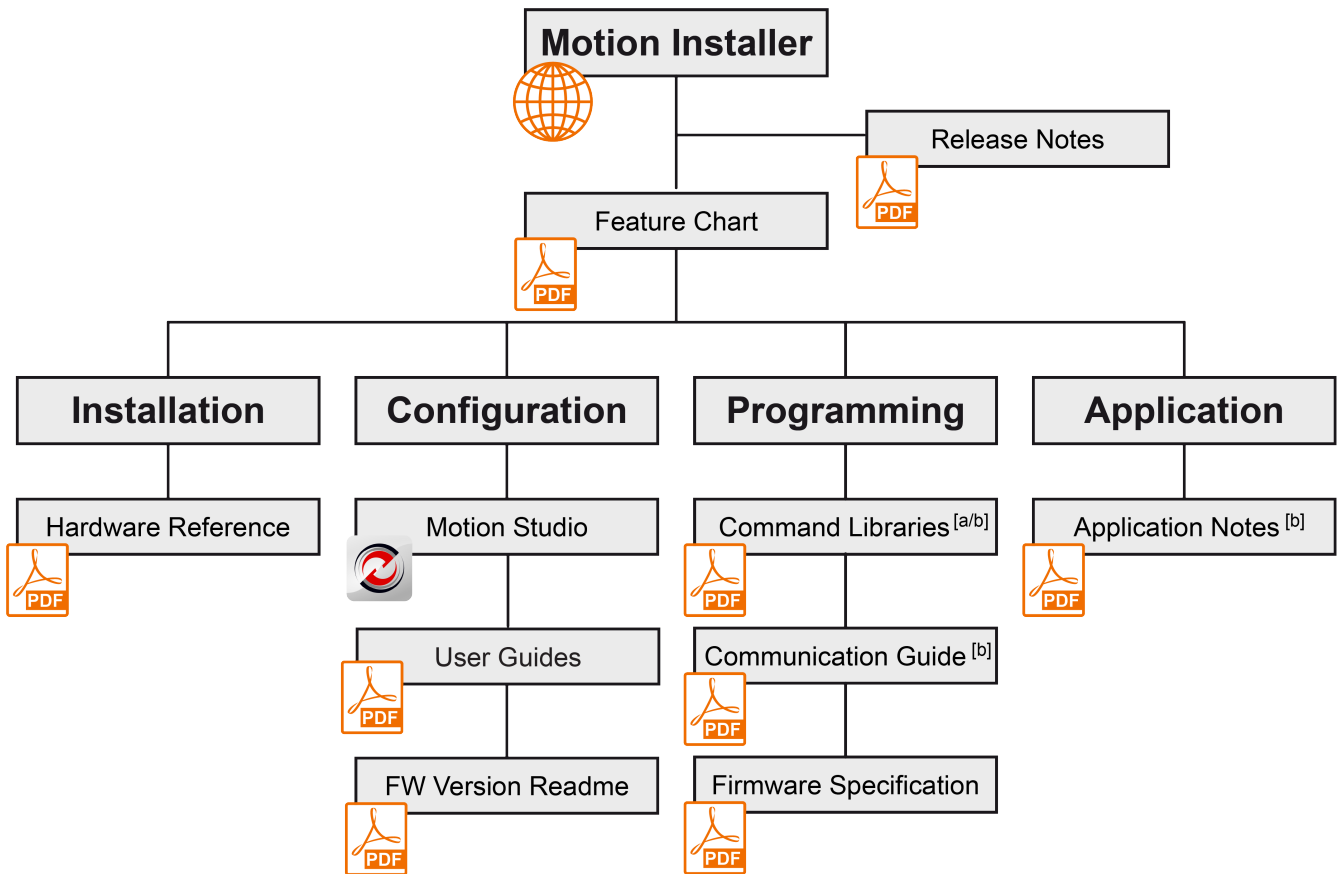

Figure 1. Documentation structure

^[a] including software programming examples

^[b] will be available with upcoming release

The latest edition of this document as well as additional documentation and software for ESCON2 controllers can also be found online: <http://escon.maxongroup.com>

1.1.3. Target audience

This document is a reference book. It requires knowledge and expertise specific to the equipment described.

1.1.4. How to use

Throughout the document, the following notations and codes will be used.

Notation	Explanation
ESCON2	stands for “ESCON2 servo controller”
«Abcd»	Indicating a title or a name (such as of document, product, mode, etc.)
(n)	Referring to an item (such as an order number, list item, etc.)
*	Referring to an internal value
→	Denotes “see”, “see also”, “take note of”, or “go to”

Table 1. Notations used

In later parts of this document, the following abbreviations and acronyms will be used:

Short	Description
CCW	Counterclockwise
CiA	CAN in Automation
CST	Cyclic Synchronous Torque Mode
CSV	Cyclic Synchronous Velocity Mode
CW	Clockwise
EDS	Electronic Data Sheet
GPIO	General Purpose Input/Output
NMT	Network Management
OBD	Object Dictionary
PDO	Process Data Object
PVM	Profile Velocity Mode
SDO	Service Data Object

Table 2. Abbreviations & acronyms used

1.1.5. Symbols and signs

In the course of the present document, the following symbols and signs will be used.









Type	Symbol	Meaning
Safety alert DANGER		Indicates an imminent hazardous situation . If not avoided, it will result in death or serious injury .
WARNING		Indicates a potential hazardous situation . If not avoided, it can result in death or serious injury .
CAUTION		Indicates a probable hazardous situation or calls the attention to unsafe practices. If not avoided, it may result in injury .
Prohibited action		Indicates a dangerous action. Hence, you must not!
Mandatory action		Indicates a mandatory action. Hence, you must!
Requirement, Note, Remark		Indicates an activity you must perform prior to continuing, or gives information on a particular point that must be observed.
Best practice		Indicates an advice or recommendation on the easiest and best way to further proceed.
Material Damage		Indicates information particular to possible damage of the equipment.

Table 3. Symbols and signs

1.1.6. Trademarks and brand names

For easier legibility, registered brand names are listed below and will not be further tagged with their respective trademark. It must be understood that the brands (the below list is not necessarily conclusive) are protected by copyright and/or other intellectual property rights, even if their legal trademarks are omitted in the latter parts of this document.

Brand name	Trademark owner
Adobe® Reader®	© Adobe Systems Incorporated, USA-San Jose, CA

Table 4. Brand names and trademark owners

1.1.7. Sources for additional information

For further details and additional information, please refer to the resources listed below:

Ref.no.	Title / description
[1]	USB Implementers Forum: Universal Serial Bus Revision 2.0 Specification www.usb.org/developers/docs
[2]	CiA 301 CANopen application layer and communication profile www.can-cia.org
[3]	CiA 305 Layer Setting Services (LSS) and protocols www.can-cia.org
[4]	CiA 306 CANopen electronic data sheet specification www.can-cia.org
[5]	CiA 402 CANopen device profile for drives and motion control www.can-cia.org
[6]	Bosch's CAN Specification 2.0 www.can-cia.org
[7]	Konrad Etschberger: Controller Area Network ISBN 3-446-21776-2
[8]	maxon: ESCON2 Communication Guide (will be available with upcoming release) http://escon.maxongroup.com
[9]	maxon: ESCON2 Application Notes http://escon.maxongroup.com
[10]	IEC 61158-x-12: Industrial communication networks – Fieldbus specifications (CPF 12)
[11]	IEC 61800-7: Adjustable speed electrical power drives systems (Profile type 1)
[14]	EN 5325-4 Industrial communications subsystem based on ISO 11898 (CAN) for controller device interfaces Part4: CANopen

Table 5. Sources for additional information

1.1.8. Copyright

© 2024 maxon. All rights reserved. Any use, in particular reproduction, editing, translation, and copying, without prior written approval is not permitted (contact: maxon international ltd., Brünigstrasse 220, CH-6072 Sachseln, +41 41 666 15 00, www.maxongroup.com). Infringements will be prosecuted under civil and criminal law. The mentioned trademarks belong to their respective owners and are protected under trademark laws. Subject to change without prior notice.

CCMC | ESCON2 Firmware Specification | Edition 2024-03 | DocID rel12245

1.2. About the devices

The ESCON2 is a small-sized, powerful 4-quadrant PWM servo controller. Its high power density allows flexible use for brushed DC motors and brushless EC (BLDC) motors up to approximately 1'800 Watts with various feedback options, such as Hall sensors, incremental encoders in a multitude of drive applications. The device is specially designed to be commanded and controlled by analog and digital set values.

It also features extensive analog and digital I/O functionality. Latest technology, such as field-oriented control (FOC), acceleration and velocity feed forward, in combination with highest control cycle rates allow sophisticated, ease-of-use motion control.

You might also want to look at the ESCON2 video library. It includes video tutorials that show you how to get started with «Motion Studio» and show you tips and techniques on how to set up communication interfaces, among other things.

1.3. About the safety precautions

- Make sure that you have read and understood chapter [Read this first](#).
- Do not engage with any work without possessing the stated skills (chapter [Target Audience](#)).
- Refer to chapter [Symbols and signs](#) to understand the subsequently used indicators!
- Any regulations applicable to the country and/or at the site of implementation with regard to health and safety/accident prevention, and/or environmental protection, must be observed.

Danger	
	<p>High voltage and/or electrical shock. Touching live wires causes death or serious injuries!</p> <ul style="list-style-type: none"> • Consider any power cable as connected to live power, unless having proven the opposite! • Make sure that neither end of cable is connected to live power! • Make sure that power source cannot be engaged while work is in process! • Obey lock-out/tag-out procedures! • Make sure to securely lock any power engaging equipment against unintentional engagement and tag it with your name!

Requirements	
	<ul style="list-style-type: none"> • Make sure that all associated devices and components are installed according to local regulations. • Be aware that, by principle, an electronic apparatus can not be considered fail-safe. Therefore, it must be ensured that any machine/apparatus has been fitted with independent monitoring and safety equipment. If the machine/apparatus should break down, if it is operated incorrectly, if the control unit breaks down or if the cables break or get disconnected, etc., the complete drive system must return – and be kept – in a safe operating mode. • Be aware that you are not entitled to perform any repair on components supplied by maxon.

Electrostatic sensitive device (ESD)	
	<ul style="list-style-type: none"> • Wear working cloth and use equipment in compliance with ESD protective measures. • Handle device with extra care. • Be aware that you are not entitled to perform any repair on components supplied by maxon.

2. System overview

2.1. Device architecture

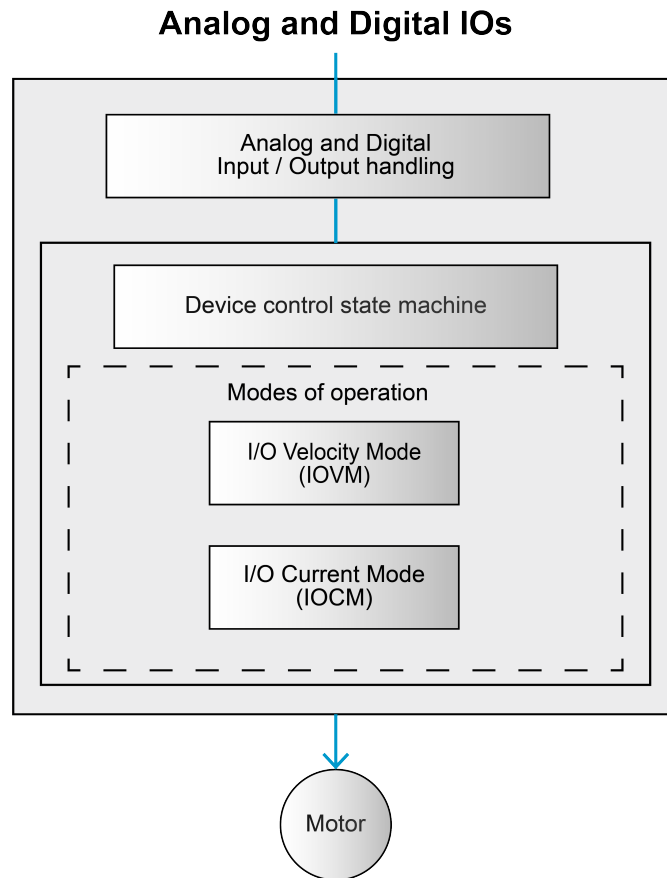

Figure 2. Communication architecture

DEVICE CONTROL

Starting and stopping of the drive and several mode-specific commands are executed by the state machine.

MODES OF OPERATION

The operating mode defines the behavior of the drive.

2.2. Device control

The state machine represents the device state as well as the device's potential control sequence. An object's state denotes a unique internal or external behavior. The commands that will be obeyed are also based on the device's status.

States may be changed using the [Controlword](#) and/or according to internal events. The actual state can be read using the [Statusword](#). A new state transition must not be initiated before the previous one is completed, and the [Statusword](#) is changed accordingly.

Using the [Controlword](#) and/or in response to internal events, states can be modified. The [Statusword](#) can be used to read the current condition. Before the previous state transition is finished and the [Statusword](#) is updated appropriately, a new one cannot be started.

2.2.2. State transitions

State transitions are caused by internal events in the drive or by commands from the host via the [Controlword](#).

Note:	
	<i>If a command is received that causes a change of state, this command will be processed completely and the new state attained before the next command can be processed.</i>

Transition	Event	Action
0	Reset	Initialize drive
1	Drive has initialized successfully	Activate communication
2	«Shutdown» command received	-
3	«Switched on» command received	Initialize current sensor. Current offset calibration. Motor must stand still to allow a precise calibration.
4	«Enable operation» command received	Enable the driving function, including the current controller and any superordinate controllers that may be required.
5	«Disable operation» command received	Stop movement according to «Disable operation option code». Disable drive function.
6	«Shutdown» command received	Disable power section
7	«Quick stop» or «Disable voltage» command received	-
8	«Shutdown» command received	Stop movement according to «Shutdown option code». Disable drive function and power section.
9	«Disable voltage» command received	Stop movement according to «Shutdown option code». Disable drive function and power section.
10	«Quick stop» or «Disable voltage» command received	-
11	«Quick stop» command received	Stop movement according to «Quick stop option code»
12	«Disable voltage» command received	Disable drive function and power section
13	A fault has occurred	Start fault reaction
14	The fault reaction is completed	Disable drive function and power section
15	«Fault reset» command received	Reset fault condition if no fault is present
16	«Enable operation» command received	-

Table 7. Device state transitions

2.2.3. Device control commands

Axis control commands are triggered by the following bit patterns in the [Controlword](#).

Note:	
	<i>If a command is received that causes a change of state, this command will be processed completely and the new state attained before the next command can be processed.</i>

Command	Controlword LowByte [binary]	State transition
Shutdown	0xxx x110	2, 6, 8
Switch on	0xxx x111	3
Switch on & Enable operation	0xxx 1111	3, 4 ^(*)
Disable voltage	0xxx xx0x	7, 9, 10, 12
Quick stop	0xxx x01x	11
Disable operation	0xxx 0111	5
Enable operation	0xxx 1111	4, 16
Fault reset	0xxx xxxx → 1xxx xxxx	14, 15
Clear warning	0xxx xxxx → 1xxx xxxx	N/A ^(*)

Table 8. Axis control commands

^(*) Automatic transition to state «Operation enabled» after execution of command «Switch on»

^(*) Warning can be cleared in any state and does not lead to state transition

2.2.4. Device LED Status

The device provides a red and a green LED to display the actual operation state and possible errors of the device:

- LED green shows the operation state
- LED red indicates errors

LED Green	LED Red	Warning / Error	Description
Slow	OFF	No warning/error active.	Power stage is disabled. The ESCON2 is in status - Switch on disabled
Slow	Slow	At least one warning is active.	- Ready to switch on - Switched on
ON	OFF	No warning/error active.	Power stage is enabled. The ESCON2 is in status
ON	Slow	At least one warning is active.	- Operation enabled - Quick stop active
ON	ON	At least one error has occurred.	Power stage is enabled. The ESCON2 is in status - Fault reaction active
OFF	ON	At least one error has occurred.	Power stage is disabled. The ESCON2 is in status - Fault
Flash	ON	n/a	Firmware update in progress or invalid application ^(*)

Flash = LED is flashing (0.9s OFF, 0.1s ON)
Slow = LED is slowly blinking (0.5s OFF, 0.5s ON)
ON = LED is on
OFF = LED is off

^(*) Normally, this LED status is visible for a few seconds only, during a firmware download. If this state is active for a longer time or even after a power cycle, it means that no valid application is loaded. → Firmware download is needed.

Table 9. LED system state indicator

2.3. System units

The user-defined units for this device are as follows:

- Velocity units ([SI unit velocity](#))
- Acceleration units ([SI unit acceleration](#))

The units are used for all objects that support user-defined units. They are specified by SI unit objects. Objects with factor group-independent values have fixed units specified by the object. The coding of user-defined units and prefixes is structured as described in [User-defined units - Parameter structure](#).

Bit 31...24	Bit 24...16	Bit 15...8	Bit 7...0
Prefix	Numerator	Denominator	Reserved(0)

Table 10. User-defined units - Parameter structure

2.3.1. SI units

Description	Name	Symbol	Notation index
Dimensionless	-	-	0x00
Length	Meter	m	0x01
Mass	Kilogram	kg	0x02
Time	Second	s	0x03
Electric current	Ampere	A	0x04
Time	Minute	min	0x47
Square second	Square second	s ²	0x57

Table 11. SI units - Notation index

2.3.2. CiA 402 Application profile-specific units

Description	Name	Symbol	Notation Index
Revolutions	revolutions	rev	0xB4
Increments	increments	inc	0xB5
Steps	steps	steps	0xAC
Velocity (manufacturer-specific)	revolutions/minute	rpm	0xC0

Table 12. CiA 402 Application profile-specific units - Notation index

2.3.3. Unit prefixes

Prefix	Factor	Symbol	Notation index
Mega	10 ⁶	M	0x06
Kilo	10 ³	k	0x03
Hecta	10 ²	h	0x02
Deca	10 ¹	da	0x01
-	10 ⁰	-	0x00
Deci	10 ⁻¹	d	0xFF
Centi	10 ⁻²	c	0xFE
Milli	10 ⁻³	m	0xFD
—	10 ⁻⁴	—	0xFC
—	10 ⁻⁵	—	0xFB

Prefix	Factor	Symbol	Notation index
Micro	10^{-6}	μ	0xFA

Table 13. Unit prefixes - Notation index

3. Operating modes

3.1. Operating mode selection guide

The device behavior depends on the currently activated mode of operation.

- Choose desired mode [Overview](#)
- Select mode using [Modes of operation](#)
- Read currently active mode from [Modes of operation display](#)

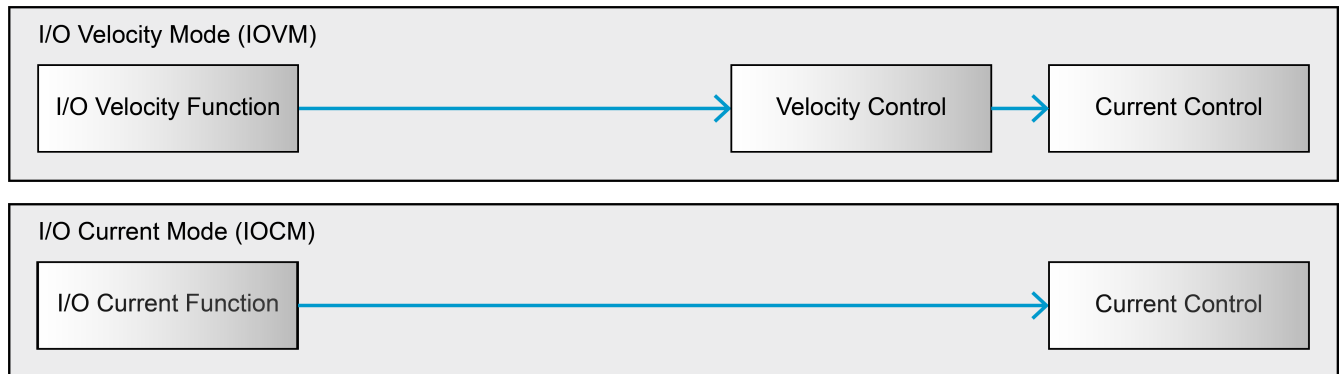

Figure 4. Functional architecture

3.2. Overview

I/O Velocity Mode (IOVM)

An analog input provides a target velocity to the drive device, which then performs velocity control and torque control. For details see [I/O Velocity Mode \(IOVM\)](#)

I/O Current Mode (IOCM)

An analog input provides a target current to the drive device. For details see [I/O Current Mode \(IOCM\)](#)

3.3. I/O Velocity Mode (IOVM)

The «I/O Velocity Mode» is used for velocity control in correspondence with I/O commanding. The configured input provides a set value velocity to the drive, which then performs velocity control with underlying current control. See [Configuration of digital inputs](#) and [Configuration of analog inputs](#) for further information.

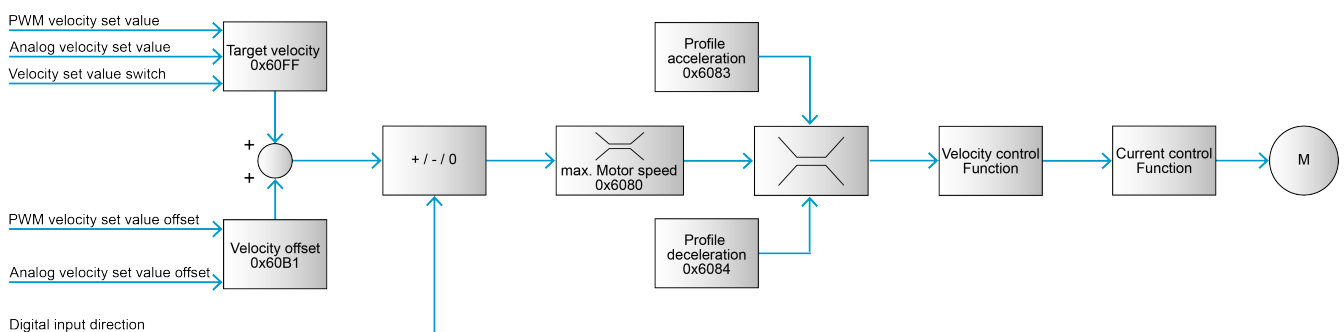

Figure 5. I/O Velocity Mode - overview

The I/O Velocity Mode is based on [Velocity Control Function](#). [Target velocity](#) is used as the set value while [Motor data](#) and [Max motor speed](#) are used to determine current and velocity limitations. Furthermore, [Profile acceleration](#) and [Profile deceleration](#) are used to limit the rate of change for the speed controller input.

3.3.1. How to use IOVM

3.3.1.1. Configuration parameters

Parameter	Index	Description
Nominal current	0x3001-0x01	The maximum permissible continuous current of the motor
Current control parameter set	0x30A0	Configuration of the current controller gains
Velocity control parameter set	0x30A2	Configuration of the velocity controller
Motor rated torque	0x6076	Holds the value to which all torque objects are related to
Max motor speed	0x6080	Indicates the configured maximum allowed speed for the motor. It serves as protection of the motor and is taken from the motor data sheet.
Quick stop deceleration	0x6085	Defines the deceleration for the quick stop ramp (for stopping only)
Max acceleration	0x60C5	Defines the maximum allowed acceleration and deceleration

Table 14. I/O Velocity Mode - Configuration parameters

3.3.1.2. Commanding parameters

Parameter	Index	Description
Target velocity	0x60FF	Velocity input value for the velocity controller
Velocity offset	0x60B1	Optional velocity feed forward input
Profile acceleration	0x6083	Defines the acceleration ramp during a movement
Profile deceleration	0x6084	Defines the deceleration ramp during a movement

Table 15. I/O Velocity Mode - Commanding parameters

3.3.1.3. Controlword

I/O velocity mode does not use mode-specific controlword bits.

3.3.1.4. Output parameters

Parameter	Index	Description
Velocity actual value	0x606C	Actual velocity value
Current actual value	0x30D1-0x02	Actual current value

Table 16. I/O Velocity Mode - Output parameters

3.3.1.5. Statusword (I/O Velocity Mode - Specific Bits)

Bit 15, 14	Bit 13	Bit 12	Bit 11	Bit 10	Bit 9...0
Statusword bits	Reserved	drive follows command value	Limits	Reserved	Statusword bits

Table 17. I/O Velocity Mode - Statusword

Name	Value	Description
drive follows command value	0	Drive does not follow the target value
	1	Drive is in state operation enables and follows the target and set values of the control device

Table 18. I/O Velocity Mode - Statusword bits

3.3.2. Limits

Depending on the configuration, the velocity commanded may not be reached due to limits. When this occurs, bit 11 of the [Statusword](#) will be set. This state can also be mapped to an output pin through a [Digital outputs functionality](#).

Limitation	Description	Effect
Output current limit	The velocity set value cannot be reached because the required current would exceed the current allowed by the object Output current limit	The Current demand value will be limited to Output current limit .
Thermal protection motor	The velocity set value cannot be reached because an internal I2T model estimating the motor temperature is limiting the Current demand value , in order to prevent the motor from overheating.	The model limits the Current demand value to a maximum of between Nominal current and Output current limit . Related Objects: Nominal current , Thermal time constant winding , I2t level motor .
Thermal protection power stage	The velocity set value cannot be reached because the power stage temperature (measured and/or I2T model) is limiting the Current demand value , in order to prevent the power stage from overheating.	The Current demand value is limited, in the worst case to 0. Related Objects: I2t level power stage , Temperature power stage , Max temperature power stage .
Max motor speed	The velocity set value cannot be reached because it is larger than Max motor speed .	The Velocity demand value is limited to a maximum value of Max motor speed .
PWM max duty cycle	The velocity set value cannot be reached because the PWM duty cycle actual value has reached the PWM max duty cycle , indicating that the required voltage cannot be reached. This may be due to the Power supply voltage being too low.	The Current actual value will be lower than the Current demand value .

Table 19. I/O Velocity Mode - Limits

3.4. I/O Current Mode (IOCM)

The «I/O Current Mode» is used for current control in correspondence with I/O commanding. The configured input provides a current set value to the drive, which then performs current control. See [Configuration of digital inputs](#) and [Configuration of analog inputs](#) for further information.

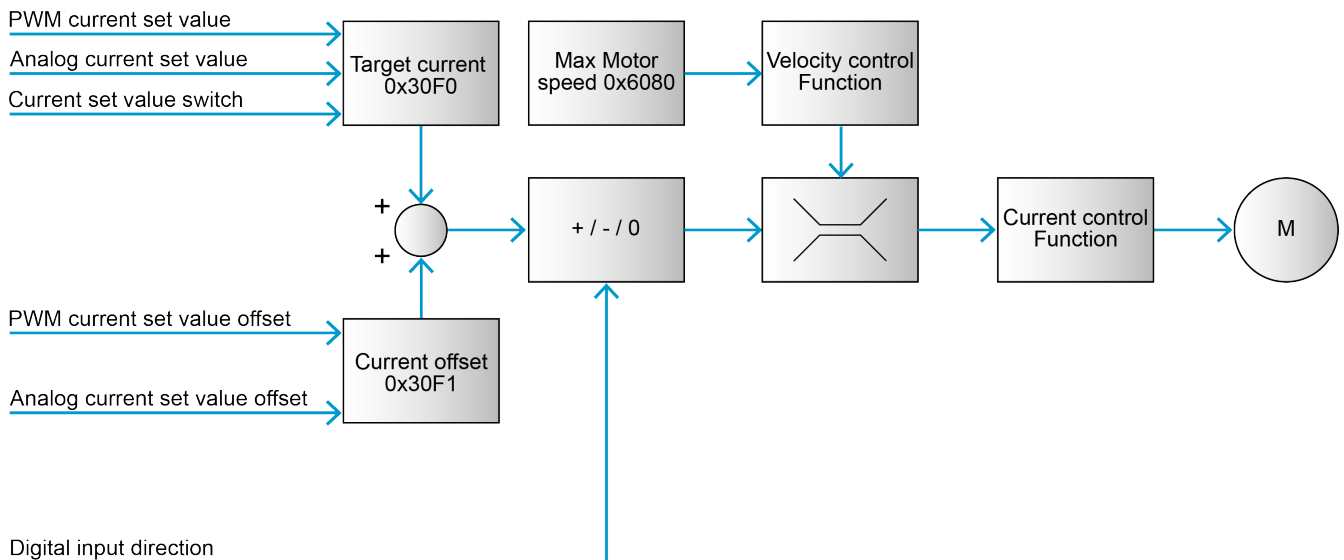

Figure 6. I/O Current Mode - Overview

I/O Current Mode is based on the current control function. Inputs are [Target current](#) and [Current offset](#). The [Motor data](#) is used to define limitations for velocity and current values.

Note:



Speed limitation is only active if the main sensor is configured in [Control structure](#). In this case, the [Velocity control parameter set](#) must be configured/tuned.

3.4.1. How to use IOCM

3.4.1.1. Configuration parameters

Parameter	Index	Description
Nominal current	0x3001-0x01	The maximum permissible continuous current of the motor
Current control parameter set	0x30A0	Configuration of the current controller gains
Velocity control parameter set	0x30A2	Configuration of the velocity controller gains. This is necessary in order to optimally limit the velocity to max motor speed
Max motor speed	0x6080	Indicates the configured maximum allowed speed for the motor. It serves as protection of the motor and is taken from the motor data sheet.
Quick stop deceleration	0x6085	Defines the deceleration for the quick stop ramp (for stopping only)

Table 20. I/O Current Mode - Configuration parameters

3.4.1.2. Commanding parameters

Parameter	Index	Description
Target current	0x30F0	Current input value for the current controller
Current offset	0x30F1	Optional additive current which is added to the target current value

Table 21. I/O Current Mode - Commanding parameters

3.4.1.3. Controlword

I/O current mode does not use mode-specific controlword bits.

3.4.1.4. Output parameters

Parameter	Index	Description
Current actual values	0x30D1	Current actual values
Velocity actual value	0x606C	Actual velocity value

Table 22. I/O Current Mode - Output parameters

3.4.1.5. Statusword (I/O current mode - Specific bits)

Bit 15, 14	Bit 13	Bit 12	Bit 11	Bit 10	Bit 9...0
Statusword bits	Reserved	drive follows command value	Limits	Reserved	Statusword bits

Table 23. I/O Current Mode - Statusword

Name	Value	Description
drive follows command value	0	Drive does not follow the target value
	1	Drive is in state operation enables and follows the target and set values of the control device

Table 24. I/O Current Mode - Statusword bits

3.4.2. Limits

Depending on the configuration, the current commanded may not be reached due to limits. When this occurs, bit 11 of the [Statusword](#) will be set. This state can also be mapped to an output pin through a [Digital outputs functionality](#).

Limitation	Description	Effect
Output current limit	The current set value cannot be reached because it exceeds the current allowed by the object Output current limit	The Current demand value will be limited to Output current limit .
Thermal protection motor	The current set value cannot be reached because an internal I2T model estimating the motor temperature is limiting the Current demand value , in order to prevent the motor from overheating.	The model limits the Current demand value to a maximum of between Nominal current and Output current limit . Related Objects: Nominal current , Thermal time constant winding , I2t level motor .
Thermal protection power stage	The current set value cannot be reached because the power stage temperature (measured and/or I2T model) is limiting the Current demand value , in order to prevent the power stage from overheating.	The Current demand value is limited, in the worst case to 0. Related Objects: I2t level power stage , Temperature power stage , Max temperature power stage .
Max motor speed	The current set value cannot be reached because it would result in the motor turning faster than Max motor speed .	The Current demand value is limited by the Velocity Control Function to prevent the motor turning faster than Max motor speed until the speed or current set value decrease.
PWM max duty cycle	The current set value cannot be reached because the PWM duty cycle actual value has reached the PWM max duty cycle , indicating that the required voltage cannot be reached. This may be due to the Power supply voltage being too low.	The Current actual value will be lower than the Current demand value .

Table 25. I/O Current Mode - Limits

3.5. Velocity Control Function

Used for velocity-based modes, and velocity limitation in current-based modes, where applicable.

The control loop is fed with the velocity demand value and velocity actual value as input parameters. The behavior of the control may be influenced by externally applicable control parameters. The output of the controller is a current demand value, which serves as input for the current controller.

Note:



Items marked with an asterisk (*) refer to internal values.

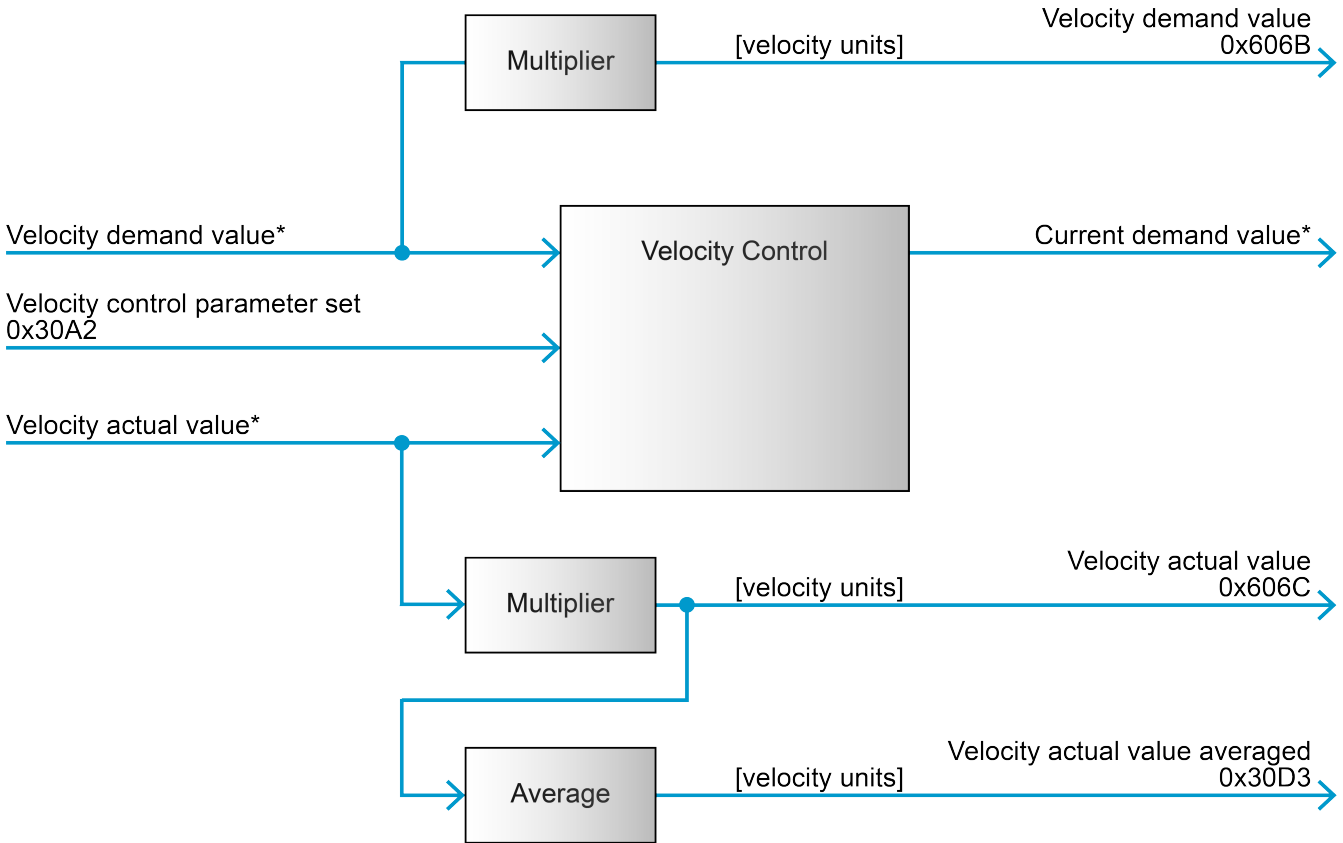

Figure 7. Velocity Control Function - Block diagram

3.5.1. How to use velocity control function

3.5.1.1. Configuration parameters

Parameter	Index	Description
Velocity control parameter set	0x30A2	Configuration of the velocity controller gains

Table 26. Velocity Control Function - Configuration parameters

3.5.1.2. Commanding parameters

There are no commanding parameters. The velocity control function is directly commanded by velocity-based operating modes.

3.5.1.3. Output parameters

Parameter	Index	Description
Velocity demand value	0x306B	The operation mode's output. It is used as input for the velocity control function. Generally, the value is the output of the trajectory generator.
Velocity actual value	0x606C	The actual velocity value
Velocity actual values	0x30D3	The averaged actual velocity value

Table 27. Velocity Control Function - Output parameters

3.6. Current Control Function

All operating modes are based on the current control function. The **Current demand value** is received from a superordinate motion controller.

Note:



Items marked with an asterisk (*) refer to internal values.

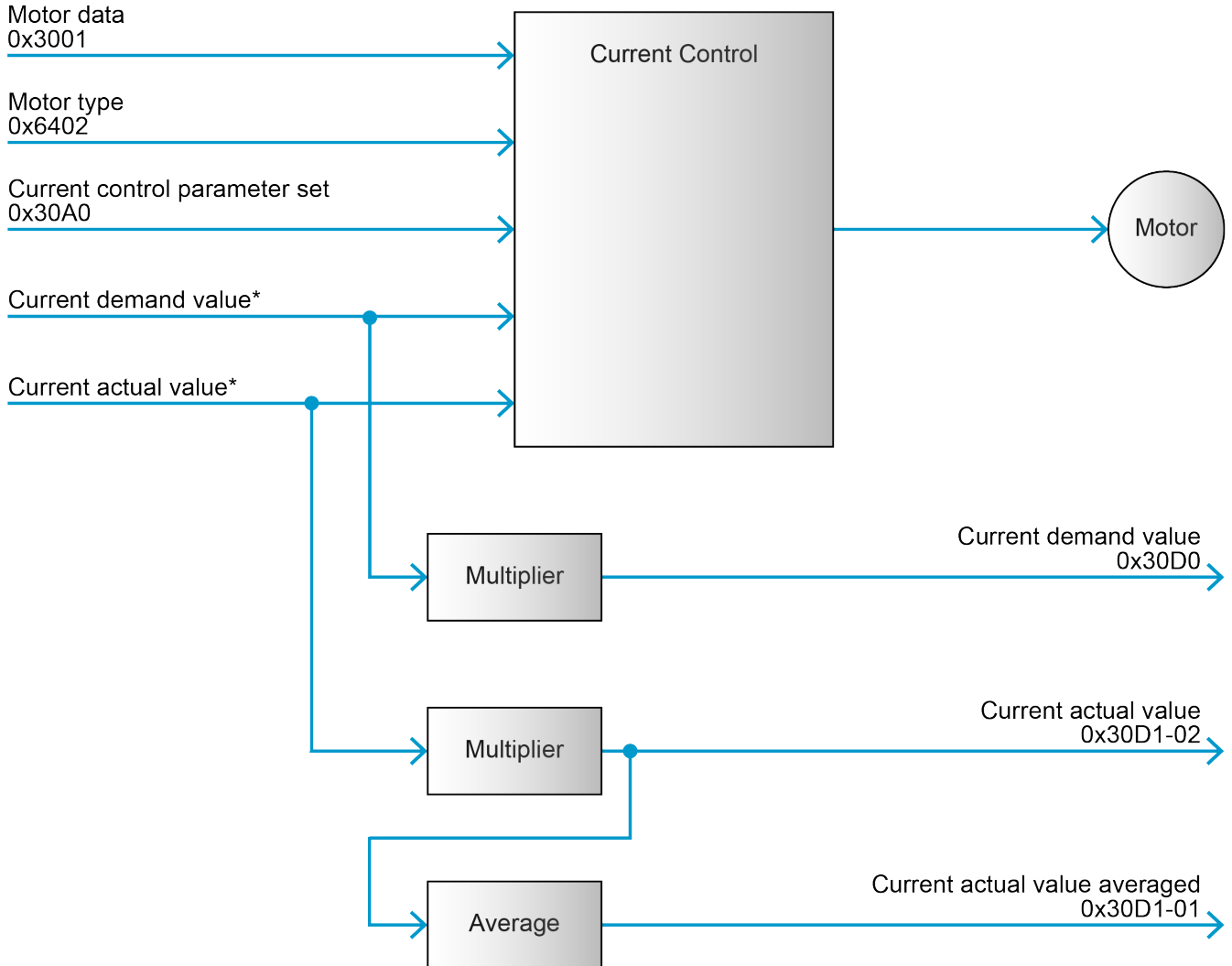

Figure 8. Current Control Function - Block diagram

3.6.1. How to use current control function

3.6.1.1. Configuration parameters

Parameter	Index	Description
Motor data	0x3001	Used for configuration of motor-dependent parameters
Current control parameter set	0x30A0	Configuration of the current controller gains
Motor type	0x6402	Used to define the type of motor

Table 28. Current Control Function - Configuration parameters

3.6.1.2. Commanding parameters

There are no commanding parameters. The current control function is commanded by the control loop [Velocity Control Function](#) or directly by the operating mode [I/O Current Mode \(IOCM\)](#).

3.6.1.3. Output parameters

Parameter	Index	Description
Current demand value	0x30D0	Set value for current controller
Current actual values	0x30D1	The averaged and actual current value

Table 29. Current Control Function - Output parameters

3.6.2. Output current limitation according to I²T Method

The I²T method is to prevent the motor from overheating. This method is based on the model of the motor's thermal dynamics which serves as the foundation for this technique. Its parameters are **Nominal current** and **Thermal time constant winding**. When the motor's I²T level approaches 100%, the procedure reduces the output current to the nominal current. This limit is deactivated when the I²T level of the motor falls below 90% again. Keep in mind that the **Nominal current** is specified under particular heat dissipation conditions and at a set ambient temperature (often 25 °C). The aforementioned settings need to be changed if these requirements are not met.

Rather than providing the thermal time constant of the winding τ_{th} , the motor manufacturer may provide the peak current I_{peak} and the peak current duration T_{peak} . In this case, the thermal time constant winding τ_{th} can be calculated using the following equation:

$$\tau_{th} = - \frac{T_{peak}}{\ln \left(1 - \left(\frac{I_N^2}{I_{peak}^2} \right) \right)}$$

where

\ln : natural logarithm function

τ_{th} : thermal time constant winding

T_{peak} : Time during which peak current is permitted

I_{peak} : Peak current

I_N : Nominal current

The figure below shows the maximum duration of the peak current before the I²T current limit is activated, assuming that the I²T level motor starts at 0%. The peak current duration is normalized by the thermal time constant winding on the horizontal axis (x-axis). The vertical axis (y-axis) represents the magnitude of the peak current normalized by the nominal current.

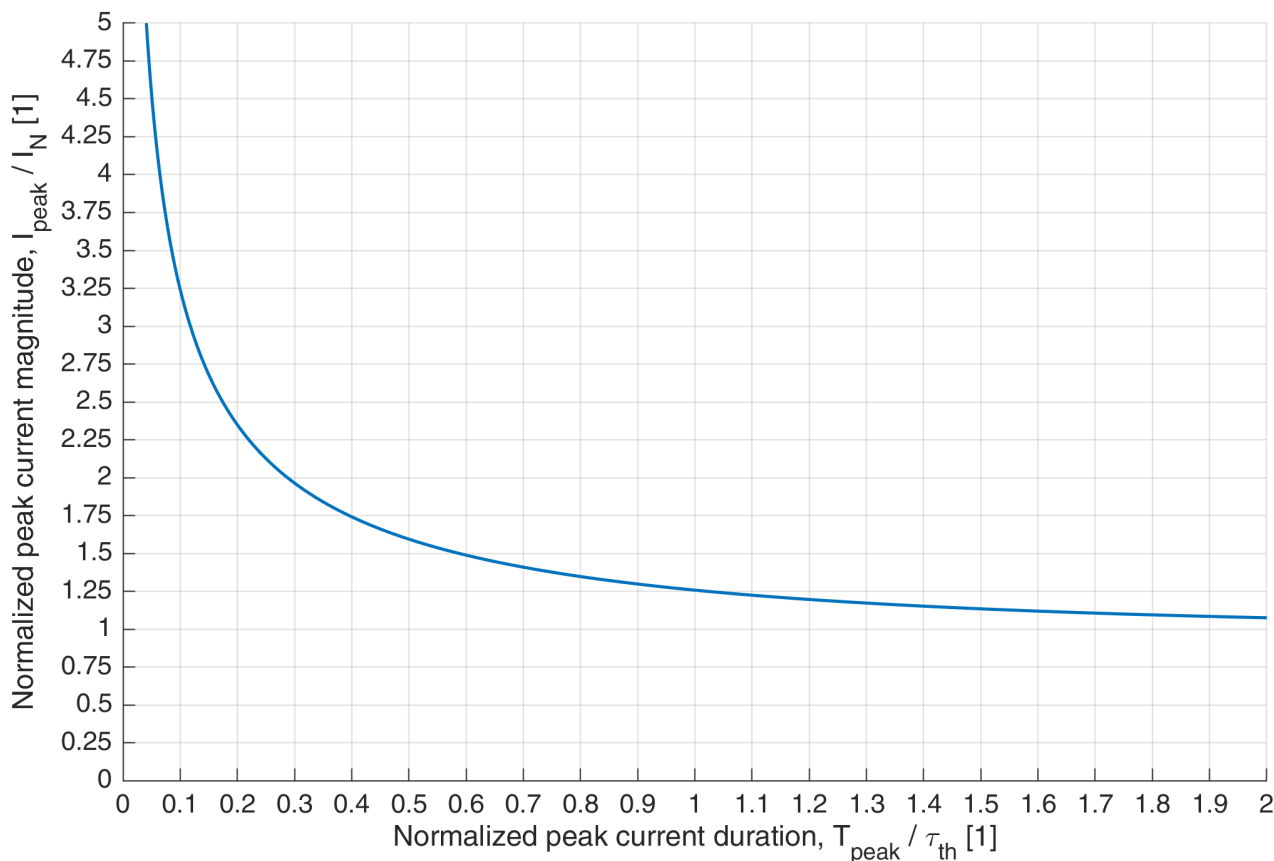

Figure 9. Normalized peak current magnitude vs. Normalized peak current duration

EXAMPLE: How long can we accelerate the motor with a steady current of 2940 mA with the following Motor data configuration?

- Current limit: 1470 mA
- Thermal time constant winding τ_{th} : 2.8s

To summarize and clarify the process you've described for calculating the peak current duration for a motor acceleration, follow these steps:

1. Calculate the Normalized Peak Current Magnitude:
 - Use the formula: Normalized Peak Current = Actual Peak Current / Rated Peak Current
 - In our example, this is 2940 mA / 1470 mA = 2
2. Find the Intersection on the figure [Normalized peak current magnitude vs. Normalized peak current duration](#):
 - Use the graph of 'Normalized Peak Current Magnitude vs. Normalized Peak Current Duration'.
 - Find the point where the normalized peak current magnitude (from step 1) intersects with the curve on the graph.
 - In your example, the intersection for a normalized peak current of 2 on the blue curve corresponds to an x-axis value of approximately 0.3.
3. Calculate the Peak Current Duration (T_{peak}):
 - Use the formula: $T_{\text{peak}} = \text{Normalized Peak Current Duration (from graph)} \times \text{Thermal Time Constant Winding}$
 - In this example, $T_{\text{peak}} = 0.3 \times 2.8 \text{ s} = 840 \text{ ms}$

Therefore, for a motor with these specific parameters (2940 mA peak current and 2.8 s thermal time constant winding), it can sustain the acceleration with a constant current of 2940 mA for 840 milliseconds.

The cyclic ON-OFF mode described is a common way to control motors, particularly in applications where varying the motor speed or reducing the heat generated by the motor is important. Let's break down the key components of this mode:

1. ON Time Current Magnitude (I_{on}):

- This is the current magnitude when the motor is in the ON state.
- I_{on} can be higher than the motor's nominal current (I_N), allowing for greater torque or speed during the ON phase.

2. ON Time (T_{on}):

- The duration for which the motor current is ON and the motor is actively powered.

3. OFF Time (T_{off}):

- The duration for which the motor current is OFF and the motor is not powered.
- During this time, no current flows through the motor.

4. Total Time (T_{total}):

- The sum of the ON time and OFF time ($T_{total} = T_{on} + T_{off}$).
- This is the complete cycle duration of one ON-OFF sequence.

5. Duty Cycle:

- The ratio of ON time to the total time, usually expressed as a percentage.
- Formula: Duty Cycle = $(T_{total}/T_{on}) \times 100\%$.
- It indicates the proportion of one cycle in which the motor is active.

Understanding and controlling these parameters is crucial for efficient motor operation, especially in applications requiring precise control over motor speed, torque, or thermal management. The duty cycle, in particular, is a key parameter as it directly influences the motor's average power output and heat generation over time. Higher duty cycles mean the motor is ON for a greater proportion of the cycle, leading to increased average power output and potentially more heat generation. Conversely, a lower duty cycle reduces average power output and can help manage heat generation in the motor.

The cyclic ON-OFF mode is a very simplified model of the current profile for the case that the current to hold a constant velocity is negligible compared to the current required for acceleration and deceleration.

The following figure [Cyclic mode standardized vs. standardized "ON time"](#) shows the maximum I_{on} for continuous operation without reaching the I²T current limit, with a given motor current duty cycle and T_{total} .

1. Motor Current Duty Cycle:

- Represented on the horizontal axis.
- Defined as Duty Cycle = T_{total}/T_{on}
- This ratio represents the proportion of time the motor current is ON (T_{on}) in relation to the total cycle time (T_{total}).

2. 'ON Time' Current Magnitude (I_{on}) Normalized:

- Shown on the vertical axis.
- It is the ON time current magnitude (I_{on}), normalized with the motor's nominal current (I_N). Essentially, this shows how much larger the ON current can be compared to the motor's typical operating current.

3. Total Time (T_{total}) and Thermal Time Constant Winding (T_{th}):

- Each curve on the graph represents a different ratio of the total time (T_{total}) to the thermal time constant winding (τ_{th}).
- The thermal time constant winding is a measure of how quickly the motor heats up and cools down. Different ratios of T_{total} to τ_{th} will affect how much current the motor can handle during the ON phase without overheating.

4. Interpreting the Graph:

- The graph is used to determine the maximum permissible I_{on} for continuous operation without exceeding the I_2T limit for a given duty cycle and total time.
- For a specified duty cycle (T_{on}/T_{total}), the graph shows the maximum I_{on} (as a multiple of I_N) that can be applied without causing thermal damage to the motor.
- Different curves are useful for motors with different thermal properties (as indicated by τ_{th}).

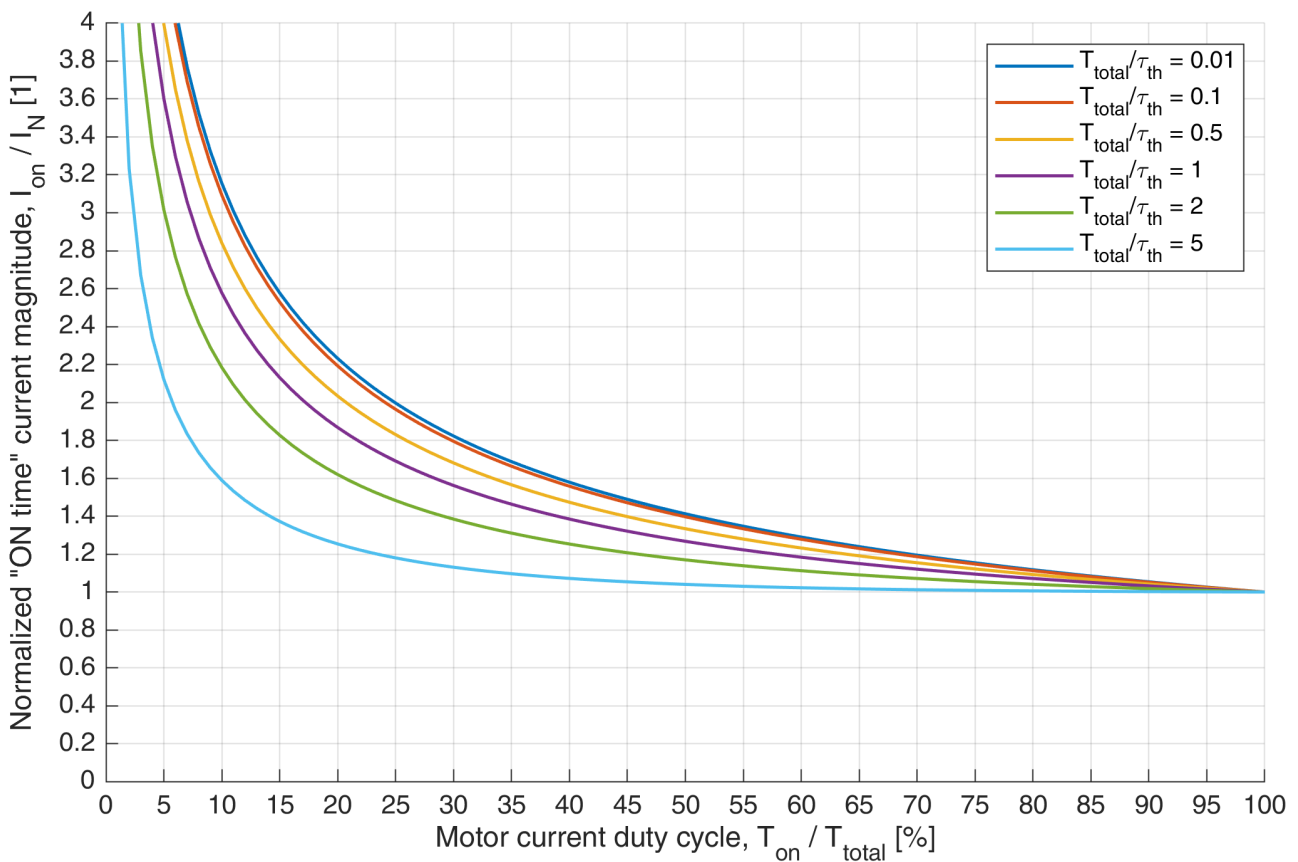

Figure 10. Cyclic mode standardized vs. standardized "ON time"

To summarize and calculate the maximum "ON time" current magnitude (for details see [Motor data](#)) (I_{on}) for the given configuration based on the cyclic ON-OFF mode, follow these steps:

1. Identify the Relevant Curve on the Graph:

- Since the period of the current (T_{total}) is the same as the thermal time constant winding (τ_{th}), which is 2.8s in this case, you should use the purple curve in the figure [Cyclic mode standardized vs. standardized "ON time"](#).

2. Find the Intersection on the Graph:

- Locate the point where the motor current duty cycle of 10% intersects with the purple curve on the graph.

3. Read the Normalized 'ON Time' Current Magnitude (I_{on}) Value:

- From the intersection point, read the y-axis value, which represents the normalized 'ON time' current

magnitude. In this example, it's approximately 2.6.

4. Calculate the Maximum 'ON Time' Current Magnitude (I_{on}):

- Since the y-axis is normalized with the nominal current (I_N), the actual I_{on} can be calculated by multiplying the normalized value by the nominal current.
- Formula: $I_{on} = \text{Normalized } I_{on} \times \text{Nominal Current}$
- In this example: $I_{on} = 2.6 \times 1470 \text{ mA} = 3822 \text{ mA}$.

Therefore, for this specific motor configuration operating in an ON-OFF cyclic mode with a duty cycle of 10%, the maximum 'ON time' current magnitude that can be applied without exceeding the motor's thermal limits is approximately 3822 mA.

4. Inputs and outputs

For further information on voltage levels, resolutions, bandwidth and switching delays, consult the related controller's hardware reference manual (see [Documentation structure](#)).

4.1. Digital inputs

For process control, there are predefined functions and general-purpose inputs available.

The digital input function configuration is done with [Configuration of digital inputs](#), the polarity is set with [Digital input properties](#).

The functionality state is read using [Digital inputs functionality](#) (all functionalities) and [Digital inputs](#) (CiA-specified functionalities), while the input logic state is read with [Digital input properties](#).

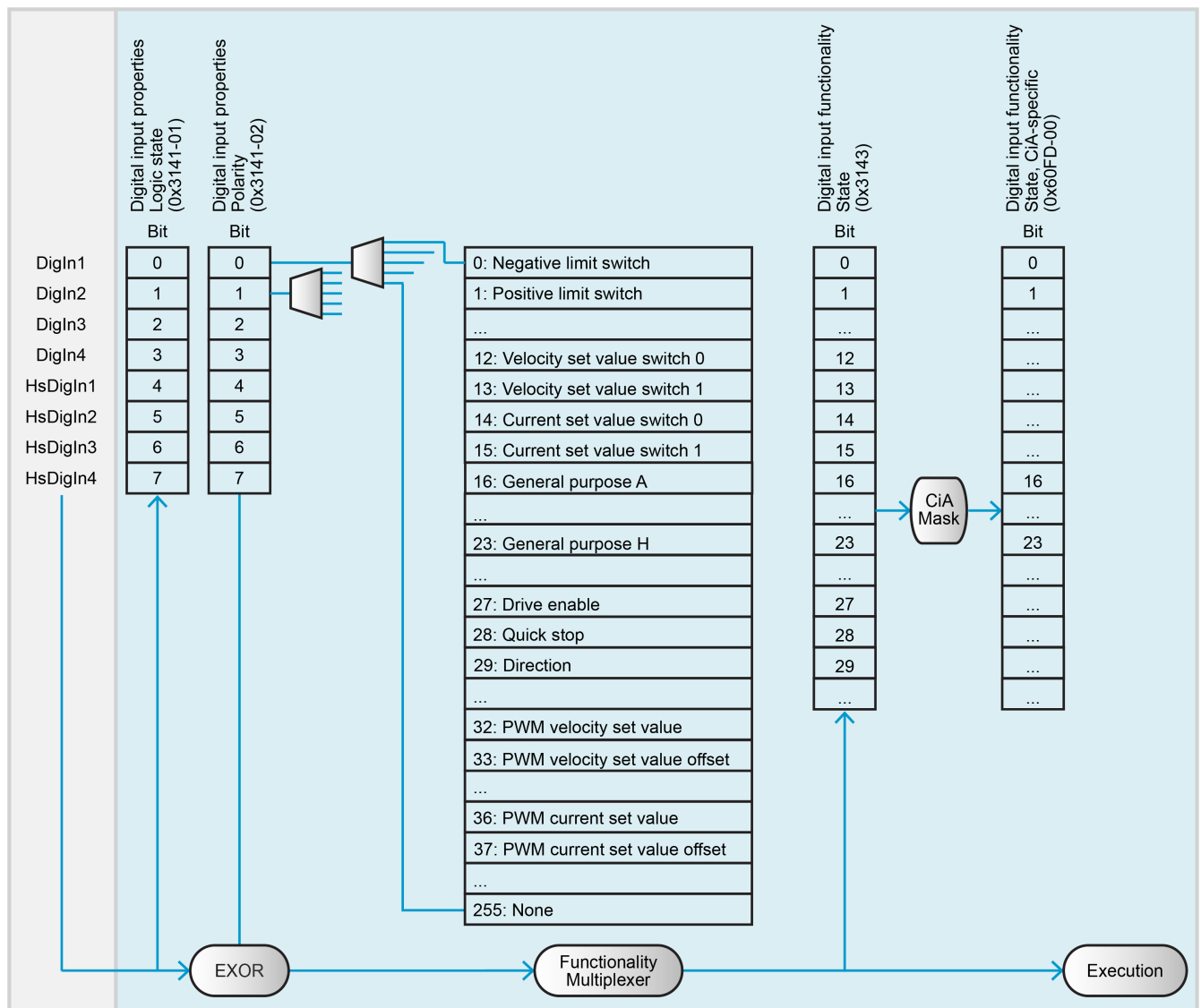

Figure 11. Digital input functionality

4.1.1. Digital input timing behavior

- **Software filter**

To prevent spikes, the digital inputs are filtered. The input level needs to stay steady for longer than the filter time in order to detect a state change (edge). The filter lengths are

- 1ms for "regular" digital inputs

- 500µs for high-speed digital inputs.

• **Update rates**

The digital input functionality states ([Digital inputs](#), [Digital inputs functionality](#)) and the [Digital input properties](#) are updated with 1 kHz.

4.2. Digital outputs

Predefined functions and general-purpose outputs are available for process control.

The configuration of the digital output functions is configured with [Configuration of digital outputs](#), while the polarity is modified with [Digital outputs polarity](#).

[Digital outputs](#) will be used to set the functionality state, and the logic state of the corresponding pin will be read using the [Digital outputs logic state](#).

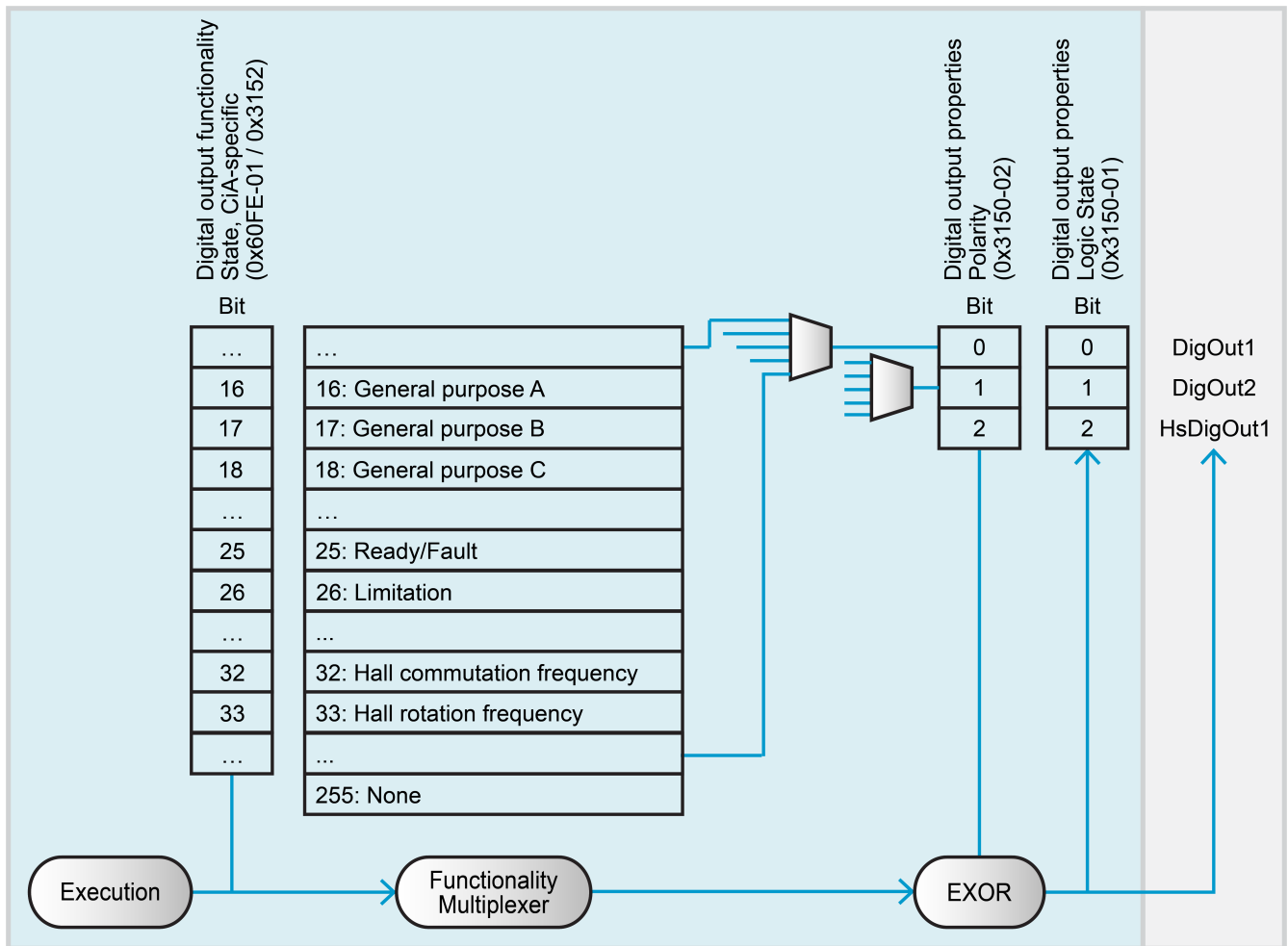

Figure 12. Digital output functionality

4.2.1. Digital output timing behavior

• **Update rates**

The [digital output logic states](#) are updated with 10 kHz. The functionality states [Physical outputs](#) are updated when written.

4.3. Analog inputs

The analog inputs may be used for general purpose process values, such as temperature, pressure, torque from

an external sensor, etc. The values are listed in [Analog input properties](#).

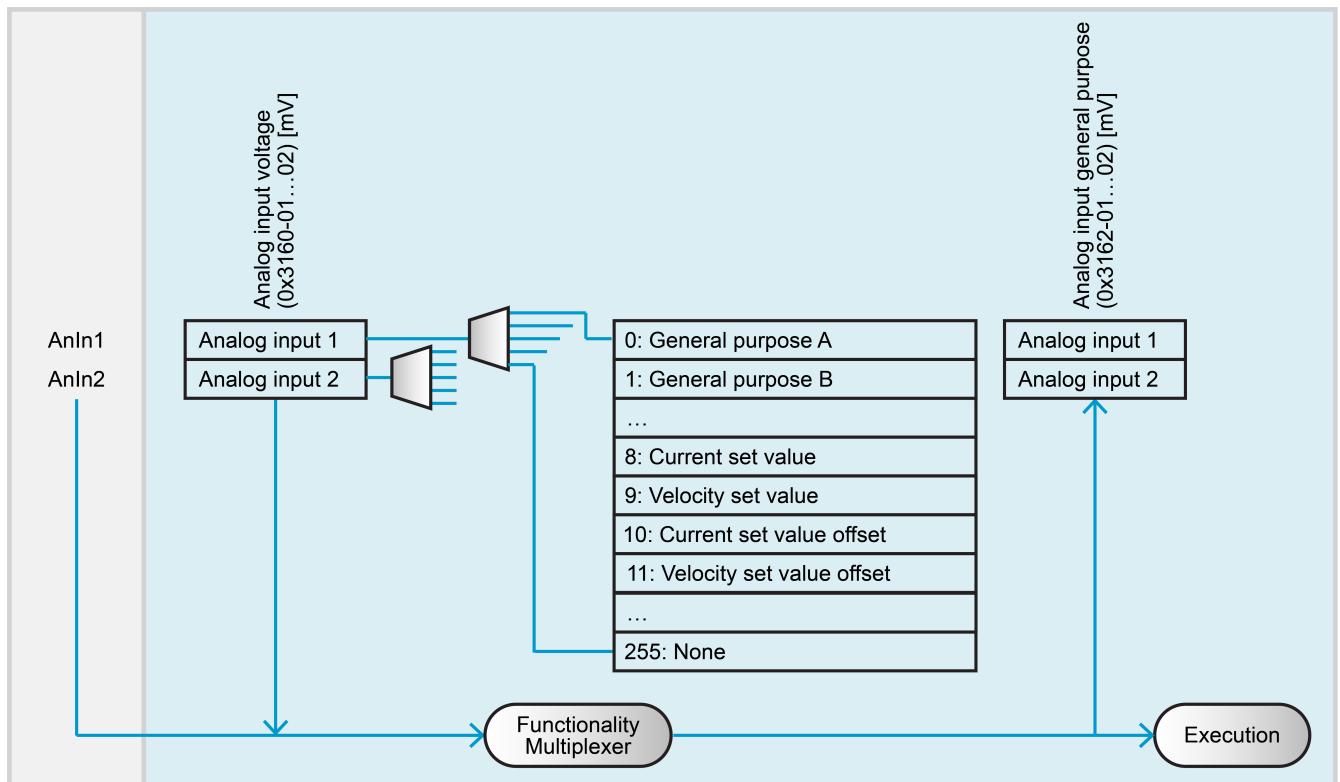

Figure 13. Analog input functionality

4.3.1. Analog input timing behavior

- **Update rates**

Only the [analog input properties](#) and [analog input raw values](#) are updated at 50 kHz. For further usage, these values are low pass filtered with a cut-off frequency of 10kHz.

Therefore, as an example, the following objects see a low pass filtered analog input voltage:

- [Analog input general purpose A](#)
- [Analog input general purpose B](#)
- [Velocity set value first voltage](#)
- [Velocity set value second voltage](#)
- [Current set value first voltage](#)
- [Current set value second voltage](#)
- ...

4.4. Analog outputs

The analog outputs are open to a variety of uses. These outputs are set by [Analog output general purpose](#) and displayed in [Analog output properties](#).

The configuration of analog output functions is done with [Configuration of analog outputs](#).

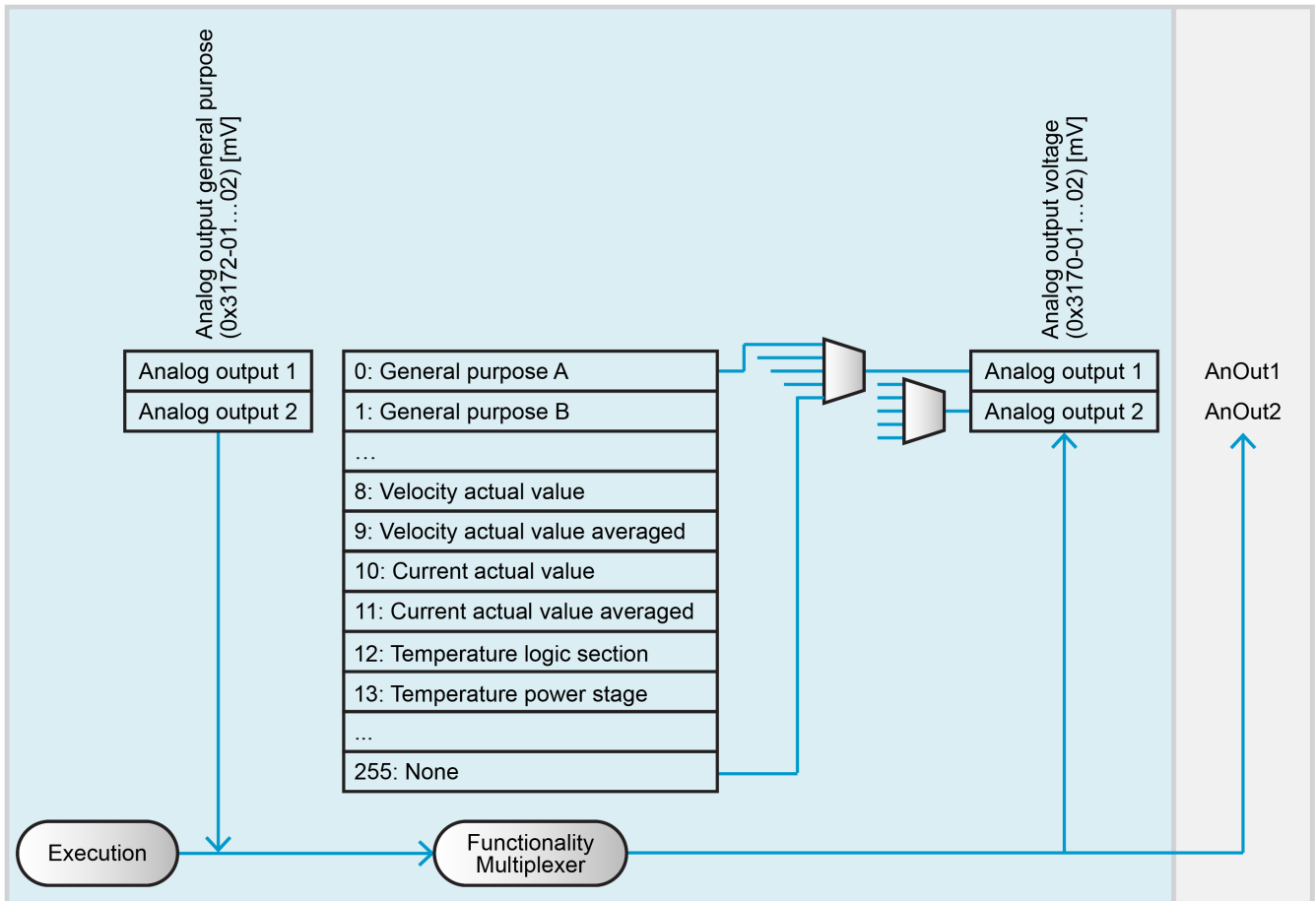

Figure 14. Analog output functionality

4.4.1. Analog output timing behavior

- **Update rates**

The [analog output properties](#) are updated at 50 kHz, according to the digital output logic. The functionality states [Analog output general purpose](#) are updated when written.

5. Communication

5.1. USB Communication

The device's USB interface follows the «Universal Serial Bus Specification Revision 2.0». The device always communicates as a slave.

6. Object dictionary

6.1. Overview

6.1.1. Object data types

Index	Name	Base type	Description	Size [Bits]	Range
0x0001	BOOLEAN	BOOL	False/True	1	0..1
0x0002	INTEGER8	SINT	Short Integer	8	$-2^7 \dots 2^7 - 1$
0x0003	INTEGER16	INT	Integer	16	$-2^{15} \dots 2^{15} - 1$
0x0004	INTEGER32	DINT	Double Integer	32	$-2^{31} \dots 2^{31} - 1$
0x0015	INTEGER64	LINT	Long Integer	64	$-2^{63} \dots 2^{63} - 1$
0x0005	UNSIGNED8	USINT	Unsigned Short Integer	8	$0 \dots 2^8 - 1$
0x0006	UNSIGNED16	UINT	Unsigned Integer	16	$0 \dots 2^{16} - 1$
0x0007	UNSIGNED32	UDINT	Unsigned Double Integer	32	$0 \dots 2^{32} - 1$
0x001B	UNSIGNED64	ULINT	Unsigned Long Integer	64	$0 \dots 2^{64} - 1$
0x0009	VISIBLE_STRING	STRING(n)	Visible String(1 octet per character)	8*n	–
0x000A	OCTET_STRING	ARRAY[0...n] of USINT	Sequence of octets (data type USINT)	8*(n+1)	–
0x0021	PDO_MAPPING	–	PDO mapping Parameter Record	–	–
0x0023	IDENTITY	–	Identity Parameter Record	–	–

Table 30. Object data types

6.1.2. Object codes

Object code	Object name
0x0007	VAR
0x0008	ARRAY
0x0009	RECORD

Table 31. Object codes

6.1.3. Object access types

Access type	Description
RW	read and write access
RO	read only access
WO	write only access
CONST	read only access value is constant

Table 32. Object access types

6.1.4. Object flags

Flag	Code	Description
PDO mapping	TXPDO, RXPDO	Entry can be mapped as TxPdo or as RxPdo
Backup	YES/NO	Entry can be stored/not stored in non-volatile memory

Table 33. Object flags

6.1.5. Entries overview

Index	Name	Object code
0x1000	Device type	VAR
0x1001	Error register	VAR
0x1003	Error history	ARRAY
0x1008	Manufacturer device name	VAR
0x1010	Store parameters	ARRAY
0x1011	Restore default parameters	ARRAY
0x1018	Identity object	RECORD
0x2100	Additional identity	RECORD
0x210C	Custom persistent memory	ARRAY
0x2200	Power supply	RECORD
0x2201	Power supply supervision	RECORD
0x2202	Thermal protection	RECORD
0x3000	Axis configuration	RECORD
0x3001	Motor data	RECORD
0x3002	Electrical system parameters	RECORD
0x3010	Digital incremental encoder S2	RECORD
0x301A	Digital Hall sensor S1	RECORD
0x30A0	Current control parameter set	RECORD
0x30A2	Velocity control parameter set	RECORD
0x30D0	Current demand value	VAR
0x30D1	Current actual values	ARRAY
0x30D2	Torque actual values	ARRAY
0x30D3	Velocity actual values	ARRAY
0x30F0	Target current	VAR
0x30F1	Current offset	VAR
0x3141	Digital input properties	RECORD
0x3142	Configuration of digital inputs	ARRAY
0x3143	Digital inputs functionality	VAR
0x3146	Velocity set value switch parameter	ARRAY
0x3147	Current set value switch parameter	ARRAY
0x314B	Digital input PWM frequencies	ARRAY
0x314C	Digital input PWM duty cycles	ARRAY
0x3150	Digital outputs properties	RECORD
0x3151	Configuration of digital outputs	ARRAY
0x3152	Digital outputs functionality	VAR
0x3160	Analog input properties	ARRAY
0x3161	Configuration of analog inputs	ARRAY
0x3162	Analog input general purpose	ARRAY
0x3163	Analog input adjustment	RECORD

Index	Name	Object code
0x3164	Analog input raw values	ARRAY
0x3170	Analog output properties	ARRAY
0x3171	Configuration of analog outputs	ARRAY
0x3172	Analog output general purpose	ARRAY
0x3180	Digital input PWM velocity set value scaling	RECORD
0x3181	Digital input PWM velocity set value offset scaling	RECORD
0x3184	Digital input PWM current set value scaling	RECORD
0x3185	Digital input PWM current set value offset scaling	RECORD
0x31B0	Analog input velocity set value scaling	RECORD
0x31B1	Analog input velocity set value offset scaling	RECORD
0x31B4	Analog input current set value scaling	RECORD
0x31B5	Analog input current set value offset scaling	RECORD
0x31C1	Analog output velocity scaling	RECORD
0x31C2	Analog output current scaling	RECORD
0x31C3	Analog output temperature scaling	RECORD
0x3200	Thermal protection motor	RECORD
0x3201	Thermal protection power stage	RECORD
0x3203	Motor control	RECORD
0x603F	Error code	VAR
0x6040	Controlword	VAR
0x6041	Statusword	VAR
0x6060	Modes of operation	VAR
0x6061	Modes of operation display	VAR
0x606B	Velocity demand value	VAR
0x606C	Velocity actual value	VAR
0x6076	Motor rated torque	VAR
0x6077	Torque actual value	VAR
0x607F	Max profile velocity	VAR
0x6080	Max motor speed	VAR
0x6083	Profile acceleration	VAR
0x6084	Profile deceleration	VAR
0x6085	Quick stop deceleration	VAR
0x60A9	SI unit velocity	VAR
0x60AA	SI unit acceleration	VAR
0x60B1	Velocity offset	VAR
0x60C5	Max acceleration	VAR
0x60E5	Additional velocity actual values	ARRAY
0x60FD	Digital inputs	VAR
0x60FE	Digital outputs	ARRAY
0x60FF	Target velocity	VAR

Index	Name	Object code
0x6402	Motor type	VAR
0x6502	Supported drive modes	VAR

Table 34. Object dictionary (overview)

6.2. Objects

6.2.1. Device type

Describes the device type. The lower word stands for the supported device profile number. The device adheres to CiA 402 "CANopen device profile for drives and motion control" if the value is 0x0192 (402). The higher word contains details about the drive type. Servo drives are those with the value 0x0002.

Name	Device type	
Index	0x1000	
Subindex	0x00	
Data type	UNSIGNED32	
Access type	RO	
Default value	0x00020192	
Value range	-	-
PDO mapping	NO	
Persistent	NO	

6.2.2. Error register

The error register for the device. The device maps internal errors in this byte.

Name	Error register	
Index	0x1001	
Subindex	0x00	
Data type	UNSIGNED8	
Access type	RO	
Default value	-	
Value range	Error Register Bits	
PDO mapping	NO	
Persistent	NO	

Bit	Description
7	Manufacturer specific
6	Reserved (always 0)
5	Device profile-specific
4	Communication error
3	Temperature error
2	Voltage error
1	Current error
0	Generic error

Table 35. Error Register Bits

6.2.3. Error history

Holds errors that have occurred on the device.

Name	Error history
Index	0x1003
Object code	ARRAY
Highest subindex supported	5

6.2.3.1. Number of errors

Contains the number of actual errors that are recorded in the array starting at subindex 1. Writing a "0" (zero) deletes the error history (empties the array). Values greater than "0" (zero) are permitted to write.

Name	Number of errors	
Index	0x1003	
Subindex	0x00	
Data type	UNSIGNED8	
Access type	RW	
Default value	0	
Value range	-	-
PDO mapping	NO	
Persistent	NO	

6.2.3.2. Error history 1

Every new error code is stored at subindex 1, the older ones move down the list. The error numbers compose of a 16-bit error code and 16-bit additional error information on higher word.

Errors without a device state change are marked with 0x8000 (bit31) in additional error information.

Name	Error history 1	
Index	0x1003	
Subindex	0x01	
Data type	UNSIGNED32	
Access type	RO	
Default value	-	
Value range	-	-
PDO mapping	NO	
Persistent	NO	

Bit	Value	Description
31	0	Error
	1	Warning (without effect on device states)
30...16	0	Reserved
15...0	Error code	Device error code

Table 36. Error history structure

6.2.3.3. Error history 2

Name	Error history 2	
Index	0x1003	
Subindex	0x02	
Data type	UNSIGNED32	
Access type	RO	
Default value	-	
Value range	-	-
PDO mapping	NO	
Persistent	NO	

6.2.3.4. Error history 3

Name	Error history 3	
Index	0x1003	
Subindex	0x03	
Data type	UNSIGNED32	
Access type	RO	
Default value	-	
Value range	-	-
PDO mapping	NO	
Persistent	NO	

6.2.3.5. Error history 4

Name	Error history 4	
Index	0x1003	
Subindex	0x04	
Data type	UNSIGNED32	
Access type	RO	
Default value	-	
Value range	-	-
PDO mapping	NO	
Persistent	NO	

6.2.3.6. Error history 5

Name	Error history 5	
Index	0x1003	
Subindex	0x05	
Data type	UNSIGNED32	
Access type	RO	
Default value	-	

Value range	-	-
PDO mapping	NO	
Persistent	NO	

6.2.4. Manufacturer device name

Holds the manufacturer device name.

Name	Manufacturer device name	
Index	0x1008	
Subindex	0x00	
Data type	VISIBLE_STRING	
Access type	RO	
Default value	ESCON2	
Value range	-	-
PDO mapping	NO	
Persistent	NO	

6.2.5. Store parameters

Controls saving of configuration parameters in a non-volatile memory.

Name	Store parameters	
Index	0x1010	
Object code	ARRAY	
Highest subindex supported	1	

In order to avoid storage of parameters by mistake, storage should only be executed when a specific signature is written to the respective subindex.

BYTE	MSB			LSB
Character	'e'	'v'	'a'	's'
Hex value	0x65	0x76	0x61	0x73

Table 37. Store Parameters Signature Values

On read access, the device will always return the value 0x00000001 since the device can only store the parameters on command.

Bit	RW	Description
31...2	X	Reserved
1 (auto)	1	The device saves parameters autonomously
	0	The device does not save parameters autonomously
0 (cmd)	1	The device saves parameters on command
	0	The device does not save parameters on command

Table 38. Store Parameters State Values

6.2.5.1. Save all parameters

In the event that the code "save" is written to the object, all device parameters will be saved in a non-volatile memory.

Name	Save all parameters
Index	0x1010
Subindex	0x01
Data type	UNSIGNED32
Access type	RW
Default value	0x00000001
Value range	Store Parameters Signature Values
PDO mapping	NO
Persistent	NO

6.2.6. Restore default parameters

Configuration parameters are restored to the default values. Restoring the default parameters is permitted in NMT state «Pre-Operational» and device state «Power Disable» (see [Device control](#)) only. The default values are only set as valid after the device is reset or power cycled.

Name	Restore default parameters
Index	0x1011
Object code	ARRAY
Highest subindex supported	1

In order to avoid restoring of default parameters by mistake, restoring should only be executed when a specific signature is written to the respective subindex. On read access, the device will always return the value 0x00000001.

BYTE	MSB			LSB
Character	'd'	'a'	'o'	'l'
Hex value	0x64	0x61	0x6F	0x6C

Table 39. Restore default parameters signature values

6.2.6.1. Restore all default parameters

All parameters of the device will be stored in non-volatile memory if the code "load" is written to the object. Only permitted if device state is "Power Disable" (see [Device control](#)).

Name	Restore all default parameters
Index	0x1011
Subindex	0x01
Data type	UNSIGNED32
Access type	RW
Default value	0x00000001
Value range	Restore default parameters signature values
PDO mapping	NO

Persistent	NO
------------	----

6.2.7. Identity object

Provides general identification information on the device.

Name	Identity object
Index	0x1018
Object code	RECORD
Highest subindex supported	4

6.2.7.1. Vendor ID

Unique "maxon motor ag" vendor identification defined by CiA.

Name	Vendor ID
Index	0x1018
Subindex	0x01
Data type	UNSIGNED32
Access type	RO
Default value	0x000000FB
Value range	-
PDO mapping	NO
Persistent	NO

6.2.7.2. Product code

The high word contains the hardware version. The low word contains the application number.

Name	Product code
Index	0x1018
Subindex	0x02
Data type	UNSIGNED32
Access type	RO
Default value	-
Value range	-
PDO mapping	NO
Persistent	NO

Hardware version	Hardware
0x1101	ESCON2 Module 60/30 ESCON2 Compact 60/30
0x1102	ESCON2 Micro 60/5
0x1103	ESCON2 Nano 24/2

Table 40. Definition of hardware version

6.2.7.3. Revision number

The high word contains the software version. The low word contains the application version.

Name	Revision number	
Index	0x1018	
Subindex	0x03	
Data type	UNSIGNED32	
Access type	RO	
Default value	-	
Value range	-	-
PDO mapping	NO	
Persistent	NO	

6.2.7.4. Serial number

Contains the last 8 digits of the device serial number.

Related object: [Serial number complete](#)

Name	Serial number	
Index	0x1018	
Subindex	0x04	
Data type	UNSIGNED32	
Access type	RO	
Default value	-	
Value range	-	-
PDO mapping	NO	
Persistent	NO	

6.2.8. Additional identity

Name	Additional identity	
Index	0x2100	
Object code	RECORD	
Highest subindex supported	1	

6.2.8.1. Serial number complete

Contains the full 64-bit device serial number.

Name	Serial number complete	
Index	0x2100	
Subindex	0x01	
Data type	UNSIGNED64	
Access type	RO	
Default value	-	
Value range	-	-

PDO mapping	NO
Persistent	NO

6.2.9. Custom persistent memory

Name	Custom persistent memory
Index	0x210C
Object code	ARRAY
Highest subindex supported	4

6.2.9.1. Custom persistent memory 1

Can be used to store custom values (for example, axis numbers, identifications, etc.) on the device. The stored values are not evaluated by the firmware although the set parameters are restored to default values.

Related object: [Restore default parameters](#).

Name	Custom persistent memory 1
Index	0x210C
Subindex	0x01
Data type	UNSIGNED32
Access type	RW
Default value	0x00000000
Value range	-
PDO mapping	NO
Persistent	YES

6.2.9.2. Custom persistent memory 2

Name	Custom persistent memory 2
Index	0x210C
Subindex	0x02
Data type	UNSIGNED32
Access type	RW
Default value	0x00000000
Value range	-
PDO mapping	NO
Persistent	YES

6.2.9.3. Custom persistent memory 3

Name	Custom persistent memory 3
Index	0x210C
Subindex	0x03
Data type	UNSIGNED32
Access type	RW
Default value	0x00000000

Value range	-	-
PDO mapping	NO	
Persistent	YES	

6.2.9.4. Custom persistent memory 4

Name	Custom persistent memory 4	
Index	0x210C	
Subindex	0x04	
Data type	UNSIGNED32	
Access type	RW	
Default value	0x00000000	
Value range	-	-
PDO mapping	NO	
Persistent	YES	

6.2.10. Power supply

Used to display the power supply parameters.

Name	Power supply	
Index	0x2200	
Object code	RECORD	
Highest subindex supported	1	

6.2.10.1. Power supply voltage

Represents the actual power supply voltage. The value is given as [0.1 V].

Note:



If the device is only powered via the logic supply, the displayed value is to be considered invalid.

Name	Power supply voltage	
Index	0x2200	
Subindex	0x01	
Data type	UNSIGNED16	
Access type	RO	
Default value	-	
Value range	-	-
PDO mapping	NO	
Persistent	NO	

6.2.11. Power supply supervision

Used to customize power supervision.

Name	Power supply supervision
Index	0x2201
Object code	RECORD
Highest subindex supported	2

6.2.11.1. Power supply undervoltage limit

The device can only be enabled if the supply voltage is higher than the [undervoltage limit](#). If the supply voltage falls below this undervoltage limit while the device is enabled, the [Undervoltage error](#) will be set. The error can only be cleared if the supply voltage rises above the sum of the [undervoltage limit](#) plus the [undervoltage hysteresis](#).

The [undervoltage limit](#) must be lower than [overvoltage limit](#) minus [overvoltage hysteresis](#) minus [undervoltage hysteresis](#).

The value is given in [mV].

Name	Power supply undervoltage limit
Index	0x2201
Subindex	0x01
Data type	UNSIGNED32
Access type	RW
Default value	Power supply - undervoltage limit
Value range	Power supply - undervoltage limit
PDO mapping	NO
Persistent	YES

Hardware	Default	Min	Max
ESCON2 Module 60/30 ESCON2 Compact 60/30	7'500mV	7'500mV	63'750mV
ESCON2 Micro 60/5	7'500mV	7'500mV	63'750mV
ESCON2 Nano 24/2	4'500mV	4'500mV	29'000mV

Table 41. Power supply - undervoltage limit

Hardware	Undervoltage hysteresis
ESCON2 Module 60/30 ESCON2 Compact 60/30	250mV
ESCON2 Micro 60/5	250mV
ESCON2 Nano 24/2	50mV

Table 42. Power supply - undervoltage hysteresis

6.2.11.2. Power supply overvoltage limit

If the supply voltage rises above this overvoltage limit (regardless of the enabled state), the [Overvoltage error](#) will be set. The error can only be cleared if the supply voltage falls below the [overvoltage limit](#) minus the [overvoltage hysteresis](#).

The [overvoltage limit](#) must be higher than [undervoltage limit](#) plus [undervoltage hysteresis](#) plus [overvoltage hysteresis](#).

The value is given in [mV].

Name	Power supply overvoltage limit
------	--------------------------------

Index	0x2201
Subindex	0x02
Data type	UNSIGNED32
Access type	RW
Default value	Power supply - overvoltage limit
Value range	Power supply - overvoltage limit
PDO mapping	NO
Persistent	YES

Hardware	Default	Min	Max
ESCON2 Module 60/30 ESCON2 Compact 60/30	65'000mV	8'750mV	65'000mV
ESCON2 Micro 60/5	65'000mV	8'750mV	65'000mV
ESCON2 Nano 24/2	31'000mV	4'550mV	31'000mV

Table 43. Power supply - overvoltage limit

Hardware	Overvoltage hysteresis
ESCON2 Module 60/30 ESCON2 Compact 60/30	1'000mV
ESCON2 Micro 60/5	1'000mV
ESCON2 Nano 24/2	2'000mV

Table 44. Power supply - overvoltage hysteresis

6.2.12. Thermal protection

Name	Thermal protection
Index	0x2202
Object code	RECORD
Highest subindex supported	1

6.2.12.1. Temperature logic section

Displays the logic section temperature. [Thermal logic section overload error](#) will be set if the logic section temperature exceeds the [over temperature limit](#). The temperature must drop below [temperature limit](#) minus the [temperature hysteresis](#), in order to clear the error. The value is given in [0.1 °C].

Name	Temperature logic section
Index	0x2202
Subindex	0x01
Data type	INTEGER16
Access type	RO
Default value	-
Value range	-
PDO mapping	TXPDO
Persistent	NO

Hardware	Temperature limit
ESCON2 Module 60/30 ESCON2 Compact 60/30	108°C
ESCON2 Micro 60/5	115°C
ESCON2 Nano 24/2	108°C

Table 45. Logic section over temperature limit

Hardware	Hysteresis
ESCON2 Module 60/30 ESCON2 Compact 60/30	10°C
ESCON2 Micro 60/5	10°C
ESCON2 Nano 24/2	10°C

Table 46. Logic section over temperature hysteresis

6.2.13. Axis configuration

Used to setup the main components of the axis by configuring the sensors and the control structure. Write access is only permitted in the device state «Power Disable» (see [Device control](#)).

Related objects: [Motor type](#)

Name	Axis configuration
Index	0x3000
Object code	RECORD
Highest subindex supported	5

6.2.13.1. Sensors configuration

Used to define the sensor types used for the axis.

- If [Motor type](#) is set to “brushed DC motor”, the field value “Digital Hall sensor” is set to “none”, and cannot be set to another value.

Related objects: [Digital incremental encoder S2](#), [Digital Hall sensor S1](#)

Name	Sensors configuration
Index	0x3000
Subindex	0x01
Data type	UNSIGNED32
Access type	RW
Default value	0x00000110
Value range	Sensor configuration - Bits
PDO mapping	NO
Persistent	YES

Bit	Name	Value	Description
31..16	Reserved	0x00	–

Bit	Name	Value	Description
15..8	Sensor 2 type	0x00	None
		0x01	Digital incremental encoder
7..0	Sensor 1 type	0x00	None
		0x10	Digital Hall Sensor (EC motors only)

Table 47. Sensor configuration - Bits

Note:	
	For detailed information on socket and pin assignment, see the separate document «Hardware Reference» Documentation structure of the respective controller.

6.2.13.2. Control structure

Defines the control structure of the axis depending on the available sensors.

- The main sensor can only be selected if the corresponding value of [Sensors configuration](#) has been configured (i.e, not "None").
- Take into account that the control quality depends, among other factors, on the resolution of the main sensor.
- If the values in [Commutation sensors](#) are incompatible with the new control structure, [Commutation sensors](#) is set to 0 (no commutation sensors configured).

Name	Control structure
Index	0x3000
Subindex	0x02
Data type	UNSIGNED32
Access type	RW
Default value	0x00020011
Value range	Control structure - Bits and Control structure - value range
PDO mapping	NO
Persistent	YES

Bit	Name	Value	Description
31..20	Reserved	0x00	–
19..16	Main Sensor	0x00	None
		0x01	Sensor 1
		0x02	Sensor 2
15..8	Reserved	0x00	–
7..4	Velocity control structure	0x00	None
		0x01	PI velocity controller (low-pass filter)
3..0	Current Control Structure	0x01	PI current controller

Table 48. Control structure - Bits

Value (hex)	Description	DC	EC
0x0000'0001	PI current controller No velocity controller No main sensor	x	x
0x0001'0011	PI current controller PI velocity controller (low-pass filter) Sensor 1 is main sensor	-	x
0x0002'0011	PI current controller PI velocity controller (low-pass filter) Sensor 2 is main sensor	x	x

Table 49. Control structure - value range

Note:	
	Speed limitation in current-based modes of operation is only supported if the main sensor is configured (not None). In this case, the Velocity control parameter set must be configured or tuned.

6.2.13.3. Commutation sensors

Defines the control structure of the axis dependent on the available sensors and their disposition, as well as the commutation sensors for the axis motor.

In the case of a "brushed DC motor", the value is ignored.

For "brushless DC motor", the entry may not be set to 0x0000 (no commutation sensor defined). "Sensor commutation absolute" is used for sensors that do not require additional alignment to perform commutation (e.g, digital Hall sensors). In contrast, "Sensor commutation relative" is used if additional algorithms are required to use the sensor as a commutation sensor (e.g, digital incremental encoder). Combinations of both relative and absolute commutation sensors are possible.

- Only if the relevant value of [Sensors configuration](#) is configured (i.e., not "None") may "Sensor commutation absolute" or "Sensor commutation relative" be chosen.
- A sensor must be installed on the motor shaft if it is to be utilized as a commutation sensor.
- The object [Control structure](#) is reset to 0x0000 (no commutation sensor defined) if it is written to and the new value is incompatible with the current setup. Enabling the axis will yield an error until a valid configuration is selected.

Name	Commutation sensors
Index	0x3000
Subindex	0x03
Data type	UNSIGNED32
Access type	RW
Default value	0x00000012
Value range	Commutation sensors - Bits and Commutation sensors - value range
PDO mapping	NO
Persistent	YES

Bit	Name	Value	Description
31..8	Reserved	0x00	–
7..4	Commutation Sensor Absolute	0x00	None
		0x01	Sensor 1

Bit	Name	Value	Description
3..0	Commutation Sensor Relative	0x00	None
		0x02	Sensor 2

Table 50. Commutation sensors - Bits

Value	Description	Motor type supported
0x0000'0000	No commutation sensor defined	DC motor
0x0000'0010	Sensor 1 used for commutation [a]	EC motor
0x0000'0012	Sensor 1 and Sensor 2 used for commutation [a]	EC motor

[a] The value can only be set if a supported motor type is selected [Motor type](#)

Table 51. Commutation sensors - value range

6.2.13.4. Axis configuration miscellaneous

Used to define various options regarding the axis configuration.

Name	Axis configuration miscellaneous
Index	0x3000
Subindex	0x04
Data type	UNSIGNED32
Access type	RW
Default value	0x00000000
Value range	Axis configuration miscellaneous – Bits
PDO mapping	NO
Persistent	YES

Bit	Name	Value	Description
31..10	Reserved	0	-
9	Commutation sensor supervision	1	Commutation sensor supervision is disabled
		0	Commutation sensor supervision is enabled
8	Main sensor supervision	1	Main sensor supervision is disabled
		0	Main sensor supervision is enabled
7..1	Reserved	0	-
0	Axis polarity	1	Inverse polarity – rotational direction of the axis is CW when positive demand values are attached.
		0	Normal polarity – rotational direction of the axis is CCW when positive demand values are attached.

Table 52. Axis configuration miscellaneous – Bits

6.2.13.5. Main sensor resolution

Displays the resolution of the main sensor given in [increments/revolution].

Name	Main sensor resolution
Index	0x3000
Subindex	0x05

Data type	UNSIGNED32	
Access type	RO	
Default value	-	
Value range	-	-
PDO mapping	NO	
Persistent	NO	

6.2.14. Motor data

Used to configure the parameters of the motor.

Some parameters are used to limit the output current according to the I2t method. For detailed motor specifications, see maxon catalog.

Related object: [Motor type](#)

Name	Motor data
Index	0x3001
Object code	RECORD
Highest subindex supported	5

6.2.14.1. Nominal current

Represents the nominal current of the motor [mA].

Continuous operation of the motor at this current level and at 25 °C ambient will ultimately cause the winding to reach the specified maximum winding temperature. This assumes no heat sink. The value can be substantially increased if the motor mount is made of heat-dissipating materials.

Related object: [Motor rated torque](#)

Name	Nominal current
Index	0x3001
Subindex	0x01
Data type	UNSIGNED32
Access type	RW
Default value	Nominal current
Value range	Nominal current
PDO mapping	RXPDO
Persistent	YES

Hardware	Default	Min	Max
ESCON2 Module 60/30 ESCON2 Compact 60/30	30'000mA	0mA	30'000mA
ESCON2 Micro 60/5	5'000mA	0mA	5'000mA
ESCON2 Nano 24/2	2'000mA	0mA	2'000mA

Table 53. Nominal current

6.2.14.2. Output current limit

Represents the maximum permissible current of the motor [mA].

We recommend setting the value to double [Nominal current](#).

Related object: [Thermal time constant winding](#)

Name	Output current limit
Index	0x3001
Subindex	0x02
Data type	UNSIGNED32
Access type	RW
Default value	Output current limit
Value range	Output current limit
PDO mapping	RXPDO
Persistent	YES

Hardware	Default	Min	Max
ESCON2 Module 60/30 ESCON2 Compact 60/30	6'000mA	0mA	6'000mA
ESCON2 Micro 60/5	15'000mA	0mA	15'000mA
ESCON2 Nano 24/2	6'000mA	0mA	6'000mA

Table 54. Output current limit

6.2.14.3. Number of pole pairs

Represents the number of magnetic pole pairs (number of poles divided by 2) of the rotor of a brushless DC motor (maxon EC motor/BLDC motor).

Write access is only permitted in device state «Power disabled»: [Device control](#).

Related object: [Max motor speed](#)

Name	Number of pole pairs		
Index	0x3001		
Subindex	0x03		
Data type	UNSIGNED8		
Access type	RW		
Default value	1		
Value range	1	255	
PDO mapping	NO		
Persistent	YES		

6.2.14.4. Thermal time constant winding

Represents the thermal time constant of the motor winding. It is used to calculate the length of time the [Output current limit](#) is permitted to be connected to the motor. The value is given in [0.1 s].

Name	Thermal time constant winding		
Index	0x3001		
Subindex	0x04		
Data type	UNSIGNED16		
Access type	RW		
Default value	40		
Value range	1	10'000	

PDO mapping	NO
Persistent	YES

6.2.14.5. Torque constant

Represents the motor's torque constant. The value is given in [$\mu\text{Nm/A}$].
Write access is only permitted in device state «Power Disabled»: [Device control](#).
Related object: [Motor rated torque](#)

Name	Torque constant	
Index	0x3001	
Subindex	0x05	
Data type	UNSIGNED32	
Access type	RW	
Default value	0	
Value range	0	10'000'000
PDO mapping	NO	
Persistent	YES	

6.2.15. Electrical system parameters

The parameters are evaluated during the regulation, tuning, and identification of the electrical system. They are used during the regulation tuning identification of the mechanical system to calculate the torque constant as well as for sensor supervision.

Name	Electrical system parameters	
Index	0x3002	
Object code	RECORD	
Highest subindex supported	2	

6.2.15.1. Electrical resistance

Represents the electrical system's resistance. The value is given in [$\text{m}\Omega$].

Name	Electrical resistance	
Index	0x3002	
Subindex	0x01	
Data type	UNSIGNED32	
Access type	RW	
Default value	0	
Value range	-	-
PDO mapping	NO	
Persistent	YES	

6.2.15.2. Electrical inductance

Represents the electrical system's inductance. The value is given in [μH].

Name	Electrical inductance	
------	-----------------------	--

Index	0x3002	
Subindex	0x02	
Data type	UNSIGNED16	
Access type	RW	
Default value	0	
Value range	-	-
PDO mapping	NO	
Persistent	YES	

6.2.16. Digital incremental encoder S2

Defines the configuration of the digital incremental encoder for sensor 2 (S2).

Related object: [Sensors configuration](#)

Name	Digital incremental encoder S2	
Index	0x3010	
Object code	RECORD	
Highest subindex supported	2	

6.2.16.1. Digital incremental encoder number of pulses

Defines the resolution of the digital incremental encoder. The value is given in [pulses/revolution]. Unit conversion is as follows:

$$4 * \frac{\text{pulses}}{\text{revolutions}} = \frac{\text{increments}[\text{inc}]}{\text{revolutions}[\text{rev}]} = \frac{\text{quadcounts}[\text{qc}]}{\text{revolutions}[\text{rev}]}$$

Write access is only permitted in device state «Power Disabled»: [Device control](#).

Name	Digital incremental encoder number of pulses	
Index	0x3010	
Subindex	0x01	
Data type	UNSIGNED32	
Access type	RW	
Default value	500	
Value range	16	2'500'000
PDO mapping	NO	
Persistent	YES	

6.2.16.2. Digital incremental encoder type

Defines the configuration of the digital incremental encoder.

Write access is only permitted in device state «Power Disabled»: [Device control](#). Non-zero writes to reserved bits are not allowed. In this case, an abort code is returned.

Name	Digital incremental encoder type	
Index	0x3010	
Subindex	0x02	

Data type	UNSIGNED16
Access type	RW
Default value	0x0000
Value range	Digital incremental encoder type – Bits
PDO mapping	NO
Persistent	YES

Bit	Name	Value	Description
15...10	Reserved	0	–
9	Method	0	Speed measured as time between two sensor edges
		1	Speed measured as number of sensor edges per control cycle
8...5	Reserved	0	–
4	Direction	0	maxon
		1	Inverted (or encoder mounted on motor shaft)
3...2	Reserved	0	–
1...0	Index	0	Encoder without index (2-channel)
		1...3	Reserved

Table 55. Digital incremental encoder type – Bits

6.2.17. Digital Hall sensor S1

Defines the configuration of the digital Hall sensor for sensor 1 (S1). Make sure to activate the digital Hall sensor using [Axis configuration](#).

Name	Digital Hall sensor S1
Index	0x301A
Object code	RECORD
Highest subindex supported	2

6.2.17.1. Digital Hall sensor type

Defines the configuration of the digital Hall sensor.

Write access is only permitted in device state «Power Disabled»: [Device control](#). Non-zero writes to reserved bits are not allowed. In this case, an abort code is returned.

Name	Digital Hall sensor type
Index	0x301A
Subindex	0x01
Data type	UNSIGNED16
Access type	RW
Default value	0x0000
Value range	Digital hall sensor type – bits
PDO mapping	NO
Persistent	YES

Bit	Name	Value	Description
15...5	Reserved	-	–
4	Method	0	Speed measured as time between two sensor edges
		1	Speed measured as number of sensor edges per control cycle
3...1	Reserved	-	–
0	Polarity	0	maxon
		1	Inverted

Table 56. Digital hall sensor type – bits

6.2.17.2. Digital Hall sensor pattern

Displays the actual state of the three digital Hall sensors as a pattern.

Name	Digital Hall sensor pattern	
Index	0x301A	
Subindex	0x02	
Data type	UNSIGNED16	
Access type	RO	
Default value	-	
Value range	-	-
PDO mapping	NO	
Persistent	NO	

Bit	Name
2	Digital Hall sensor 3
1	Digital Hall sensor 2
0	Digital Hall sensor 1

Table 57. Digital hall sensor pattern – bits

6.2.18. Current control parameter set

Holds the current controller parameters. The current controller is a digital PI controller.

Name	Current control parameter set
Index	0x30A0
Object code	RECORD
Highest subindex supported	2

6.2.18.1. Current controller P gain

Represents the proportional gain of the current controller. The value is given in

$$\left[\frac{\mu V}{A} \right]$$

Name	Current controller P gain
Index	0x30A0

Subindex	0x01
Data type	UNSIGNED32
Access type	RW
Default value	1'171'880
Value range	-
PDO mapping	RXPDO
Persistent	YES

6.2.18.2. Current controller I gain

Represents the integral gain of the current controller. The value is given in

$$\left[\frac{\mu V}{A \cdot ms} \right]$$

Name	Current controller I gain
Index	0x30A0
Subindex	0x02
Data type	UNSIGNED32
Access type	RW
Default value	3'906'250
Value range	-
PDO mapping	RXPDO
Persistent	YES

6.2.19. Velocity control parameter set

Velocity regulation is implemented with a digital PI controller. The object holds all the parameters of the velocity controller.

Name	Velocity control parameter set
Index	0x30A2
Object code	RECORD
Highest subindex supported	5

6.2.19.1. Velocity controller P gain

Represents the proportional gain of the velocity controller. The value is given in

$$\left[\frac{\mu A \cdot s}{rad} \right]$$

Name	Velocity controller P gain
Index	0x30A2
Subindex	0x01
Data type	UNSIGNED32
Access type	RW

Default value	20'000	
Value range	-	-
PDO mapping	RXPDO	
Persistent	YES	

6.2.19.2. Velocity controller I gain

Represents the integral gain of the velocity controller. The value is given in

$$\left[\frac{\mu A}{rad} \right]$$

Name	Velocity controller I gain	
Index	0x30A2	
Subindex	0x02	
Data type	UNSIGNED32	
Access type	RW	
Default value	500'000	
Value range	-	-
PDO mapping	RXPDO	
Persistent	YES	

6.2.19.3. Velocity controller FF velocity gain

Represents the speed feedforward gain of the velocity controller. The value is given in

$$\left[\frac{\mu A \cdot s}{rad} \right]$$

Name	Velocity controller FF velocity gain	
Index	0x30A2	
Subindex	0x03	
Data type	UNSIGNED32	
Access type	RW	
Default value	0	
Value range	-	-
PDO mapping	RXPDO	
Persistent	YES	

6.2.19.4. Velocity controller FF acceleration gain

Represents the acceleration feedforward gain of the velocity controller. The value is given in

$$\left[\frac{\mu A \cdot s^2}{rad} \right]$$

Name	Velocity controller FF acceleration gain	
------	--	--

Index	0x30A2	
Subindex	0x04	
Data type	UNSIGNED32	
Access type	RW	
Default value	0	
Value range	-	-
PDO mapping	RXPDO	
Persistent	YES	

6.2.19.5. Velocity controller filter cut-off frequency

Represents the velocity low-pass filter cut-off frequency of the velocity controller. The value is given in [Hz].

Name	Velocity controller filter cut-off frequency	
Index	0x30A2	
Subindex	0x05	
Data type	UNSIGNED16	
Access type	RW	
Default value	600	
Value range	1	10'000
PDO mapping	NO	
Persistent	YES	

6.2.20. Current demand value

The set value for the current controller. The value is given in [mA].

Name	Current demand value	
Index	0x30D0	
Subindex	0x00	
Data type	INTEGER32	
Access type	RO	
Default value	-	
Value range	-	-
PDO mapping	TXPDO	
Persistent	NO	

6.2.21. Current actual values

Provides the actual current values.

Name	Current actual values	
Index	0x30D1	
Object code	ARRAY	
Highest subindex supported	2	

6.2.21.1. Current actual value averaged

Represents the [Current actual value](#) filtered by 1st order digital low-pass filter with a cutoff frequency of 50 Hz. The value is given in [mA].

Name	Current actual value averaged	
Index	0x30D1	
Subindex	0x01	
Data type	INTEGER32	
Access type	RO	
Default value	-	
Value range	-	-
PDO mapping	TXPDO	
Persistent	NO	

6.2.21.2. Current actual value

Provides the actual value of the motor's current. The value is given in [mA].

Name	Current actual value	
Index	0x30D1	
Subindex	0x02	
Data type	INTEGER32	
Access type	RO	
Default value	-	
Value range	-	-
PDO mapping	TXPDO	
Persistent	NO	

6.2.22. Torque actual values

Provides the actual torque values.

Name	Torque actual values	
Index	0x30D2	
Object code	ARRAY	
Highest subindex supported	1	

6.2.22.1. Torque actual value averaged

Represents the [Torque actual value](#) filtered by 1st order digital low-pass filter with a cutoff frequency of 50 Hz. The value is given in

$$\left[\frac{\text{MotorRatedTorque}}{1000} \right]$$

Related object: [Torque actual value](#)

Name	Torque actual value averaged	
------	------------------------------	--

Index	0x30D2	
Subindex	0x01	
Data type	INTEGER16	
Access type	RO	
Default value	-	
Value range	-	-
PDO mapping	TXPDO	
Persistent	NO	

6.2.23. Velocity actual values

Name	Velocity actual values	
Index	0x30D3	
Object code	ARRAY	
Highest subindex supported	1	

6.2.23.1. Velocity actual value averaged

Represents the [Velocity actual value](#) filtered by a 1-st order digital low-pass filter with a cutoff frequency of 5 Hz. Provides the actual averaged velocity value of the axis, derived by the main sensor defined in [Axis configuration](#). If no main sensor is configured, an estimated velocity is displayed. The value is given in [\[velocity units\]](#).

Related objects: [Velocity actual value](#), [Additional velocity actual values](#)

Name	Velocity actual value averaged	
Index	0x30D3	
Subindex	0x01	
Data type	INTEGER32	
Access type	RO	
Default value	-	
Value range	-	-
PDO mapping	TXPDO	
Persistent	NO	

6.2.24. Target current

Indicates the configured input value for the current controller in [I/O Current Mode \(IOCM\)](#). The value is given in [\[mA\]](#).

Name	Target current	
Index	0x30F0	
Subindex	0x00	
Data type	INTEGER32	
Access type	RW	
Default value	0	
Value range	-	-
PDO mapping	NO	

Persistent	NO
------------	----

6.2.25. Current offset

Indicates the configured input offset value for the current controller in [I/O Current Mode \(IOCM\)](#). The value is given in [mA].

Name	Current offset
Index	0x30F1
Subindex	0x00
Data type	INTEGER32
Access type	RW
Default value	0
Value range	-
PDO mapping	NO
Persistent	NO

6.2.26. Digital input properties

Related objects: [Configuration of digital inputs](#), [Digital inputs functionality](#), [Digital inputs](#)

Name	Digital input properties
Index	0x3141
Object code	RECORD
Highest subindex supported	2

6.2.26.1. Digital inputs logic state

Displays the state of the digital input logic signal (before polarity correction). A bit is read as "1" if the signal at the corresponding pin is high.

If sensor 2 is configured ([Sensors configuration](#)), the bits corresponding to high-speed digital inputs 1 to 4 will be zero. The status is also zero if a PWM input functionality ([Digital input 1 configuration](#)) is configured on the corresponding input.

Name	Digital inputs logic state
Index	0x3141
Subindex	0x01
Data type	UNSIGNED16
Access type	RO
Default value	-
Value range	-
PDO mapping	TXPDO
Persistent	NO

Bit	Default value
7	High-speed digital input 4
6	High-speed digital input 3

Bit	Default value
5	High-speed digital input 2
4	High-speed digital input 1
3	Digital input 4
2	Digital input 3
1	Digital input 2
0	Digital input 1

Table 58. Digital input bits

6.2.26.2. Digital inputs polarity

Used to set the polarity of the digital input functionalities. If a bit is set to "0" (zero), the associated pin is active-high. The polarity setting has no effect if a PWM input functionality ([Digital input 1 configuration](#)) is configured on the corresponding input.

For bit description see table [Digital input bits](#).

Related objects: [Digital inputs functionality](#), [Digital inputs](#).

Name	Digital inputs polarity	
Index	0x3141	
Subindex	0x02	
Data type	UNSIGNED16	
Access type	RW	
Default value	0x0000	
Value range	-	-
PDO mapping	NO	
Persistent	YES	

6.2.27. Configuration of digital inputs

Configures the functionality that will be assigned to digital inputs.

If sensor 2 is configured ([Sensors configuration](#)), the high-speed digital inputs 1 to 4 will be disabled. This configuration cannot be overridden as long as sensor 2 is configured.

Related objects: [Digital input properties](#), [Digital inputs functionality](#), [Digital inputs](#)

Name	Configuration of digital inputs
Index	0x3142
Object code	ARRAY
Highest subindex supported	8

6.2.27.1. Digital input 1 configuration

Maps functions to digital inputs. Each function can only be mapped once, and each digital input can only hold one function.

Name	Digital input 1 configuration
Index	0x3142
Subindex	0x01

Data type	UNSIGNED8
Access type	RW
Default value	16
Value range	Digital Inputs - Configuration
PDO mapping	NO
Persistent	YES

Value	Functionality	Description
255	None	No functionality assigned
254...38	Reserved	–
37	PWM current set value offset [a][c][e]	Set current offset over PWM input signal. Scaling Object Digital input PWM current set value offset scaling
36	PWM current set value [a][c][e]	Set current over PWM input signal. Scaling Object Digital input PWM current set value scaling
35...34	Reserved	–
33	PWM velocity set value offset [a][b][e]	Set velocity offset over PWM input signal. Scaling Object Digital input PWM velocity set value offset scaling
32	PWM velocity set value [a][b][e]	Set velocity over PWM input signal. Scaling Object Digital input PWM velocity set value scaling
31...30	Reserved	–
29	Direction [b][c][d]	Switch direction
28	Quick stop	Stop movement and switch to «Quick stop active» state (see Device control)
27	Drive enable	Enable / disable the drive or clear errors in "Fault" state (see Device control)
26...24	Reserved	–
23	General purpose H	State can be read
22	General purpose G	State can be read
21	General purpose F	State can be read
20	General purpose E	State can be read
19	General purpose D	State can be read
18	General purpose C	State can be read
17	General purpose B	State can be read
16	General purpose A	State can be read
15	Current set value switch 1 [c][e]	Select current value (see Current set value switch parameter)
14	Current set value switch 0 [c][e]	Select current value (see Current set value switch parameter)
13	Velocity set value switch 1 [b][e]	Select velocity value (see Velocity set value switch parameter)
12	Velocity set value switch 0 [b][e]	Select velocity value (see Velocity set value switch parameter)
11...2	Reserved	–
1	Positive limit switch	Generates Positive limit switch error
0	Negative limit switch	Generates Negative limit switch error

[a] Supported on [Digital input 1 configuration](#) and [Digital input 2 configuration](#) only.

[b] In [I/O Velocity Mode \(IOVM\)](#) only.

[c] In [I/O Current Mode \(IOCM\)](#) only.

Value	Functionality	Description
[d]	A positive set value is inverted if direction is inactive. A positive set value is not modified if direction is active. A negative set value is limited to zero. For details, see diagrams I/O Velocity Mode - overview and I/O Current Mode - Overview .	
[e]	For every target to control, only one input functionality (analog or digital) can be active.	

Table 59. Digital Inputs - Configuration

6.2.27.2. Digital input 2 configuration

Name	Digital input 2 configuration
Index	0x3142
Subindex	0x02
Data type	UNSIGNED8
Access type	RW
Default value	17
Value range	Digital Inputs - Configuration
PDO mapping	NO
Persistent	YES

6.2.27.3. Digital input 3 configuration

Name	Digital input 3 configuration
Index	0x3142
Subindex	0x03
Data type	UNSIGNED8
Access type	RW
Default value	18
Value range	Digital Inputs - Configuration
PDO mapping	NO
Persistent	YES

6.2.27.4. Digital input 4 configuration

Name	Digital input 4 configuration
Index	0x3142
Subindex	0x04
Data type	UNSIGNED8
Access type	RW
Default value	19
Value range	Digital Inputs - Configuration
PDO mapping	NO
Persistent	YES

6.2.27.5. High-speed digital input 1 configuration

Name	High-speed digital input 1 configuration
------	--

Index	0x3142
Subindex	0x05
Data type	UNSIGNED8
Access type	RW
Default value	255
Value range	Digital Inputs - Configuration
PDO mapping	NO
Persistent	YES

6.2.27.6. High-speed digital input 2 configuration

Name	High-speed digital input 2 configuration
Index	0x3142
Subindex	0x06
Data type	UNSIGNED8
Access type	RW
Default value	255
Value range	Digital Inputs - Configuration
PDO mapping	NO
Persistent	YES

6.2.27.7. High-speed digital input 3 configuration

Name	High-speed digital input 3 configuration
Index	0x3142
Subindex	0x07
Data type	UNSIGNED8
Access type	RW
Default value	255
Value range	Digital Inputs - Configuration
PDO mapping	NO
Persistent	YES

6.2.27.8. High-speed digital input 4 configuration

Name	High-speed digital input 4 configuration
Index	0x3142
Subindex	0x08
Data type	UNSIGNED8
Access type	RW
Default value	255
Value range	Digital Inputs - Configuration
PDO mapping	NO
Persistent	YES

6.2.28. Digital inputs functionality

Displays the state of the CiA digital input functionalities and manufacturer-specific digital input functionalities (after polarity correction by [Digital inputs polarity](#)). A bit is read as "1" if the signal at the corresponding pin is high. For values of CiA digital input functionalities only, see [Digital inputs](#).

Related objects: [Digital input properties](#) / [Configuration of digital inputs](#), [Digital inputs](#)

Name	Digital inputs functionality
Index	0x3143
Subindex	0x00
Data type	UNSIGNED32
Access type	RO
Default value	-
Value range	Digital Inputs
PDO mapping	TXPDO
Persistent	NO

Bit	Functionality	Description
31..30	Reserved	-
29	Direction	Switch direction
28	Quick stop	Stop movement and switch to «Quick stop active» state (see Device control)
27	Drive enable	Enable / disable the drive or clear errors in "Fault" state (see Device control)
26..24	Reserved	-
23	General purpose H	State can be read
22	General purpose G	State can be read
21	General purpose F	State can be read
20	General purpose E	State can be read
19	General purpose D	State can be read
18	General purpose C	State can be read
17	General purpose B	State can be read
16	General purpose A	State can be read
15	Current set value switch 1	Select current value (see Current set value switch parameter)
14	Current set value switch 0	Select current value (see Current set value switch parameter)
13	Velocity set value switch 1	Select velocity value (see Velocity set value switch parameter)
12	Velocity set value switch 0	Select velocity value (see Velocity set value switch parameter)
11..2	Reserved	-
1	Positive limit switch	Generates Positive limit switch error
0	Negative limit switch	Generates Negative limit switch error

Table 60. Digital Inputs

6.2.29. Velocity set value switch parameter

Preset velocity values to be selected by digital inputs. Values given in [\[velocity units\]](#). Write access is only permitted in device state «Power Disable» (see [Device control](#)). The functionality is supported in [I/O Velocity Mode \(IOVM\)](#) when at least one corresponding functionality («velocity set value switch», see [Digital Inputs](#)) is mapped to a digital input pin in [Configuration of digital inputs](#). The selected velocity is then written to [Target](#)

velocity.

Unmapping both «velocity set value switch» functionalities does not restore a previously written **Target velocity** value.

Related objects: [Configuration of digital inputs](#), [Target velocity](#), [SI unit velocity](#)

Name	Velocity set value switch parameter
Index	0x3146
Object code	ARRAY
Highest subindex supported	4

«Velocity set value switch 1» input state	«Velocity set value switch 0» input state	Selected Velocity
0 (or unmapped)	0 (or unmapped)	Set velocity value 0 (if at least one «velocity set value switch» functionality is mapped to a pin)
0 (or unmapped)	1	Set velocity value 1
1	0 (or unmapped)	Set velocity value 2
1	1	Set velocity value 3

Table 61. Velocity set value switch

6.2.29.1. Set velocity value 0

Name	Set velocity value 0	
Index	0x3146	
Subindex	0x01	
Data type	INTEGER32	
Access type	RW	
Default value	0	
Value range	-120'000 rpm	+120'000 rpm
PDO mapping	NO	
Persistent	YES	

6.2.29.2. Set velocity value 1

Name	Set velocity value 1	
Index	0x3146	
Subindex	0x02	
Data type	INTEGER32	
Access type	RW	
Default value	0	
Value range	-120'000 rpm	+120'000 rpm
PDO mapping	NO	
Persistent	YES	

6.2.29.3. Set velocity value 2

Name	Set velocity value 2	
Index	0x3146	

Subindex	0x03	
Data type	INTEGER32	
Access type	RW	
Default value	0	
Value range	-120'000 rpm	+120'000 rpm
PDO mapping	NO	
Persistent	YES	

6.2.29.4. Set velocity value 3

Name	Set velocity value 3	
Index	0x3146	
Subindex	0x04	
Data type	INTEGER32	
Access type	RW	
Default value	0	
Value range	-120'000 rpm	+120'000 rpm
PDO mapping	NO	
Persistent	YES	

6.2.30. Current set value switch parameter

Preset current values to be selected by digital inputs. Values given in [mA]. Write access is only permitted in device state «Power Disable» (see [Device control](#)). The functionality is supported in [I/O Current Mode \(IOCM\)](#) when at least one corresponding functionality («current set value switch», see [Digital Inputs](#)) is mapped to a digital input pin in [Configuration of digital inputs](#). The selected current is then written to [Target current](#). Unmapping both «current set value switch» functionalities does not restore a previously written [Target current](#) value.

Related objects: [Configuration of digital inputs](#), [Target current](#)

Name	Current set value switch parameter	
Index	0x3147	
Object code	ARRAY	
Highest subindex supported	4	

«Current set value switch 1» input state	«Current set value switch 0» input state	Selected Velocity
0 (or unmapped)	0 (or unmapped)	Set current value 0 (if at least one «current set value switch» functionality is mapped to a pin)
0 (or unmapped)	1	Set current value 1
1	0 (or unmapped)	Set current value 2
1	1	Set current value 3

Table 62. Current set value switch

6.2.30.1. Set current value 0

Name	Set current value 0	
Index	0x3147	

Subindex	0x01	
Data type	INTEGER32	
Access type	RW	
Default value	0	
Value range	- Max Output current limit	+ Max Output current limit
PDO mapping	NO	
Persistent	YES	

6.2.30.2. Set current value 1

Name	Set current value 1	
Index	0x3147	
Subindex	0x02	
Data type	INTEGER32	
Access type	RW	
Default value	0	
Value range	- Max Output current limit	+ Max Output current limit
PDO mapping	NO	
Persistent	YES	

6.2.30.3. Set current value 2

Name	Set current value 2	
Index	0x3147	
Subindex	0x03	
Data type	INTEGER32	
Access type	RW	
Default value	0	
Value range	- Max Output current limit	+ Max Output current limit
PDO mapping	NO	
Persistent	YES	

6.2.30.4. Set current value 3

Name	Set current value 3	
Index	0x3147	
Subindex	0x04	
Data type	INTEGER32	
Access type	RW	
Default value	0	
Value range	- Max Output current limit	+ Max Output current limit
PDO mapping	NO	
Persistent	YES	

6.2.31. Digital input PWM frequencies

Displays the actual PWM frequencies and represents the PWM signal measured at the configured digital input. Values given in [0.1 Hz].

Note:



PWM input supports a frequency range of 50...10'000 Hz. Outside this range a warning ([Digital input 1 PWM frequency warning](#) or [Digital input 2 PWM frequency warning](#)) is active and the frequency is limited to the specified range. If the PWM frequency deviates too much from the specified range and becomes unreadable, [Digital input 1 PWM error](#) or [Digital input 2 PWM error](#) is triggered and this objects displays the value of 0 Hz.

Name	Digital input PWM frequencies
Index	0x314B
Object code	ARRAY
Highest subindex supported	2

6.2.31.1. Digital input 1 PWM frequency

Name	Digital input 1 PWM frequency
Index	0x314B
Subindex	0x01
Data type	UNSIGNED32
Access type	RO
Default value	-
Value range	-
PDO mapping	TXPDO
Persistent	NO

6.2.31.2. Digital input 2 PWM frequency

Name	Digital input 2 PWM frequency
Index	0x314B
Subindex	0x02
Data type	UNSIGNED32
Access type	RO
Default value	-
Value range	-
PDO mapping	TXPDO
Persistent	NO

6.2.32. Digital input PWM duty cycles

Displays the actual PWM duty cycles and represents the PWM signal measured at the configured digital input. Given in [0.1%].

Note:



PWM input is specified to support duty cycles in the range 10...90 %. Duty cycles outside this range are limited and the device will show a [Digital input 1 PWM duty cycle warning](#) or [Digital input 2 PWM duty cycle warning](#), but there is a slightly threshold until the warning appears. The warning disappears, if the detected duty cycle enters the valid range again. While the warning is active, the duty cycle is restricted to the range 10...90 %. When reaching a pulse width (positive or negative) smaller than 5 μ s, error [Digital input 1 PWM error](#) or [Digital input 2 PWM error](#) is triggered.

Name	Digital input PWM duty cycles
Index	0x314C
Object code	ARRAY
Highest subindex supported	2

6.2.32.1. Digital input 1 PWM duty cycle

Name	Digital input 1 PWM duty cycle
Index	0x314C
Subindex	0x01
Data type	UNSIGNED16
Access type	RO
Default value	-
Value range	-
PDO mapping	TXPDO
Persistent	NO

6.2.32.2. Digital input 2 PWM duty cycle

Name	Digital input 2 PWM duty cycle
Index	0x314C
Subindex	0x02
Data type	UNSIGNED16
Access type	RO
Default value	-
Value range	-
PDO mapping	TXPDO
Persistent	NO

6.2.33. Digital outputs properties

Related objects: [Configuration of digital outputs](#), [Digital outputs](#), [Digital outputs functionality](#).

Name	Digital outputs properties
Index	0x3150
Object code	RECORD
Highest subindex supported	2

6.2.33.1. Digital outputs logic state

Displays the digital output logic state (after polarity correction). A bit is read as “1” if the signal at the

corresponding pin is high. The state is set to zero if a frequency output functionality ([Configuration of digital outputs](#)) is configured on the corresponding output.

Name	Digital outputs logic state	
Index	0x3150	
Subindex	0x01	
Data type	UNSIGNED16	
Access type	RO	
Default value	-	
Value range	-	-
PDO mapping	TXPDO	
Persistent	NO	

Bit	Description
2	High-speed digital output 1
1	Digital output 2
0	Digital output 1

Table 63. Digital output bits

6.2.33.2. Digital outputs polarity

Used to set the polarity of the digital outputs. If a bit is set to “1”, the associated output will be inverted; thus, “1” in [Digital outputs functionality](#) (and [Digital outputs](#) if applicable) will set the output pin low.

Polarity only applies to outputs with configured functionality ([Configuration of digital outputs](#)); not configured pins will remain zero. The polarity setting has no effect if a frequency output functionality ([Configuration of digital outputs](#)) is configured on the corresponding output.

For bit description, see [Digital output bits](#).

Name	Digital outputs polarity	
Index	0x3150	
Subindex	0x02	
Data type	UNSIGNED16	
Access type	RW	
Default value	0x0000	
Value range	-	-
PDO mapping	NO	
Persistent	YES	

6.2.34. Configuration of digital outputs

Configures the functionality that will be assigned to the digital outputs. A functionality can only be mapped to an output once, except for the frequency outputs, where only one functionality can be used simultaneously.

If sensor 2 is configured ([Sensors configuration](#)), the high-speed digital output 1 will be disabled. This configuration cannot be overridden as long as sensor 2 is configured.

Related objects: [Digital outputs properties](#), [Digital outputs functionality](#), [Digital outputs](#)

Name	Configuration of digital outputs
------	----------------------------------

Index	0x3151
Object code	ARRAY
Highest subindex supported	3

6.2.34.1. Digital output 1 configuration

Name	Digital output 1 configuration
Index	0x3151
Subindex	0x01
Data type	UNSIGNED8
Access type	RW
Default value	Digital outputs - Default values
Value range	Digital outputs - Configuration
PDO mapping	NO
Persistent	YES

Digital Output	Default Value
DigOut1	16: General purpose A
DigOut2	17: General purpose B
HsDigOut1	255: None

Table 64. Digital outputs - Default values

Value	Functionality	Description
255	None	No functionality assigned
254..34	Reserved	-
33	Hall sensor rotation frequency	Corresponding output (DigOut1 or DigOut2) is configured as hall sensor rotation frequency output. Functionality can only be mapped if a hall sensor is present (Sensors configuration) and cannot be mapped to an HsDigOut.
32	Hall sensor commutation frequency	Corresponding output (DigOut1 or DigOut2) is configured as hall sensor commutation frequency output. Functionality can only be mapped if a hall sensor is present (Sensors configuration) and cannot be mapped to an HsDigOut.
31..27	Reserved	-
26	Limitation	Active if an internal limit (Statusword Bit 11) is active
25	Ready/Fault	Inactive on device fault or fault reaction state, otherwise active
24..19	Reserved	-
18	General purpose C	State can be read/written by the host
17	General purpose B	State can be read/written by the host
16	General purpose A	State can be read/written by the host
15...0	Reserved	-

Table 65. Digital outputs - Configuration

6.2.34.2. Digital output 2 configuration

Name	Digital output 2 configuration
Index	0x3151

Subindex	0x02
Data type	UNSIGNED8
Access type	RW
Default value	Digital outputs - Default values
Value range	Digital outputs - Configuration
PDO mapping	NO
Persistent	YES

6.2.34.3. High-speed digital output 1 configuration

Name	High-speed digital output 1 configuration
Index	0x3151
Subindex	0x03
Data type	UNSIGNED8
Access type	RW
Default value	Digital outputs - Default values
Value range	Digital outputs - Configuration
PDO mapping	NO
Persistent	YES

6.2.35. Digital outputs functionality

Displays the state of the digital output functionalities (before polarity correction by [Digital outputs polarity](#)). If a bit is set to “1” and the polarity bit is set to “0”, the signal at the corresponding pin is high.

This object is read/write, however, bits 24...31 are ignored upon writing.

This value is a superset of [Digital outputs](#)

Related objects: [Digital outputs properties](#), [Configuration of digital outputs](#), [Digital outputs](#).

Name	Digital outputs functionality	
Index	0x3152	
Subindex	0x00	
Data type	UNSIGNED32	
Access type	RW	
Default value	0x0	
Value range	-	-
PDO mapping	RXPDO	
Persistent	NO	

Bit	Functionality	Description
31..27	Reserved	-
26	Limitation	Active if an internal limit (Statusword Bit 11) is active
25	Ready/Fault	Inactive on device fault or fault reaction state, otherwise active
24..19	Reserved	-
18	General purpose C	State can be read/written by the host
17	General purpose B	State can be read/written by the host

Bit	Functionality	Description
16	General purpose A	State can be read/written by the host
15...0	Reserved	-

Table 66. Digital outputs - values

6.2.36. Analog input properties

Name	Analog input properties
Index	0x3160
Object code	ARRAY
Highest subindex supported	2

6.2.36.1. Analog input 1 voltage

Represents the voltage measured at Analog Input 1. The value is given in [mV].

Name	Analog input 1 voltage	
Index	0x3160	
Subindex	0x01	
Data type	INTEGER16	
Access type	RO	
Default value	-	
Value range	-	-
PDO mapping	TXPDO	
Persistent	NO	

6.2.36.2. Analog input 2 voltage

Represents the voltage measured at Analog Input 2. The value is given in [mV].

Name	Analog input 2 voltage	
Index	0x3160	
Subindex	0x02	
Data type	INTEGER16	
Access type	RO	
Default value	-	
Value range	-	-
PDO mapping	TXPDO	
Persistent	NO	

6.2.37. Configuration of analog inputs

Configures the functionality that will be assigned to analog inputs.

Related object: [Analog input properties](#)

Name	Configuration of analog inputs
Index	0x3161

Object code	ARRAY
Highest subindex supported	2

6.2.37.1. Analog input 1 configuration

Maps functions to analog inputs. Each function can only be mapped once, and each analog input can only hold one function.

Name	Analog input 1 configuration
Index	0x3161
Subindex	0x01
Data type	UNSIGNED8
Access type	RW
Default value	Analog Inputs - Default Values
Value range	Analog Inputs - Configuration
PDO mapping	NO
Persistent	YES

Analog Input	Default Value
AnIn1	0 : General Purpose A
AnIn2	1 : General Purpose B

Table 67. Analog Inputs - Default Values

Value	Functionality	Description
255	None	No functionality assigned
254...12	Reserved	–
11	Velocity set value offset [a]	Set Velocity offset over analog input signal. Scaling Object Analog input velocity set value offset scaling
10	Current set value offset [a]	Set Current offset over analog input signal. Scaling Object Analog input current set value offset scaling
9	Velocity set value [a]	Set Target velocity over analog input signal. Scaling Object Analog input velocity set value scaling
8	Current set value [a]	Set Target current over analog input signal. Scaling Object Analog input current set value scaling
7...2	Reserved	–
1	General purpose B	Value can be read
0	General purpose A	Value can be read

[a] For every target to control, only one input functionality (analog or digital) can be active.

Table 68. Analog Inputs - Configuration

6.2.37.2. Analog input 2 configuration

Name	Analog input 2 configuration
Index	0x3161
Subindex	0x02
Data type	UNSIGNED8
Access type	RW

Default value	Analog Inputs - Default Values
Value range	Analog Inputs - Configuration
PDO mapping	NO
Persistent	YES

6.2.38. Analog input general purpose

Displays the actual value measured at the analog inputs. The value is only displayed if the analog input is configured as general purpose. The value is given in [mV].

Related object: [Analog input properties](#)

Name	Analog input general purpose
Index	0x3162
Object code	ARRAY
Highest subindex supported	2

6.2.38.1. Analog input general purpose A

Name	Analog input general purpose A	
Index	0x3162	
Subindex	0x01	
Data type	INTEGER16	
Access type	RO	
Default value	-	
Value range	-	-
PDO mapping	TXPDO	
Persistent	NO	

6.2.38.2. Analog input general purpose B

Name	Analog input general purpose B	
Index	0x3162	
Subindex	0x02	
Data type	INTEGER16	
Access type	RO	
Default value	-	
Value range	-	-
PDO mapping	TXPDO	
Persistent	NO	

6.2.39. Analog input adjustment

Adjust individual analog input voltages with a gain factor and offset value. Offset is applied before gain.

Name	Analog input adjustment
Index	0x3163
Object code	RECORD

Highest subindex supported	4
----------------------------	---

6.2.39.1. Analog input 1 adjustment offset

Represents the adjustment offset voltage of analog input 1. The value is given in [mV].

Name	Analog input 1 adjustment offset	
Index	0x3163	
Subindex	0x01	
Data type	INTEGER32	
Access type	RW	
Default value	0	
Value range	-1'000	1'000
PDO mapping	NO	
Persistent	YES	

6.2.39.2. Analog input 1 adjustment gain factor

Represents the adjustment gain factor of analog input 1. The value is given in [1/10'000].

Name	Analog input 1 adjustment gain factor	
Index	0x3163	
Subindex	0x02	
Data type	UNSIGNED16	
Access type	RW	
Default value	10'000	
Value range	5'000	20'000
PDO mapping	NO	
Persistent	YES	

6.2.39.3. Analog input 2 adjustment offset

Represents the adjustment offset voltage of analog input 2. The value is given in [mV].

Name	Analog input 2 adjustment offset	
Index	0x3163	
Subindex	0x03	
Data type	INTEGER32	
Access type	RW	
Default value	0	
Value range	-1'000	1'000
PDO mapping	NO	
Persistent	YES	

6.2.39.4. Analog input 2 adjustment gain factor

Represents the adjustment gain factor of analog input 2. The value is given in [1/10'000].

Name	Analog input 2 adjustment gain factor	
Index	0x3163	
Subindex	0x04	
Data type	UNSIGNED16	
Access type	RW	
Default value	10'000	
Value range	5'000	20'000
PDO mapping	NO	
Persistent	YES	

6.2.40. Analog input raw values

Name	Analog input raw values	
Index	0x3164	
Object code	ARRAY	
Highest subindex supported	2	

6.2.40.1. Analog input 1 raw value

Represents the measured Analog Input 1 as raw value [ADC counts].

Name	Analog input 1 raw value	
Index	0x3164	
Subindex	0x01	
Data type	UNSIGNED16	
Access type	RO	
Default value	-	
Value range	-	-
PDO mapping	TXPDO	
Persistent	NO	

6.2.40.2. Analog input 2 raw value

Represents the measured Analog Input 2 as raw value [ADC counts].

Name	Analog input 2 raw value	
Index	0x3164	
Subindex	0x02	
Data type	UNSIGNED16	
Access type	RO	
Default value	-	
Value range	-	-
PDO mapping	TXPDO	
Persistent	NO	

6.2.41. Analog output properties

Represents the voltage output at analog outputs. The value is given in [mV].

Name	Analog output properties
Index	0x3170
Object code	ARRAY
Highest subindex supported	2

6.2.41.1. Analog output 1 voltage

Name	Analog output 1 voltage	
Index	0x3170	
Subindex	0x01	
Data type	INTEGER16	
Access type	RO	
Default value	-	
Value range	-	-
PDO mapping	TXPDO	
Persistent	NO	

6.2.41.2. Analog output 2 voltage

Name	Analog output 2 voltage	
Index	0x3170	
Subindex	0x02	
Data type	INTEGER16	
Access type	RO	
Default value	-	
Value range	-	-
PDO mapping	TXPDO	
Persistent	NO	

6.2.42. Configuration of analog outputs

Configures the functionality that will be assigned to analog outputs.

Name	Configuration of analog outputs
Index	0x3171
Object code	ARRAY
Highest subindex supported	2

Analog Output	Default value
AnalogOut1	0: General Purpose A
AnalogOut2	1: General Purpose B

Table 69. Analog outputs - Default values

Value	Functionality	Description
255	None	No functionality assigned
254..14	Reserved	-
13	Temperature power stage	Monitor temperature values as analog output voltage. Scaling object Analog output temperature scaling
12	Temperature logic section	
11	Current actual value averaged	Monitor current values as analog output voltage. Scaling object Analog output current scaling
10	Current actual value	
9	Velocity actual value averaged	Monitor velocity values as analog output voltage. Scaling object Analog output velocity scaling
8	Velocity actual value	
7...2	Reserved	-
1	General purpose B	Value can be read/written by the host
0	General purpose A	Value can be read/written by the host

Table 70. Analog outputs - Configuration

6.2.42.1. Analog output 1 configuration

Name	Analog output 1 configuration
Index	0x3171
Subindex	0x01
Data type	UNSIGNED8
Access type	RW
Default value	Analog outputs - Default values
Value range	Analog outputs - Configuration
PDO mapping	NO
Persistent	YES

6.2.42.2. Analog output 2 configuration

Name	Analog output 2 configuration
Index	0x3171
Subindex	0x02
Data type	UNSIGNED8
Access type	RW
Default value	Analog outputs - Default values
Value range	Analog outputs - Configuration
PDO mapping	NO
Persistent	YES

6.2.43. Analog output general purpose

Used to set the actual voltage on the analog outputs. Writing to this object only has an effect if the analog output is configured as general purpose. The value is given in [mV].

Related object: [Analog output properties](#)

Name	Analog output general purpose
Index	0x3172

Object code	ARRAY
Highest subindex supported	2

6.2.43.1. Analog output general purpose A

Name	Analog output general purpose A
Index	0x3172
Subindex	0x01
Data type	INTEGER16
Access type	RW
Default value	0
Value range	Analog Out - value range
PDO mapping	RXPDO
Persistent	YES

Hardware	Lower Limit	Upper Limit
ESCON2 Module 60/30 ESCON2 Compact 60/30	-4'000mV	4'000mV
ESCON2 Micro 60/5	-4'000mV	4'000mV
ESCON2 Nano 24/2	0mV	3'300mV

Table 71. Analog Out - value range

6.2.43.2. Analog output general purpose B

Name	Analog output general purpose B
Index	0x3172
Subindex	0x02
Data type	INTEGER16
Access type	RW
Default value	0
Value range	Analog Out - value range
PDO mapping	RXPDO
Persistent	YES

6.2.44. Digital input PWM velocity set value scaling

A set value function for the PWM input. Write access is only permitted in device state «Power Disable» (see [Device control](#)). It configures the velocity set value, which is set by a PWM input value. Invalid scaling settings (first and second duty cycle identical) results in the first velocity being used ([Velocity set value first velocity](#)). The functionality is supported in [I/O Velocity Mode \(IOVM\)](#).

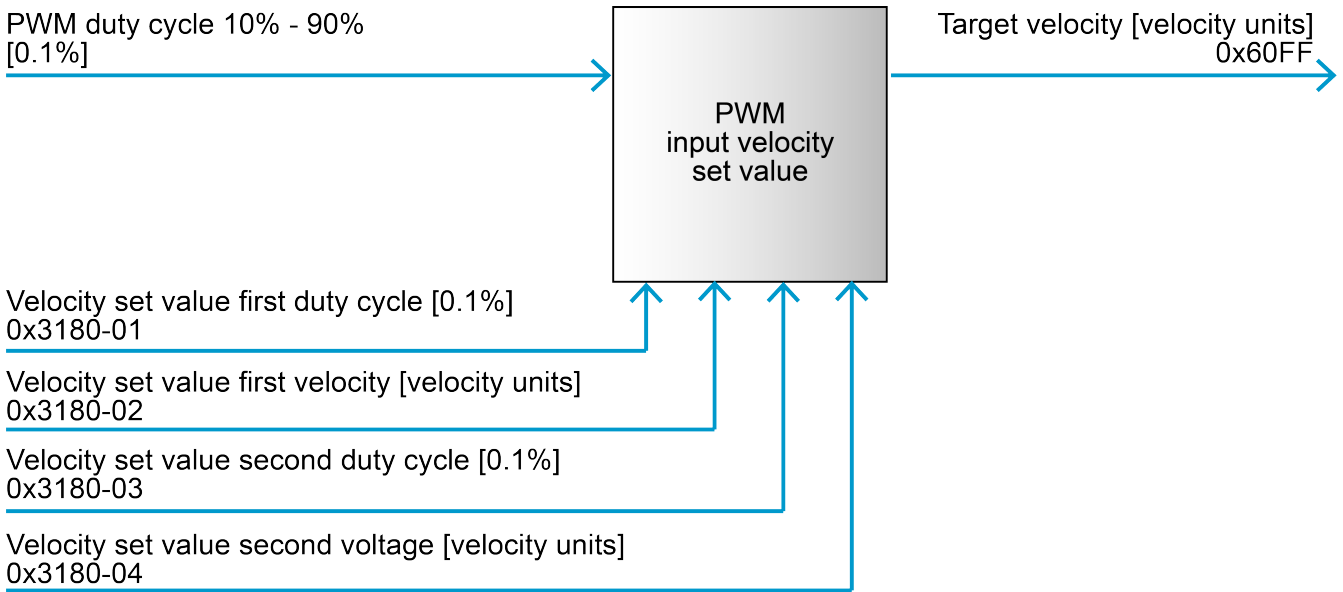

Figure 15. Digital input PWM velocity set value scaling – Set value function

Name	Digital input PWM velocity set value scaling
Index	0x3180
Object code	RECORD
Highest subindex supported	4

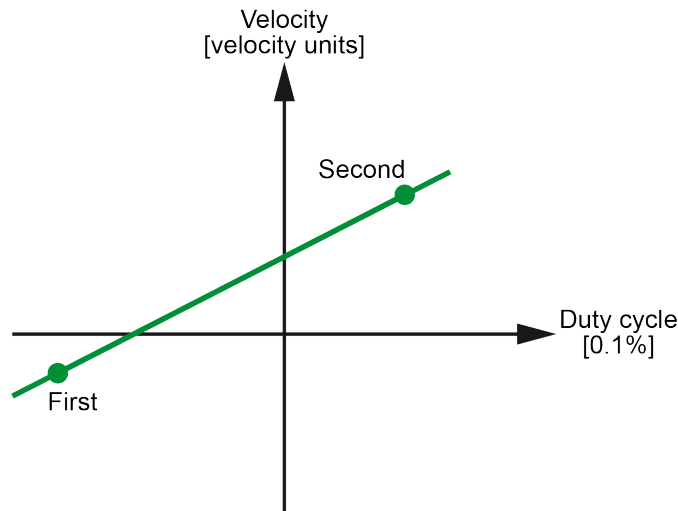

Figure 16. Digital PWM velocity set value scaling – Set value

6.2.44.1. Velocity set value first duty cycle

Represents the set duty cycle for the first slope point. The value is given as [0.1%].

Name	Velocity set value first duty cycle
Index	0x3180
Subindex	0x01
Data type	INTEGER32
Access type	RW
Default value	100

Value range	100	900
PDO mapping	NO	
Persistent	YES	

6.2.44.2. Velocity set value first velocity

Represents the set velocity for the first slope point. The value is given in [\[velocity units\]](#).

Name	Velocity set value first velocity	
Index	0x3180	
Subindex	0x02	
Data type	INTEGER32	
Access type	RW	
Default value	0	
Value range	- 120'000 rpm	+ 120'000 rpm
PDO mapping	NO	
Persistent	YES	

6.2.44.3. Velocity set value second duty cycle

Represents the set duty cycle for the second slope point. The value is given as [0.1%].

Name	Velocity set value second duty cycle	
Index	0x3180	
Subindex	0x03	
Data type	INTEGER32	
Access type	RW	
Default value	900	
Value range	100	900
PDO mapping	NO	
Persistent	YES	

6.2.44.4. Velocity set value second velocity

Represents the set velocity for the second slope point. The value is given in [\[velocity units\]](#).

Name	Velocity set value second velocity	
Index	0x3180	
Subindex	0x04	
Data type	INTEGER32	
Access type	RW	
Default value	0	
Value range	- 120'000 rpm	+ 120'000 rpm
PDO mapping	NO	
Persistent	YES	

6.2.45. Digital input PWM velocity set value offset scaling

A set value function for the PWM input. Write access is only permitted in device state «Power Disable» (see [Device control](#)). It configures the velocity set value offset which is set by a PWM input value. Invalid scaling settings (first and second duty cycle identical) results in the first velocity set value offset being used ([Velocity set value offset first velocity](#)). The functionality is supported in [I/O Velocity Mode \(IOVM\)](#).

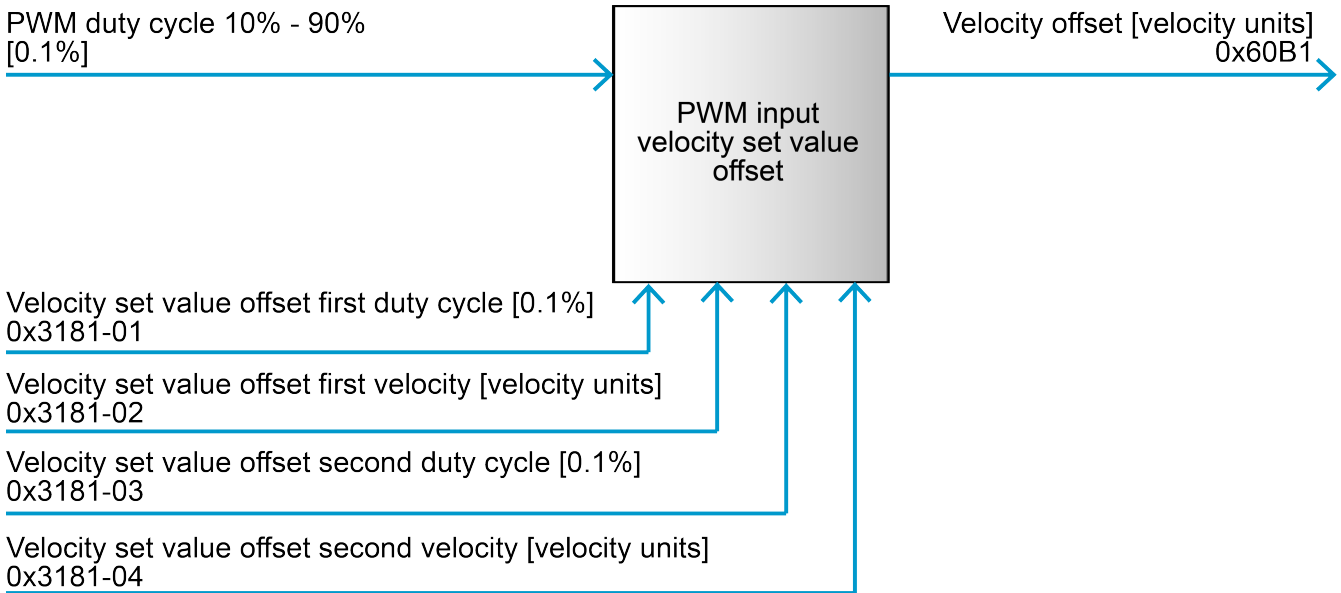

Figure 17. Digital input PWM velocity set value offset scaling – Set value function

Name	Digital input PWM velocity set value offset scaling
Index	0x3181
Object code	RECORD
Highest subindex supported	4

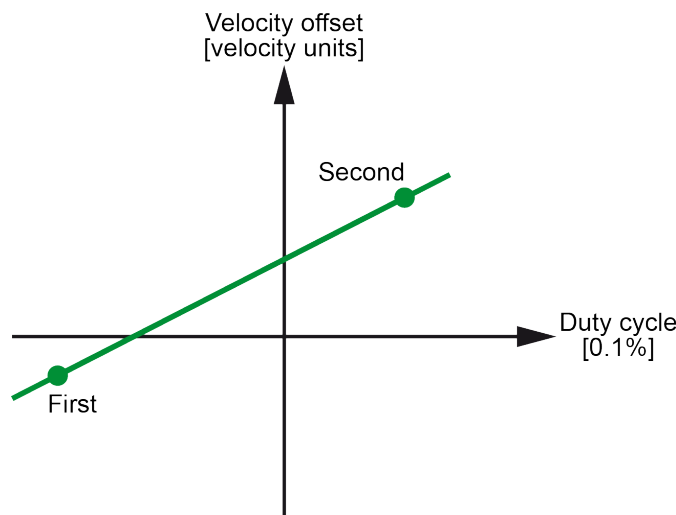

Figure 18. Digital input PWM velocity set value offset scaling – Set value

6.2.45.1. Velocity set value offset first duty cycle

Represents the set duty cycle for the first slope point. The value is given in [0.1 %].

Name	Velocity set value offset first duty cycle
------	--

Index	0x3181	
Subindex	0x01	
Data type	INTEGER32	
Access type	RW	
Default value	100	
Value range	100	900
PDO mapping	NO	
Persistent	YES	

6.2.45.2. Velocity set value offset first velocity

Represents the set velocity for the first slope point. The value is given in [velocity units].

Name	Velocity set value offset first velocity	
Index	0x3181	
Subindex	0x02	
Data type	INTEGER32	
Access type	RW	
Default value	0	
Value range	- 120'000 rpm	+ 120'000 rpm
PDO mapping	NO	
Persistent	YES	

6.2.45.3. Velocity set value offset second duty cycle

Represents the set duty cycle for the second slope point. The value is given in [0.1 %].

Name	Velocity set value offset second duty cycle	
Index	0x3181	
Subindex	0x03	
Data type	INTEGER32	
Access type	RW	
Default value	900	
Value range	100	900
PDO mapping	NO	
Persistent	YES	

6.2.45.4. Velocity set value offset second velocity

Represents the set velocity for the second slope point. The value is given in [velocity units].

Name	Velocity set value offset second velocity	
Index	0x3181	
Subindex	0x04	
Data type	INTEGER32	
Access type	RW	

Default value	0	
Value range	- 120'000 rpm	+ 120'000 rpm
PDO mapping	NO	
Persistent	YES	

6.2.46. Digital input PWM current set value scaling

A set value function for the PWM input. Write access is only permitted in device state «Power Disable» (see [Device control](#)). It configures the current set value, which is set by a PWM input value. Invalid scaling settings (first and second duty cycle identical) results in the first current being used ([Current set value first current](#)). The functionality is supported in [I/O Current Mode \(IOCM\)](#).

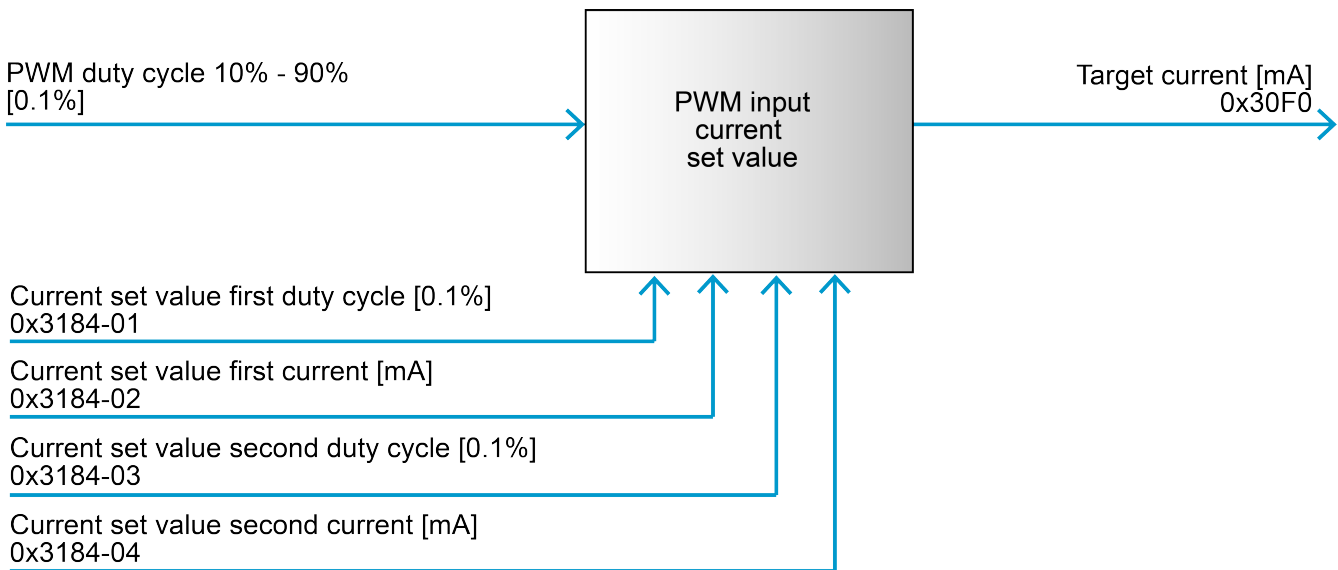

Figure 19. Digital input PWM current set value scaling – Set value function

Name	Digital input PWM current set value scaling
Index	0x3184
Object code	RECORD
Highest subindex supported	4

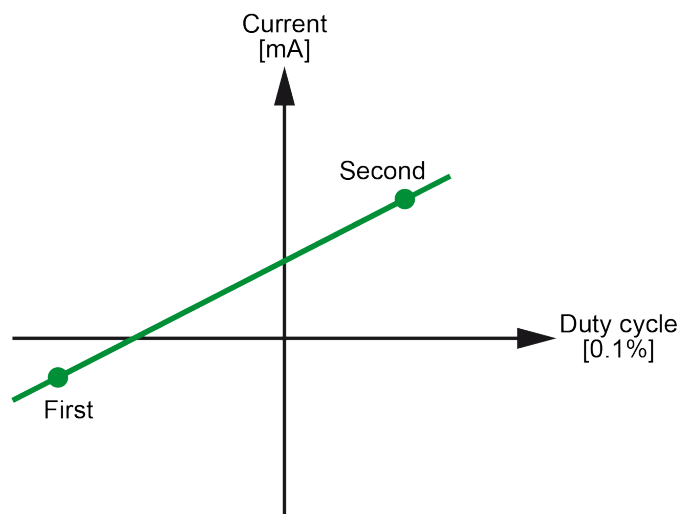

Figure 20. Digital input PWM current set value scaling – Set value

6.2.46.1. Current set value first duty cycle

Represents the set duty cycle for the first slope point. The value is given as [0.1%].

Name	Current set value first duty cycle	
Index	0x3184	
Subindex	0x01	
Data type	INTEGER32	
Access type	RW	
Default value	100	
Value range	100	900
PDO mapping	NO	
Persistent	YES	

6.2.46.2. Current set value first current

Represents the output current for the first slope point. The value is given in [mA].

Name	Current set value first current	
Index	0x3184	
Subindex	0x02	
Data type	INTEGER32	
Access type	RW	
Default value	0	
Value range	- Max Output current limit	+ Max Output current limit
PDO mapping	NO	
Persistent	YES	

6.2.46.3. Current set value second duty cycle

Represents the set duty cycle for the second slope point. The value is given as [0.1%].

Name	Current set value second duty cycle	
Index	0x3184	
Subindex	0x03	
Data type	INTEGER32	
Access type	RW	
Default value	900	
Value range	100	900
PDO mapping	NO	
Persistent	YES	

6.2.46.4. Current set value second current

Represents the output current for the second slope point. The value is given in [mA].

Name	Current set value second current
------	----------------------------------

Index	0x3184	
Subindex	0x04	
Data type	INTEGER32	
Access type	RW	
Default value	0	
Value range	- Max Output current limit	+ Max Output current limit
PDO mapping	NO	
Persistent	YES	

6.2.47. Digital input PWM current set value offset scaling

A set value function for the PWM input. Write access is only permitted in device state «Power Disable» (see [Device control](#)). It configures the current set value offset which is set by a PWM input value. Invalid scaling settings (first and second duty cycle identical) results in the first current set value offset being used ([Current set value offset first current](#)). The functionality is supported in [I/O Current Mode \(IOCM\)](#).

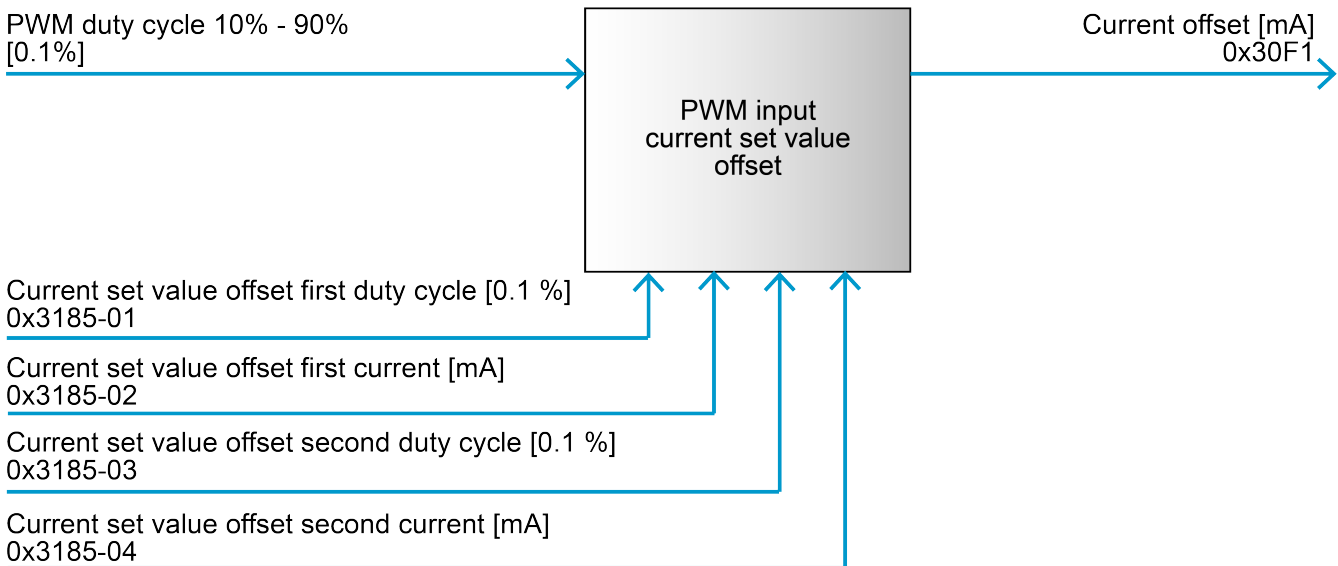

Figure 21. Digital input PWM current set value offset scaling – Set value function

Name	Digital input PWM current set value offset scaling
Index	0x3185
Object code	RECORD
Highest subindex supported	4

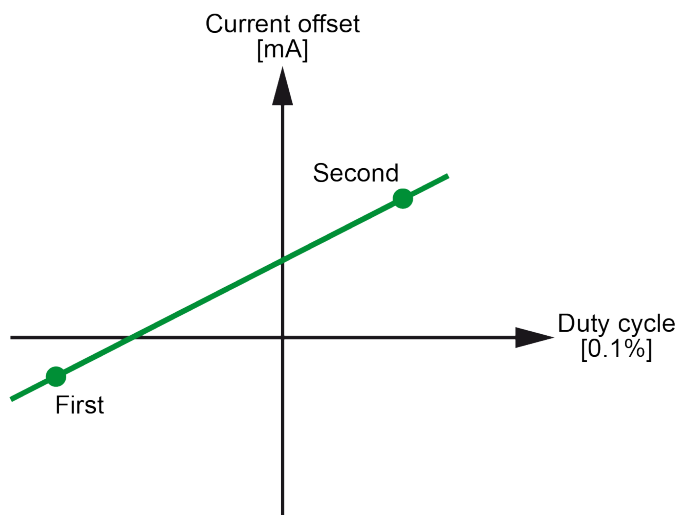

Figure 22. Digital input PWM current set value offset scaling – Set value

6.2.47.1. Current set value offset first duty cycle

Represents the set duty cycle for the first slope point. The value is given in [0.1 %].

Name	Current set value offset first duty cycle	
Index	0x3185	
Subindex	0x01	
Data type	INTEGER32	
Access type	RW	
Default value	100	
Value range	100	900
PDO mapping	NO	
Persistent	YES	

6.2.47.2. Current set value offset first current

Represents the output current for the first slope point. The value is given in [mA].

Name	Current set value offset first current	
Index	0x3185	
Subindex	0x02	
Data type	INTEGER32	
Access type	RW	
Default value	0	
Value range	- Max Output current limit	+ Max Output current limit
PDO mapping	NO	
Persistent	YES	

6.2.47.3. Current set value offset second duty cycle

Represents the set duty cycle for the second slope point. The value is given in [0.1 %].

Name	Current set value offset second duty cycle
------	--

Index	0x3185	
Subindex	0x03	
Data type	INTEGER32	
Access type	RW	
Default value	900	
Value range	100	900
PDO mapping	NO	
Persistent	YES	

6.2.47.4. Current set value offset second current

Represents the output current for the second slope point. The value is given in [mA].

Name	Current set value offset second current	
Index	0x3185	
Subindex	0x04	
Data type	INTEGER32	
Access type	RW	
Default value	0	
Value range	- Max Output current limit	+ Max Output current limit
PDO mapping	NO	
Persistent	YES	

6.2.48. Analog input velocity set value scaling

A set value function for the analog input. Write access is only permitted in device state «Power Disable» (see [Device control](#)). It configures the velocity set value, which is set by an analog input value. Invalid scaling settings (first and second voltage identical) results in the first velocity being used ([Velocity set value first velocity](#)). The functionality is supported in [I/O Velocity Mode \(IOVM\)](#).

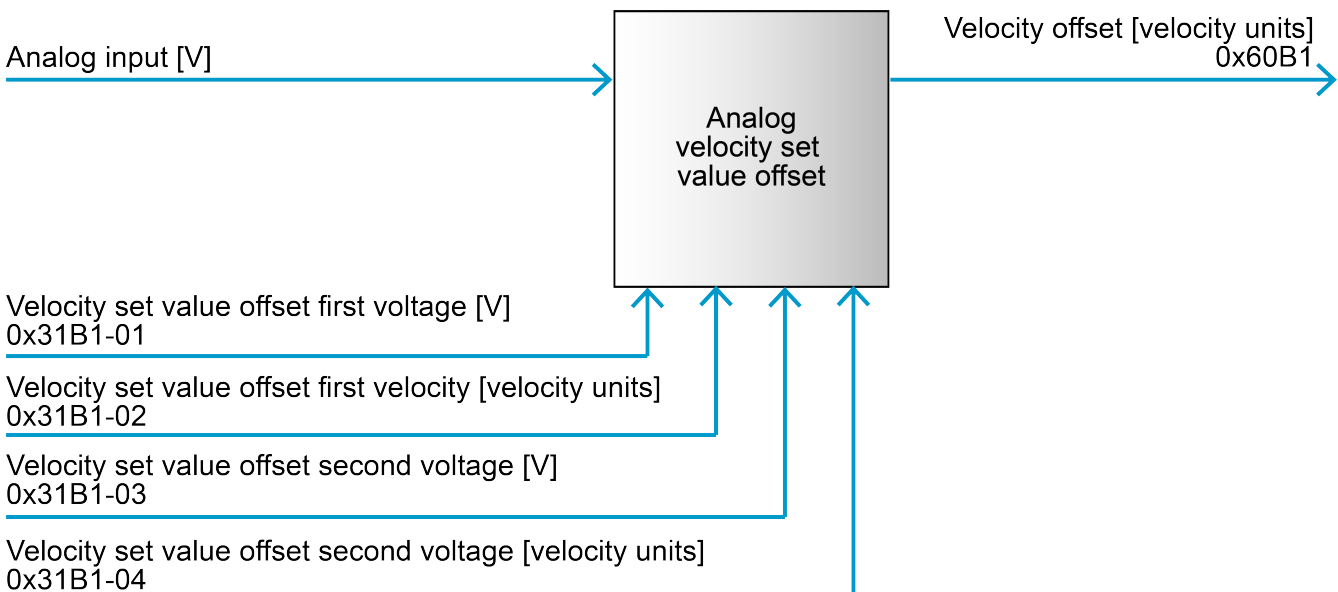

Figure 23. Analog input velocity set value scaling – Set value function

Name	Analog input velocity set value scaling
Index	0x31B0
Object code	RECORD
Highest subindex supported	4

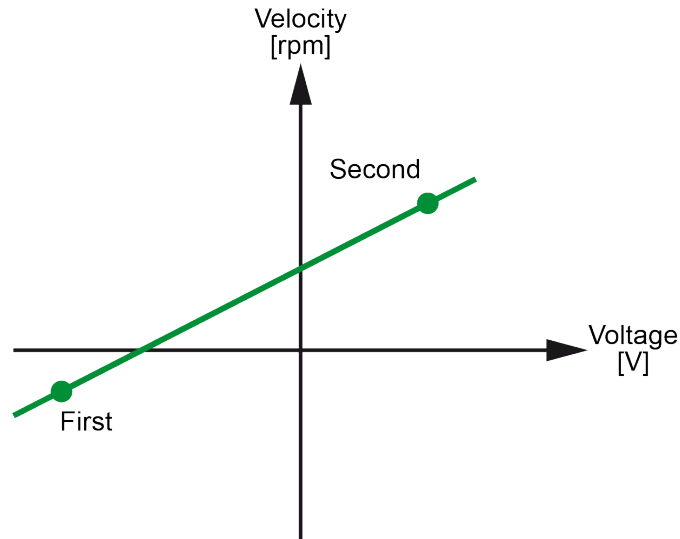

Figure 24. Analog input velocity set value scaling – Set value

6.2.48.1. Velocity set value first voltage

Represents the set voltage for the first slope point. The value is given in [mV].

Name	Velocity set value first voltage
Index	0x31B0
Subindex	0x01
Data type	INTEGER32
Access type	RW
Default value	Analog In - default value first slope point
Value range	Analog In - value range
PDO mapping	NO
Persistent	YES

Hardware	Default
ESCON2 Module 60/30 ESCON2 Compact 60/30	-10'000mV
ESCON2 Micro 60/5	-10'000mV
ESCON2 Nano 24/2	0mV

Table 72. Analog In - default value first slope point

Hardware	Lower Limit	Upper Limit
ESCON2 Module 60/30 ESCON2 Compact 60/30	-10'000mV	10'000mV
ESCON2 Micro 60/5	-10'000mV	10'000mV
ESCON2 Nano 24/2	0mV	5'000mV

Table 73. Analog In - value range

6.2.48.2. Velocity set value first velocity

Represents the set velocity for the first slope point. The value is given in [velocity units].

Name	Velocity set value first velocity	
Index	0x31B0	
Subindex	0x02	
Data type	INTEGER32	
Access type	RW	
Default value	0	
Value range	- 120'000 rpm	+ 120'000 rpm
PDO mapping	NO	
Persistent	YES	

6.2.48.3. Velocity set value second voltage

Represents the set voltage for the second slope point. The value is given in [mV].

Name	Velocity set value second voltage	
Index	0x31B0	
Subindex	0x03	
Data type	INTEGER32	
Access type	RW	
Default value	Analog In - default value second slope point	
Value range	Analog In - value range	
PDO mapping	NO	
Persistent	YES	

Hardware	Default
ESCON2 Module 60/30 ESCON2 Compact 60/30	10'000mV
ESCON2 Micro 60/5	10'000mV
ESCON2 Nano 24/2	5'000mV

Table 74. Analog In - default value second slope point

6.2.48.4. Velocity set value second velocity

Represents the set velocity for the second slope point. The value is given in [velocity units].

Name	Velocity set value second velocity	
Index	0x31B0	
Subindex	0x04	
Data type	INTEGER32	
Access type	RW	
Default value	0	

Value range	- 120'000 rpm	+ 120'000 rpm
PDO mapping	NO	
Persistent	YES	

6.2.49. Analog input velocity set value offset scaling

A set value function for the analog input. Write access is only permitted in device state «Power Disable» (see [Device control](#)). It configures the velocity set value offset which is set by an analog input value. Invalid scaling settings (first and second voltage identical) results in the first velocity set value offset being used ([Velocity set value offset first velocity](#)). The functionality is supported in [I/O Velocity Mode \(IOVM\)](#).

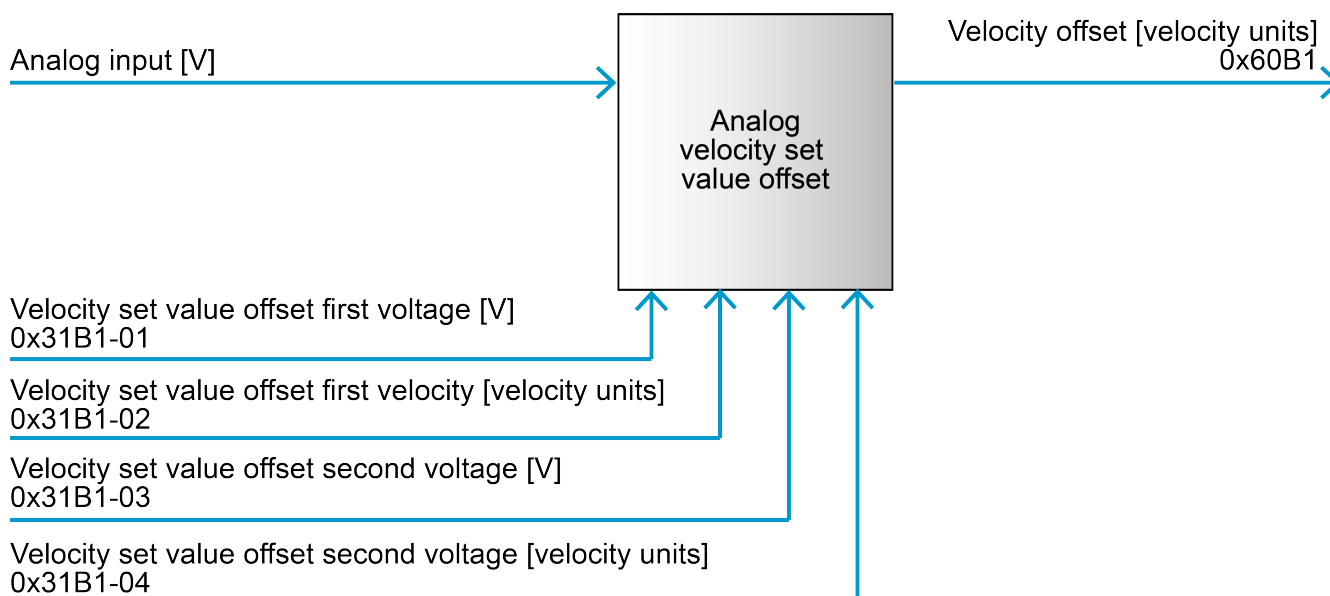

Figure 25. Analog input velocity set value offset scaling – Set value function

Name	Analog input velocity set value offset scaling
Index	0x31B1
Object code	RECORD
Highest subindex supported	4

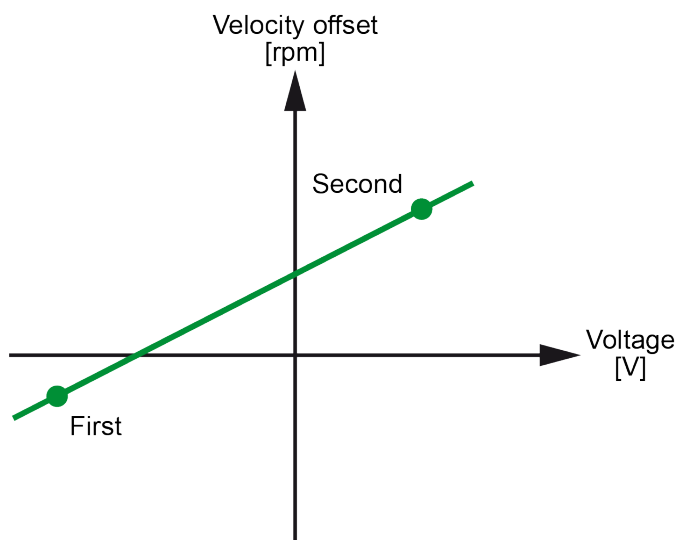

Figure 26. Analog input velocity set value offset scaling – Set value

6.2.49.1. Velocity set value offset first voltage

Represents the set voltage for the first slope point. The value is given in [mV].

Name	Velocity set value offset first voltage
Index	0x31B1
Subindex	0x01
Data type	INTEGER32
Access type	RW
Default value	Analog In - default value first slope point
Value range	Analog In - value range
PDO mapping	NO
Persistent	YES

Hardware	Default
ESCON2 Module 60/30 ESCON2 Compact 60/30	-10'000mV
ESCON2 Micro 60/5	-10'000mV
ESCON2 Nano 24/2	0mV

Table 75. Analog In - default value first slope point

Hardware	Lower Limit	Upper Limit
ESCON2 Module 60/30 ESCON2 Compact 60/30	-10'000mV	10'000mV
ESCON2 Micro 60/5	-10'000mV	10'000mV
ESCON2 Nano 24/2	0mV	5'000mV

Table 76. Analog In - value range

6.2.49.2. Velocity set value offset first velocity

Represents the set velocity for the first slope point. The value is given in [velocity units].

Name	Velocity set value offset first velocity	
Index	0x31B1	
Subindex	0x02	
Data type	INTEGER32	
Access type	RW	
Default value	0	
Value range	- 120'000 rpm	+ 120'000 rpm
PDO mapping	NO	
Persistent	YES	

6.2.49.3. Velocity set value offset second voltage

Represents the set voltage for the second slope point. The value is given in [mV].

Name	Velocity set value offset second voltage
Index	0x31B1

Subindex	0x03
Data type	INTEGER32
Access type	RW
Default value	Analog In - default value second slope point
Value range	Analog In - value range
PDO mapping	NO
Persistent	YES

Hardware	Default
ESCON2 Module 60/30 ESCON2 Compact 60/30	10'000mV
ESCON2 Micro 60/5	10'000mV
ESCON2 Nano 24/2	5'000mV

Table 77. Analog In - default value second slope point

6.2.49.4. Velocity set value offset second velocity

Represents the set velocity for the second slope point. The value is given in [[velocity units](#)].

Name	Velocity set value offset second velocity	
Index	0x31B1	
Subindex	0x04	
Data type	INTEGER32	
Access type	RW	
Default value	0	
Value range	- 120'000 rpm	+ 120'000 rpm
PDO mapping	NO	
Persistent	YES	

6.2.50. Analog input current set value scaling

A set value function for the analog input. Write access is only permitted in device state «Power Disable» (see [Device control](#)). It configures the current set value, which is set by an analog input value. Invalid scaling settings (first and second voltage identical) results in the first current being used ([Current set value first current](#)). The functionality is supported in [I/O Current Mode \(IOCM\)](#).

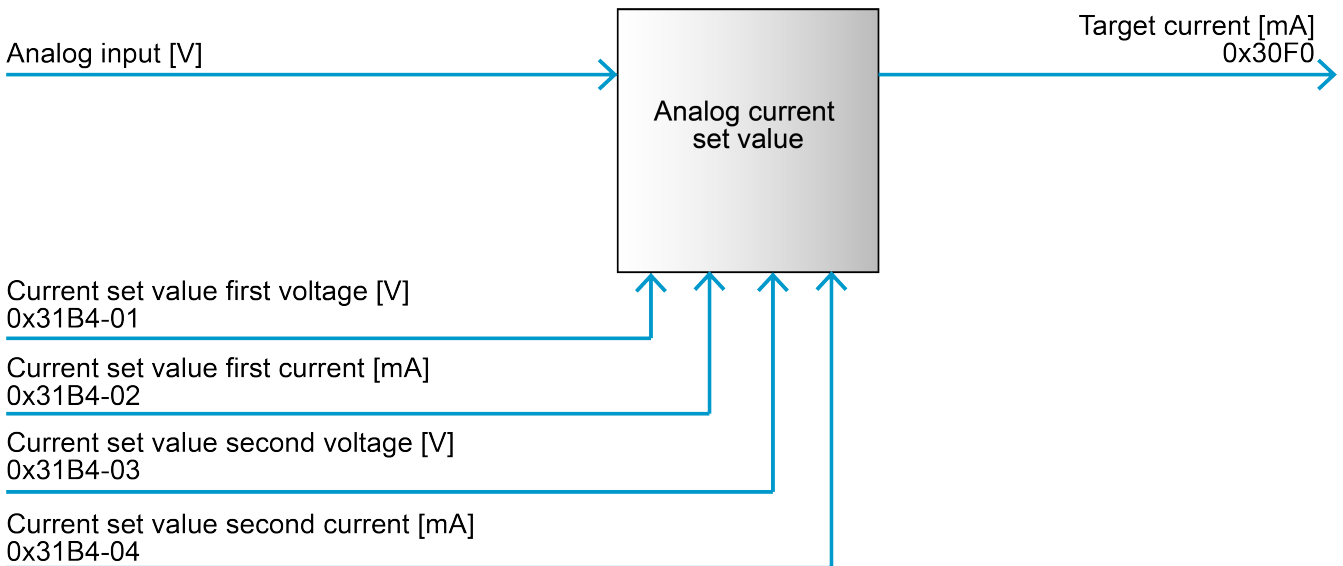

Figure 27. Analog input current set value scaling – Set value function

Name	Analog input current set value scaling
Index	0x31B4
Object code	RECORD
Highest subindex supported	4

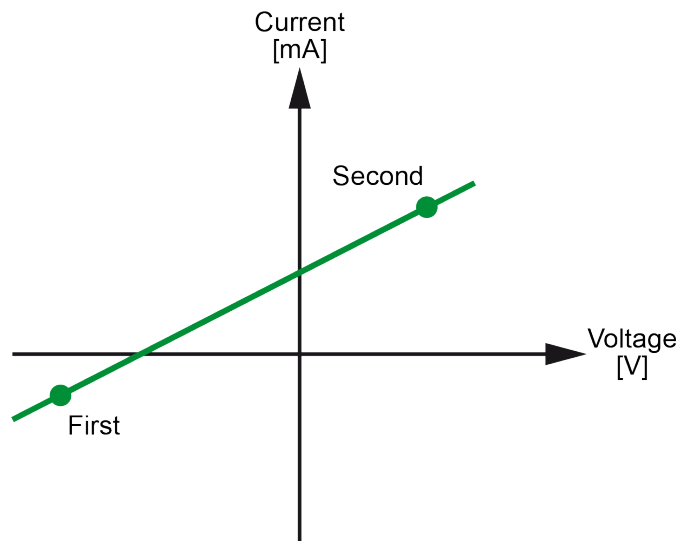

Figure 28. Analog input current set value scaling – Set value

6.2.50.1. Current set value first voltage

Represents the set voltage for the first slope point. The value is given in [mV].

Name	Current set value first voltage
Index	0x31B4
Subindex	0x01
Data type	INTEGER32
Access type	RW
Default value	Analog In - default value first slope point

Value range	Analog In - value range
PDO mapping	NO
Persistent	YES

Hardware	Default
ESCON2 Module 60/30 ESCON2 Compact 60/30	-10'000mV
ESCON2 Micro 60/5	-10'000mV
ESCON2 Nano 24/2	0mV

Table 78. Analog In - default value first slope point

Hardware	Lower Limit	Upper Limit
ESCON2 Module 60/30 ESCON2 Compact 60/30	-10'000mV	10'000mV
ESCON2 Micro 60/5	-10'000mV	10'000mV
ESCON2 Nano 24/2	0mV	5'000mV

Table 79. Analog In - value range

6.2.50.2. Current set value first current

Represents the output current for the first slope point. The value is given in [mA].

Name	Current set value first current	
Index	0x31B4	
Subindex	0x02	
Data type	INTEGER32	
Access type	RW	
Default value	0	
Value range	- Max Output current limit	+ Max Output current limit
PDO mapping	NO	
Persistent	YES	

6.2.50.3. Current set value second voltage

Represents the set voltage for the second slope point. The value is given in [mV].

Name	Current set value second voltage
Index	0x31B4
Subindex	0x03
Data type	INTEGER32
Access type	RW
Default value	Analog In - default value second slope point
Value range	Analog In - value range
PDO mapping	NO
Persistent	YES

Hardware	Default
ESCON2 Module 60/30 ESCON2 Compact 60/30	10'000mV
ESCON2 Micro 60/5	10'000mV
ESCON2 Nano 24/2	5'000mV

Table 80. Analog In - default value second slope point

6.2.50.4. Current set value second current

Represents the output current for the second slope point. The value is given in [mA].

Name	Current set value second current	
Index	0x31B4	
Subindex	0x04	
Data type	INTEGER32	
Access type	RW	
Default value	0	
Value range	- Max Output current limit	+ Max Output current limit
PDO mapping	NO	
Persistent	YES	

6.2.51. Analog input current set value offset scaling

A set value function for the analog input. Write access is only permitted in device state «Power Disable» (see [Device control](#)). It configures the current set value offset which is set by an analog input value. Invalid scaling settings (first and second voltage identical) results in the first current set value offset being used ([Current set value offset first current](#)). The functionality is supported in [I/O Current Mode \(IOCM\)](#).

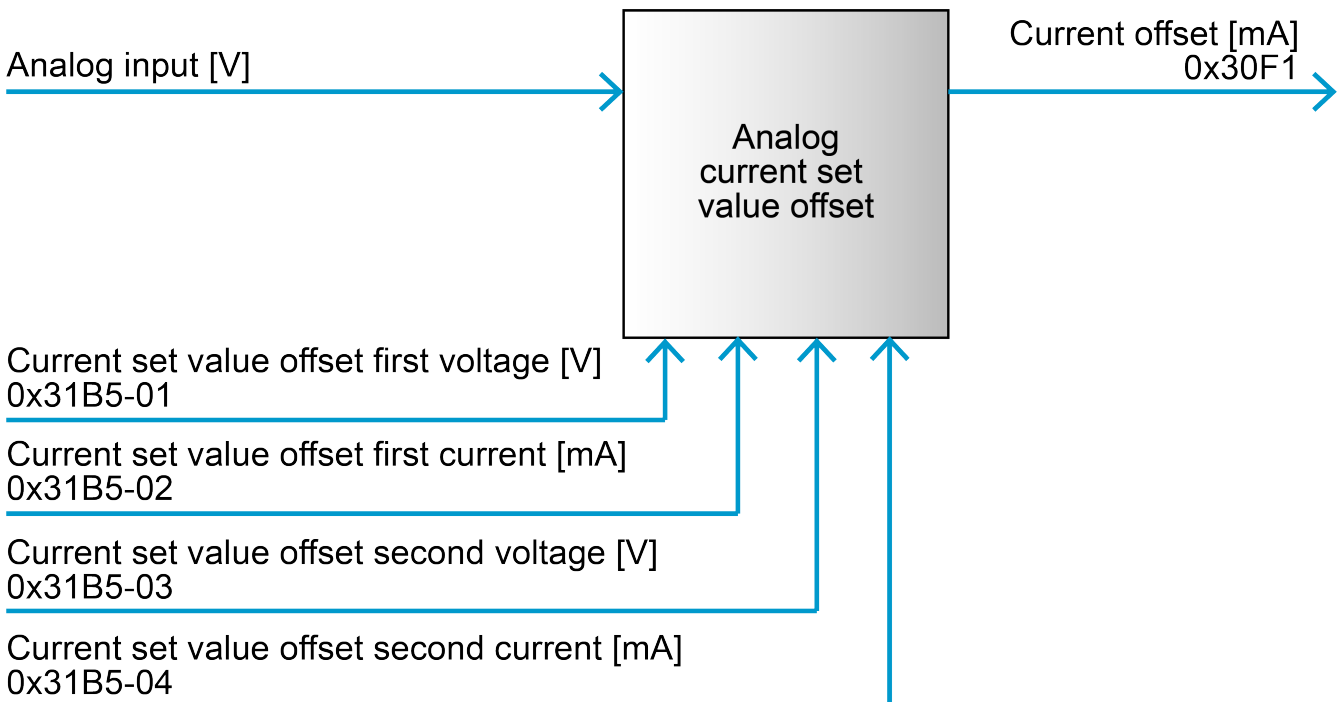

Figure 29. Analog input current set value offset scaling – Set value function

Name	Analog input current set value offset scaling
------	---

Index	0x31B5
Object code	RECORD
Highest subindex supported	4

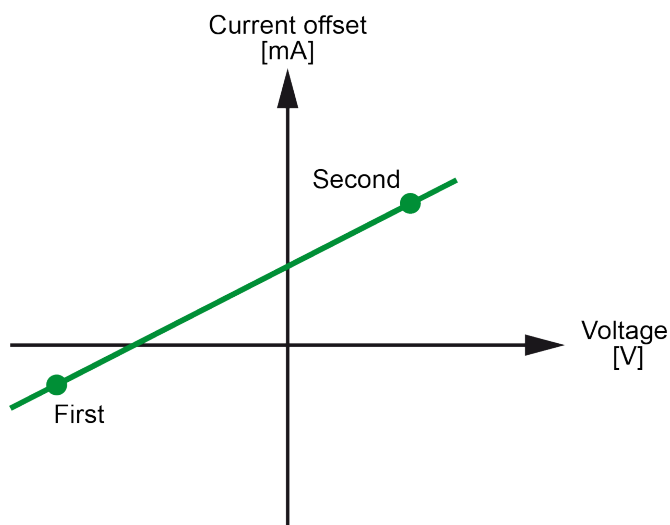

Figure 30. Analog input current set value offset scaling – Set value

6.2.51.1. Current set value offset first voltage

Represents the set voltage for the first slope point. The value is given in [mV].

Name	Current set value offset first voltage
Index	0x31B5
Subindex	0x01
Data type	INTEGER32
Access type	RW
Default value	Analog In - default value first slope point
Value range	Analog In - value range
PDO mapping	NO
Persistent	YES

Hardware	Default
ESCON2 Module 60/30 ESCON2 Compact 60/30	-10'000mV
ESCON2 Micro 60/5	-10'000mV
ESCON2 Nano 24/2	0mV

Table 81. Analog In - default value first slope point

Hardware	Lower Limit	Upper Limit
ESCON2 Module 60/30 ESCON2 Compact 60/30	-10'000mV	10'000mV
ESCON2 Micro 60/5	-10'000mV	10'000mV
ESCON2 Nano 24/2	0mV	5'000mV

Table 82. Analog In - value range

6.2.51.2. Current set value offset first current

Represents the output current for the first slope point. The value is given in [mA].

Name	Current set value offset first current	
Index	0x31B5	
Subindex	0x02	
Data type	INTEGER32	
Access type	RW	
Default value	0	
Value range	- Max Output current limit	+ Max Output current limit
PDO mapping	NO	
Persistent	YES	

6.2.51.3. Current set value offset second voltage

Represents the set voltage for the second slope point. The value is given in [mV].

Name	Current set value offset second voltage
Index	0x31B5
Subindex	0x03
Data type	INTEGER32
Access type	RW
Default value	Analog In - default value second slope point
Value range	Analog In - value range
PDO mapping	NO
Persistent	YES

Hardware	Default
ESCON2 Module 60/30 ESCON2 Compact 60/30	10'000mV
ESCON2 Micro 60/5	10'000mV
ESCON2 Nano 24/2	5'000mV

Table 83. Analog In - default value second slope point

6.2.51.4. Current set value offset second current

Represents the output current for the second slope point. The value is given in [mA].

Name	Current set value offset second current	
Index	0x31B5	
Subindex	0x04	
Data type	INTEGER32	
Access type	RW	
Default value	0	
Value range	- Max Output current limit	+ Max Output current limit
PDO mapping	NO	

Persistent	YES
------------	-----

6.2.52. Analog output velocity scaling

Configures how [Velocity actual value](#) and [Velocity actual value averaged](#) are scaled for analog output monitoring. Write access is only permitted in device state «Power Disable» (see [Device control](#)). Invalid scaling settings (first and second values identical) will output the voltage configured in [Velocity actual first voltage](#).

Related objects: [Velocity actual value](#), [Velocity actual value averaged](#), [Configuration of analog outputs](#)

Name	Analog output velocity scaling
Index	0x31C1
Object code	RECORD
Highest subindex supported	4

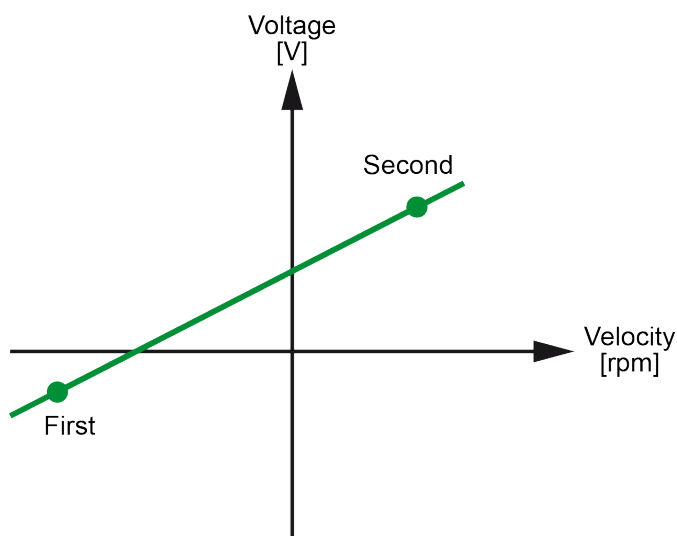

Figure 31. Analog output velocity monitor scaling

6.2.52.1. Velocity actual first velocity

Represents the velocity value for the first slope point. The value is given in [\[velocity units\]](#).

Name	Velocity actual first velocity
Index	0x31C1
Subindex	0x01
Data type	INTEGER32
Access type	RW
Default value	0
Value range	-
PDO mapping	NO
Persistent	YES

6.2.52.2. Velocity actual first voltage

Represents the output voltage for the first slope point. The value is given in [\[mV\]](#).

Name	Velocity actual first voltage
------	-------------------------------

Index	0x31C1
Subindex	0x02
Data type	INTEGER32
Access type	RW
Default value	Analog Out - default value first slope point
Value range	Analog Out - value range
PDO mapping	NO
Persistent	YES

Hardware	Default
ESCON2 Module 60/30 ESCON2 Compact 60/30	-4'000mV
ESCON2 Micro 60/5	-4'000mV
ESCON2 Nano 24/2	0mV

Table 84. Analog Out - default value first slope point

Hardware	Lower Limit	Upper Limit
ESCON2 Module 60/30 ESCON2 Compact 60/30	-4'000mV	4'000mV
ESCON2 Micro 60/5	-4'000mV	4'000mV
ESCON2 Nano 24/2	0mV	3'300mV

Table 85. Analog Out - value range

6.2.52.3. Velocity actual second velocity

Represents the velocity value for the second slope point. The value is given in [[velocity units](#)].

Name	Velocity actual second velocity	
Index	0x31C1	
Subindex	0x03	
Data type	INTEGER32	
Access type	RW	
Default value	0	
Value range	-	-
PDO mapping	NO	
Persistent	YES	

6.2.52.4. Velocity actual second voltage

Represents the output voltage for the second slope point. The value is given in [mV].

Name	Velocity actual second voltage	
Index	0x31C1	
Subindex	0x04	
Data type	INTEGER32	
Access type	RW	

Default value	Analog Out - default value second slope point
Value range	Analog Out - value range
PDO mapping	NO
Persistent	YES

Hardware	Default
ESCON2 Module 60/30 ESCON2 Compact 60/30	4'000mV
ESCON2 Micro 60/5	4'000mV
ESCON2 Nano 24/2	3'300mV

Table 86. Analog Out - default value second slope point

6.2.53. Analog output current scaling

Configures how [Current actual value averaged](#) and [Current actual value](#) are scaled for analog output monitoring. Write access is only permitted in device state «Power Disable» (see [Device control](#)). Invalid scaling settings (first and second value identical) will output the voltage configured in [Current actual first voltage](#).

Related objects: [Current actual value averaged](#), [Current actual value](#), [Configuration of analog outputs](#)

Name	Analog output current scaling
Index	0x31C2
Object code	RECORD
Highest subindex supported	4

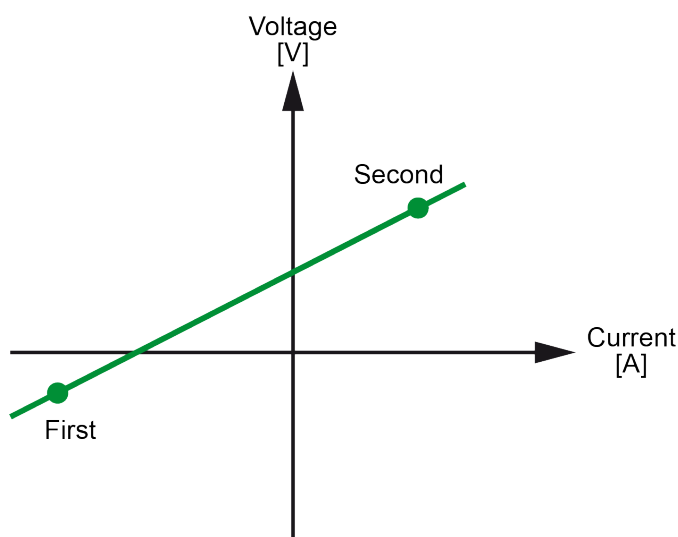

Figure 32. Analog output current monitor scaling

6.2.53.1. Current actual first current

Represents the current value for the first slope point. The value is given in [mA].

Name	Current actual first current
Index	0x31C2
Subindex	0x01
Data type	INTEGER32
Access type	RW

Default value	0	
Value range	-	-
PDO mapping	NO	
Persistent	YES	

6.2.53.2. Current actual first voltage

Represents the output voltage for the first slope point. The value is given in [mV].

Name	Current actual first voltage
Index	0x31C2
Subindex	0x02
Data type	INTEGER32
Access type	RW
Default value	Analog Out - default value first slope point
Value range	Analog Out - value range
PDO mapping	NO
Persistent	YES

Hardware	Default
ESCON2 Module 60/30 ESCON2 Compact 60/30	-4'000mV
ESCON2 Micro 60/5	-4'000mV
ESCON2 Nano 24/2	0mV

Table 87. Analog Out - default value first slope point

Hardware	Lower Limit	Upper Limit
ESCON2 Module 60/30 ESCON2 Compact 60/30	-4'000mV	4'000mV
ESCON2 Micro 60/5	-4'000mV	4'000mV
ESCON2 Nano 24/2	0mV	3'300mV

Table 88. Analog Out - value range

6.2.53.3. Current actual second current

Represents the current value for the second slope point. The value is given in [mA].

Name	Current actual second current	
Index	0x31C2	
Subindex	0x03	
Data type	INTEGER32	
Access type	RW	
Default value	0	
Value range	-	-
PDO mapping	NO	
Persistent	YES	

6.2.53.4. Current actual second voltage

Represents the output voltage for the second slope point. The value is given in [mV].

Name	Current actual second voltage
Index	0x31C2
Subindex	0x04
Data type	INTEGER32
Access type	RW
Default value	Analog Out - default value second slope point
Value range	Analog Out - value range
PDO mapping	NO
Persistent	YES

Hardware	Default
ESCON2 Module 60/30 ESCON2 Compact 60/30	4'000mV
ESCON2 Micro 60/5	4'000mV
ESCON2 Nano 24/2	3'300mV

Table 89. Analog Out - default value second slope point

6.2.54. Analog output temperature scaling

Configures how [Temperature logic section](#) and [Temperature power stage](#) are scaled for analog output monitoring. Write access is only permitted in device state «Power Disable» (see [Device control](#)). Invalid scaling settings (first and second values identical) will output the voltage configured in [Logic section temperature first voltage](#) or [Power stage temperature first voltage](#) respectively.

Related objects: [Temperature logic section](#), [Temperature power stage](#), [Configuration of analog outputs](#)

Name	Analog output temperature scaling
Index	0x31C3
Object code	RECORD
Highest subindex supported	8

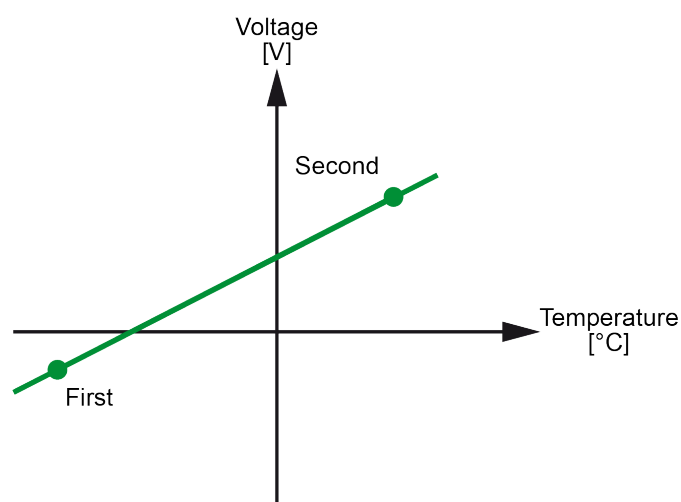

Figure 33. Analog output temperature monitor scaling

6.2.54.1. Logic section temperature first temperature

Represents the temperature value for the first slope point. The value is given in [0.1 °C].

Name	Logic section temperature first temperature	
Index	0x31C3	
Subindex	0x01	
Data type	INTEGER32	
Access type	RW	
Default value	0	
Value range	-	-
PDO mapping	NO	
Persistent	YES	

6.2.54.2. Logic section temperature first voltage

Represents the output voltage for the first slope point. The value is given in [mV].

Name	Logic section temperature first voltage	
Index	0x31C3	
Subindex	0x02	
Data type	INTEGER32	
Access type	RW	
Default value	Analog Out - default value first slope point	
Value range	Analog Out - value range	
PDO mapping	NO	
Persistent	YES	

Hardware	Default
ESCON2 Module 60/30 ESCON2 Compact 60/30	-4'000mV
ESCON2 Micro 60/5	-4'000mV
ESCON2 Nano 24/2	0mV

Table 90. Analog Out - default value first slope point

Hardware	Lower Limit	Upper Limit
ESCON2 Module 60/30 ESCON2 Compact 60/30	-4'000mV	4'000mV
ESCON2 Micro 60/5	-4'000mV	4'000mV
ESCON2 Nano 24/2	0mV	3'300mV

Table 91. Analog Out - value range

6.2.54.3. Logic section temperature second temperature

Represents the temperature value for the second slope point. The value is given in [0.1 °C].

Name	Logic section temperature second temperature	
Index	0x31C3	

Subindex	0x03
Data type	INTEGER32
Access type	RW
Default value	0
Value range	-
PDO mapping	NO
Persistent	YES

6.2.54.4. Logic section temperature second voltage

Represents the output voltage for the second slope point. The value is given in [mV].

Name	Logic section temperature second voltage
Index	0x31C3
Subindex	0x04
Data type	INTEGER32
Access type	RW
Default value	Analog Out - default value second slope point
Value range	Analog Out - value range
PDO mapping	NO
Persistent	YES

Hardware	Default
ESCON2 Module 60/30 ESCON2 Compact 60/30	4'000mV
ESCON2 Micro 60/5	4'000mV
ESCON2 Nano 24/2	3'300mV

Table 92. Analog Out - default value second slope point

6.2.54.5. Power stage temperature first temperature

Represents the temperature value for the first slope point. The value is given in [0.1 °C].

Name	Power stage temperature first temperature
Index	0x31C3
Subindex	0x05
Data type	INTEGER32
Access type	RW
Default value	0
Value range	-
PDO mapping	NO
Persistent	YES

6.2.54.6. Power stage temperature first voltage

Represents the output voltage for the first slope point. The value is given in [mV].

Name	Power stage temperature first voltage
Index	0x31C3
Subindex	0x06
Data type	INTEGER32
Access type	RW
Default value	Analog Out - default value first slope point
Value range	Analog Out - value range
PDO mapping	NO
Persistent	YES

Hardware	Default
ESCON2 Module 60/30 ESCON2 Compact 60/30	-4'000mV
ESCON2 Micro 60/5	-4'000mV
ESCON2 Nano 24/2	0mV

Table 93. Analog Out - default value first slope point

6.2.54.7. Power stage temperature second temperature

Represents the temperature value for the second slope point. The value is given in [0.1 °C].

Name	Power stage temperature second temperature
Index	0x31C3
Subindex	0x07
Data type	INTEGER32
Access type	RW
Default value	0
Value range	-
PDO mapping	NO
Persistent	YES

6.2.54.8. Power stage temperature second voltage

Represents the output voltage for the second slope point. The value is given in [mV].

Name	Power stage temperature second voltage
Index	0x31C3
Subindex	0x08
Data type	INTEGER32
Access type	RW
Default value	Analog Out - default value second slope point
Value range	Analog Out - value range
PDO mapping	NO
Persistent	YES

Hardware	Default
ESCON2 Module 60/30 ESCON2 Compact 60/30	4'000mV
ESCON2 Micro 60/5	4'000mV
ESCON2 Nano 24/2	3'300mV

Table 94. Analog Out - default value second slope point

6.2.55. Thermal protection motor

Represents the model-based I2t power limitation parameters.

Name	Thermal protection motor
Index	0x3200
Object code	RECORD
Highest subindex supported	1

6.2.55.1. I2t level motor

Provides the actual thermal state of the internal i2t motor protection feature. The number is given in percent, values higher than 100% are possible.

Name	I2t level motor
Index	0x3200
Subindex	0x01
Data type	UNSIGNED16
Access type	RO
Default value	-
Value range	-
PDO mapping	TXPDO
Persistent	NO

6.2.56. Thermal protection power stage

Limits output current based on [power stage temperature](#) and [I2t model](#). The smaller of the two output values is used as the limit after accounting for both values.

Note:



For ESCON2 Nano 24/2, the output current is limited based only on the [power stage temperature](#); the [I2t model](#) is not used.

Name	Thermal protection power stage
Index	0x3201
Object code	RECORD
Highest subindex supported	3

6.2.56.1. I2t level power stage

Provides the actual thermal state of the internal i2t power stage protection feature. The number is given in

percent, values higher than 100% are possible.

Name	I2t level power stage
Index	0x3201
Subindex	0x01
Data type	UNSIGNED16
Access type	RO
Default value	-
Value range	-
PDO mapping	TXPDO
Persistent	NO

6.2.56.2. Temperature power stage

Displays the power stage temperature. The value is given in [0.1 °C].

From the warning temperature, the [maximum allowed output current](#) is linearly reduced with increasing temperature up to the maximum temperature. The [Thermal power stage overload warning](#) cannot be removed while restrictions are in effect. Once the temperature drops below the warning threshold, it could be cleared. Upon reaching the upper limit, [Thermal power stage overload error](#) is set, which disables the device.

Name	Temperature power stage
Index	0x3201
Subindex	0x02
Data type	INTEGER16
Access type	RO
Default value	-
Value range	-
PDO mapping	TXPDO
Persistent	NO

Hardware	Warning	Disable
ESCON2 Module 60/30 ESCON2 Compact 60/30	Max temperature power stage - 10°C	Max temperature power stage
ESCON2 Micro 60/5	Max temperature power stage - 10°C	Max temperature power stage
ESCON2 Nano 24/2	Max temperature power stage - 10°C	Max temperature power stage

Table 95. Temperature power stage - Temperature limits

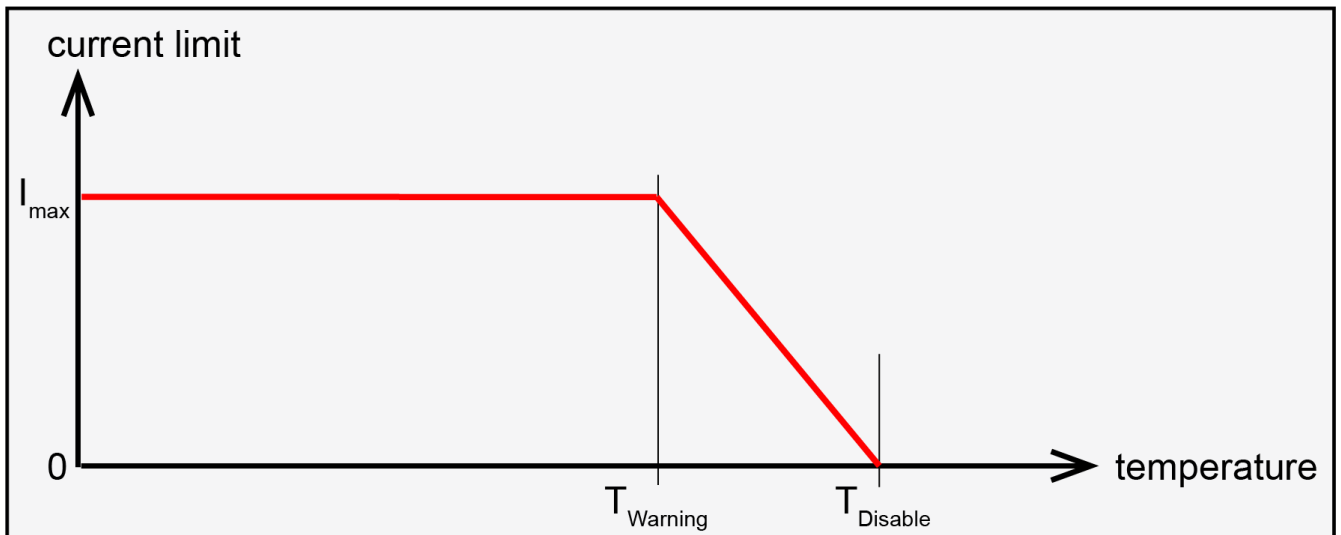

6.2.56.3. Max temperature power stage

Maximum power stage temperature [0.1 °C]. The power stage is turned off when [Temperature power stage](#) reaches this level.

Name	Max temperature power stage
Index	0x3201
Subindex	0x03
Data type	UNSIGNED16
Access type	RW
Default value	Max temperature power stage
Value range	Max temperature power stage
PDO mapping	NO
Persistent	YES

Hardware	Default	Min	Max
ESCON2 Module 60/30 ESCON2 Compact 60/30	110°C	0°C	110°C
ESCON2 Micro 60/5	100°C	0°C	100°C
ESCON2 Nano 24/2	90°C	0°C	90°C

Table 96. Max temperature power stage

6.2.57. Motor control

Handles the motor control.

Name	Motor control
Index	0x3203
Object code	RECORD
Highest subindex supported	1

6.2.57.1. PWM duty cycle actual value

Displays the motor's actual duty cycle for the PWM signal of the output stage. The value is given in [0.1%].

If the value reaches the [PWM max duty cycle](#) the limitation bit in [Statusword](#) will be set.
Related object: [Statusword](#)

Name	PWM duty cycle actual value	
Index	0x3203	
Subindex	0x01	
Data type	UNSIGNED16	
Access type	RO	
Default value	-	
Value range	-	-
PDO mapping	TXPDO	
Persistent	NO	

Hardware	Max
ESCON2 Module 60/30 ESCON2 Compact 60/30	950 [0.1%]
ESCON2 Micro 60/5	950 [0.1%]
ESCON2 Nano 24/2	900 [0.1%]

Table 97. PWM max duty cycle

6.2.58. Error code

Provides the error code of the last error or warning that occurred in the device. Note that a non-erasable error takes priority over an erasable error, which takes priority over a warning. The error code of a warning is only represented in this object while the warning is active. The object [Error history](#) contains the detailed listing of the errors. This value differs from the value in object [Error register](#).

Name	Error code	
Index	0x603F	
Subindex	0x00	
Data type	UNSIGNED16	
Access type	RO	
Default value	-	
Value range	-	-
PDO mapping	TXPDO	
Persistent	NO	

6.2.59. Controlword

Comprises bits for the following items:

- [Device control commands](#) (bits 0...3, 7)
- Supervision of operating modes (bits 4...6, 8):

For bit patterns of triggered commands, see [Device control commands](#)

Related object: [Statusword](#)

Name	Controlword
------	-------------

Index	0x6040	
Subindex	0x00	
Data type	UNSIGNED16	
Access type	RW	
Default value	-	
Value range	-	-
PDO mapping	RXPDO	
Persistent	NO	

Bit	Description	IOVM	IOCM
15	Operating mode-specific	Reserved	Reserved
14... 11	Reserved		
10, 9	Reserved		
8	Operating mode-specific		
7	Fault reset		
6	Operating mode-specific		
5	Operating mode-specific		
4	Operating mode-specific		
3	Enable operation		
2	Quick stop		
1	Enabled voltage		
0	Switched on		

Table 98. Controlword bits

6.2.60. Statusword

Comprises bits for the following items:

- [State of the drive](#)
- Operating state of the mode (bits 10, 12, and 13):
 - [Statusword \(I/O Velocity Mode - Specific Bits\)](#)
 - [Statusword \(I/O current mode - Specific bits\)](#)
- Internal limit active, see [Limits in IOVM](#), [Limits in IOCM](#)
- Warning (bit 7: indicates the presence of a warning condition)

Related object: [Controlword](#).

Name	Statusword	
Index	0x6041	
Subindex	0x00	
Data type	UNSIGNED16	
Access type	RO	
Default value	-	
Value range	-	-

PDO mapping	TXPDO
Persistent	NO

Bit	Description	IOVM	IOCM
15	Reserved		
14	Reserved		
13	Operating mode-specific		
12	Operating mode-specific	Drive follows command value	Drive follows command value
11	Internal limit active	I2t, Current, Max motor speed, Supply voltage	I2t, Current, Max motor speed, Supply voltage
10	Operating mode-specific	Reserved	Reserved
9	Remote		
8	Reserved (0)		
7	Warning		
6	Switch on disabled		
5	Quick stop		
4	Voltage enabled (power stage on)		
3	Fault		
2	Operation enabled		
1	Switched on		
0	Ready to switch on		

Table 99. Statusword bits

6.2.61. Modes of operation

Switches the actual chosen operating mode. We recommend to using [Modes of operation display](#) after changing the operation mode.

Related object: [Modes of operation display](#)

Name	Modes of operation
Index	0x6060
Subindex	0x00
Data type	INTEGER8
Access type	RW
Default value	-121
Value range	Modes of operation
PDO mapping	RXPDO
Persistent	YES

Operation mode	Description
-121	I/O Velocity Mode (IOVM)
-120	I/O Current Mode (IOCM)

Table 100. Modes of operation

6.2.62. Modes of operation display

Displays the actual mode of operation. The meaning of the returned value corresponds to the code in [Modes of operation](#).

Related object: [Modes of operation](#)

Name	Modes of operation display
Index	0x6061
Subindex	0x00
Data type	INTEGER8
Access type	RO
Default value	-
Value range	Modes of operation
PDO mapping	TXPDO
Persistent	NO

6.2.63. Velocity demand value

Used as input for the velocity controller. The value is given in [[velocity units](#)].

Name	Velocity demand value
Index	0x606B
Subindex	0x00
Data type	INTEGER32
Access type	RO
Default value	-
Value range	-
PDO mapping	TXPDO
Persistent	NO

6.2.64. Velocity actual value

Provides the actual velocity value of the axis derived by the main sensor defined in [Axis configuration](#). If no main sensor is configured, an estimated velocity is displayed. The value is given in [[velocity units](#)].

Related objects: [Velocity actual values](#), [Additional velocity actual values](#)

Name	Velocity actual value
Index	0x606C
Subindex	0x00
Data type	INTEGER32
Access type	RO
Default value	-
Value range	-
PDO mapping	TXPDO
Persistent	NO

6.2.65. Motor rated torque

Holds the value to which all torque objects are related. The value is defined as [Nominal current](#) multiplied by the [Torque constant](#). The value is given in [μ Nm].

Changing the value with write access is not permitted.

Related object: [Motor data](#)

Name	Motor rated torque	
Index	0x6076	
Subindex	0x00	
Data type	UNSIGNED32	
Access type	RW	
Default value	0	
Value range	-	-
PDO mapping	NO	
Persistent	NO	

6.2.66. Torque actual value

Provides the actual torque and corresponds to the motor's instantaneous torque. The value is given in per thousand of [Motor rated torque](#).

Related object: [Motor rated torque](#)

Name	Torque actual value	
Index	0x6077	
Subindex	0x00	
Data type	INTEGER16	
Access type	RO	
Default value	-	
Value range	-	-
PDO mapping	TXPDO	
Persistent	NO	

6.2.67. Max profile velocity

Used as a velocity limit in regulation tuning.

The value is given in [[velocity units](#)].

Name	Max profile velocity	
Index	0x607F	
Subindex	0x00	
Data type	UNSIGNED32	
Access type	RW	
Default value	120'000	
Value range	1	Max motor speed
PDO mapping	RXPDO	
Persistent	YES	

6.2.68. Max motor speed

Indicates the configured maximum allowed speed for the motor. It serves as protection for the motor. The value is given in [rpm]. For detailed motor specifications, see the maxon catalog.

Related objects:

- [Motor type](#)
- [Number of pole pairs](#)
- [Target velocity](#)

Name	Max motor speed
Index	0x6080
Subindex	0x00
Data type	UNSIGNED32
Access type	RW
Default value	120'000
Value range	Max motor speed values
PDO mapping	RXPDO
Persistent	YES

Motor type	Description	Maximum speed [rpm]
1	Brushed DC motor (maxon DC motor)	120'000
10	Brushless DC motor (maxon EC motor/BLDC motor), sinus commutated	120'000 / number of pole pairs

Table 101. Max motor speed values

6.2.69. Profile acceleration

Defines the acceleration value used during a profiled move. The value is given in [[acceleration units](#)]. Supported mode is [I/O Velocity Mode \(IOVM\)](#).

Name	Profile acceleration
Index	0x6083
Subindex	0x00
Data type	UNSIGNED32
Access type	RW
Default value	10'000
Value range	1 Max acceleration
PDO mapping	RXPDO
Persistent	YES

6.2.70. Profile deceleration

Defines the deceleration value used during a profiled move. The value is given in [[acceleration units](#)]. Supported mode is [I/O Velocity Mode \(IOVM\)](#).

Name	Profile deceleration
------	----------------------

Index	0x6084		
Subindex	0x00		
Data type	UNSIGNED32		
Access type	RW		
Default value	10'000		
Value range	1	Max acceleration	
PDO mapping	RXPDO		
Persistent	YES		

6.2.71. Quick stop deceleration

Determines the deceleration of the quick stop profile.

Is also be used with a «quick stop» command (see [Device control commands](#)).

The value is given in [\[acceleration units\]](#).

Related object: [Controlword](#)

Name	Quick stop deceleration		
Index	0x6085		
Subindex	0x00		
Data type	UNSIGNED32		
Access type	RW		
Default value	10'000		
Value range	1	Max acceleration	
PDO mapping	RXPDO		
Persistent	YES		

6.2.72. SI unit velocity

Defines the velocity units. The coding of the user-defined units and prefixes follows [System units](#).

Write access is only permitted in the device state «Power Disable» [Device control](#).

Name	SI unit velocity		
Index	0x60A9		
Subindex	0x00		
Data type	UNSIGNED32		
Access type	RW		
Default value	0x00B44700		
Value range	SI Units Velocity - value range		
PDO mapping	NO		
Persistent	YES		

Bit 31...24	Bit 24...16	Bit 15...8	Bit 7...0
Prefix	Numerator	Denominator	Reserved(0)

Table 102. SI Units Velocity - Bits

Value	Description	Symbol
0x00B44700	Revolutions/minute	rev/min (rpm)
0xFDB44700	0.001 revolutions/minute	milli rev/min (mrpm)

Table 103. SI Units Velocity - value range

6.2.73. SI unit acceleration

Defines the acceleration units. The coding of the user-defined units and prefixes follows [System units](#).

Write access is only permitted in the device state «Power Disable» [Device control](#).

Name	SI unit acceleration
Index	0x60AA
Subindex	0x00
Data type	UNSIGNED32
Access type	RW
Default value	0x00C00300
Value range	SI Units Acceleration - value range
PDO mapping	NO
Persistent	YES

Bit 31...24	Bit 24...16	Bit 15...8	Bit 7...0
Prefix	Numerator	Denominator	Reserved(0)

Table 104. SI Units Acceleration - Bits

Value	Description	Symbol
0x00C00300	(Revolutions/minute)/second	rpm/s

Table 105. SI Units Acceleration - value range

6.2.74. Velocity offset

The velocity offset value is internally added to the [Target velocity](#). The value is given in [[velocity units](#)]. Supported mode is [I/O Velocity Mode \(IOVM\)](#).

Name	Velocity offset
Index	0x60B1
Subindex	0x00
Data type	INTEGER32
Access type	RW
Default value	0
Value range	-
PDO mapping	RXPDO
Persistent	NO

6.2.75. Max acceleration

Used to limit the maximum allowed acceleration to prevent mechanical damage. It represents the limit of all other acceleration/deceleration objects on the axis.

The value is given in [\[acceleration units\]](#).
Operation mode IOCM is not limited by this value.

Related objects: [Quick stop deceleration](#)

Name	Max acceleration	
Index	0x60C5	
Subindex	0x00	
Data type	UNSIGNED32	
Access type	RW	
Default value	4'294'967'295	
Value range	1	4'294'967'295
PDO mapping	RXPDO	
Persistent	YES	

6.2.76. Additional velocity actual values

Provides the actual velocity values of the axis derived by the sensors defined in [Axis configuration](#). If no sensor is configured in the corresponding field, the actual velocity value is "0" (zero).

The value is given in [\[velocity units\]](#).

The averaged velocity values represent the actual velocity value filtered by a 1st, order digital low-pass filter with a cut-off frequency of 5 Hz.

Related objects: [Velocity actual values](#), [Velocity actual value](#)

Name	Additional velocity actual values	
Index	0x60E5	
Object code	ARRAY	
Highest subindex supported	10	

6.2.76.1. Velocity actual value sensor 1

Name	Velocity actual value sensor 1	
Index	0x60E5	
Subindex	0x01	
Data type	INTEGER32	
Access type	RO	
Default value	-	
Value range	-	-
PDO mapping	TXPDO	
Persistent	NO	

6.2.76.2. Velocity actual value sensor 2

Name	Velocity actual value sensor 2	
Index	0x60E5	
Subindex	0x02	
Data type	INTEGER32	
Access type	RO	

Default value	-	
Value range	-	-
PDO mapping	TXPDO	
Persistent	NO	

6.2.76.3. Velocity actual value averaged sensor 1

Name	Velocity actual value averaged sensor 1	
Index	0x60E5	
Subindex	0x09	
Data type	INTEGER32	
Access type	RO	
Default value	-	
Value range	-	-
PDO mapping	TXPDO	
Persistent	NO	

6.2.76.4. Velocity actual value averaged sensor 2

Name	Velocity actual value averaged sensor 2	
Index	0x60E5	
Subindex	0x0A	
Data type	INTEGER32	
Access type	RO	
Default value	-	
Value range	-	-
PDO mapping	TXPDO	
Persistent	NO	

6.2.77. Digital inputs

Displays the state of the CiA digital input functionalities (after polarity correction by [Digital input properties](#), Polarity). A bit is read as "1" if the signal at the corresponding pin is high. This value is a subset of [Digital inputs functionality](#).

Related objects: [Digital input properties](#) / [Configuration of digital inputs](#), [Digital inputs functionality](#)

Name	Digital inputs	
Index	0x60FD	
Subindex	0x00	
Data type	UNSIGNED32	
Access type	RO	
Default value	-	
Value range	-	-
PDO mapping	TXPDO	
Persistent	NO	

Bit	Functionality	Description
31..24	Reserved	–
23	General purpose H	State can be read
22	General purpose G	State can be read
21	General purpose F	State can be read
20	General purpose E	State can be read
19	General purpose D	State can be read
18	General purpose C	State can be read
17	General purpose B	State can be read
16	General purpose A	State can be read
15..2	Reserved	-
1	Positive limit switch	Generates Positive limit switch error
0	Negative limit switch	Generates Negative limit switch error

Table 106. Digital Inputs

6.2.78. Digital outputs

Configures the state of the digital output functionalities (before polarity correction by [Digital outputs polarity](#)). If a bit is set to “1” and the polarity bit is set to “0”, the signal at the corresponding pin is high.

This value is a CiA-conforming subset of [Digital outputs functionality](#)

Related objects: [Digital outputs properties](#), [Configuration of digital outputs](#), [Digital outputs functionality](#).

Name	Digital outputs
Index	0x60FE
Object code	ARRAY
Highest subindex supported	1

6.2.78.1. Physical outputs

This object is read/write, however, bits 24→31 are ignored upon writing.

Name	Physical outputs
Index	0x60FE
Subindex	0x01
Data type	UNSIGNED32
Access type	RW
Default value	0x0
Value range	Digital outputs - values
PDO mapping	RXPDO
Persistent	NO

Bit	Functionality	Description
31..19	Reserved	-
18	General purpose C	State can be read/written by the host
17	General purpose B	State can be read/written by the host
16	General purpose A	State can be read/written by the host

Bit	Functionality	Description
15...0	Reserved	-

Table 107. Digital outputs - values

6.2.79. Target velocity

Indicates the configured target velocity and is used as input for the trajectory generator. The value is given in [velocity units]. Supported mode is [I/O Velocity Mode \(IOVM\)](#).

Related objects:

- [Max motor speed](#)

Name	Target velocity	
Index	0x60FF	
Subindex	0x00	
Data type	INTEGER32	
Access type	RW	
Default value	0	
Value range	-	-
PDO mapping	RXPDO	
Persistent	NO	

6.2.80. Motor type

Defines the motor type. Changes are only supported in device state «Power Disable» [Device control](#).

Related objects: [Axis configuration](#), [Motor data](#)

Name	Motor type	
Index	0x6402	
Subindex	0x00	
Data type	UNSIGNED16	
Access type	RW	
Default value	10	
Value range	Motor type values	
PDO mapping	NO	
Persistent	YES	

Value	DS-402 Name	Description
1	Phase-modulated DC motor	Brushed DC motor (maxon DC motor)
10	Sinusoidal PM BL motor	Brushless DC motor BLDC sinus commutated (maxon EC motor)

Table 108. Motor type values

6.2.81. Supported drive modes

Provides an overview of the implemented operating modes on the device. Supported are the following modes:

- [I/O Velocity Mode \(IOVM\)](#)

- [I/O Current Mode \(IOCM\)](#)

Name	Supported drive modes	
Index	0x6502	
Subindex	0x00	
Data type	UNSIGNED32	
Access type	RO	
Default value	0x0006'0000	
Value range	-	-
PDO mapping	TXPDO	
Persistent	NO	

Bit		Description
31...19	0	Reserved
18	1	I/O Current Mode (IOCM)
17	1	I/O Velocity Mode (IOVM)
16...11	0	Reserved
10	0	Cyclic Synchronous Torque Mode With Commutation Angle (CSTCA)
9	0	Cyclic Synchronous Torque Mode (CST)
8	0	Cyclic Synchronous Velocity Mode (CSV)
7	0	Cyclic Synchronous Position Mode (CSP)
6	0	Interpolated Position Mode (IPM)
5	0	Homing Mode (HMM)
4	0	Reserved
3	0	Torque Mode
2	0	Profile Velocity Mode (PVM)
1	0	Velocity Mode
0	0	Profile Position Mode (PPM)

Table 109. Supported drive modes - Bits

7. Error Handling

7.1. Device errors

The device can detect a variety of device errors. The reaction to an error depends on the error type and Fault reaction code. After execution of the fault reaction, the device changes to a fault state, and the drive will be disabled.

The [Error history](#) holds the error codes that occurred.

The [Error register](#) holds all set error flags and provides a summary of possible errors.

For fault reaction codes, the following notations will be used:

- f: Decelerate with a quick stop ramp and disable the drive function
- d: A secure movement is no longer possible; disable the drive function
- w: No effect on device status (warning)

Error code	Error register	Name	Fault reaction code
0x0000	0000 0000b	No Error	-
0x1000	0000 0001b	Generic error	d
0x1080	0000 0001b	Generic initialisation error	d
0x2310	0000 0011b	Overcurrent error	d
0x2320	0000 0011b	Power stage protection error	d
0x2380	0000 0011b	Power stage protection error	d
0x3210	0000 0101b	Overvoltage error	d
0x3220	0000 0101b	Undervoltage error	d
0x4382	0000 1001b	Thermal power stage overload error	d
0x4383	0000 1001b	Thermal power stage overload warning	w
0x4384	0000 1001b	Thermal logic section overload error	d
0x5480	0000 0001b	Hardware error	d
0x5481	0000 0001b	Hardware defect loading parameter error	d
0x5482	0000 0001b	Hardware configuration error	d
0x5483	0000 0001b	Hardware configuration error	d
0x6180	0000 0001b	Internal software error	d
0x6181	0000 0001b	Internal software error	d
0x6380	0000 0001b	Loading parameter failed error	d
0x6381	0000 0001b	Loading parameter failed error	d
0x6382	0000 0001b	Loading parameter failed error	d
0x6388	0000 0001b	Torque constant parameter error	d
0x7280	0000 0001b	Current offset adjustment warning	w
0x7380	0010 0001b	Main sensor breach error	d
0x7388	0010 0001b	Hall sensor signal error	d
0x738A	0010 0001b	Hall angle detection error	d
0x7390	0010 0001b	Missing main sensor error	d

Error code	Error register	Name	Fault reaction code
0x7391	0010 0001b	Missing commutation sensor error	d
0x7392	0010 0001b	Main sensor direction error	d
0x8A80	0010 0001b	Negative limit switch error	f
0x8A81	0010 0001b	Positive limit switch error	f
0x8A89	0000 0001b	Digital input 1 PWM frequency warning	w
0x8A8A	0000 0001b	Digital input 1 PWM duty cycle warning	w
0x8A8C	0000 0001b	Digital input 1 PWM error	d
0x8A8D	0000 0001b	Digital input 2 PWM frequency warning	w
0x8A8E	0000 0001b	Digital input 2 PWM duty cycle warning	w
0x8A90	0000 0001b	Digital input 2 PWM error	d
0xFF01	0000 0001b	System overloaded warning	w
0xFF02	0000 0001b	Watchdog error	d
0xFF03	0000 0001b	Watchdog error	d
0xFF06	0000 0001b	System peak overloaded error	d
0xFF07	0000 0001b	System peak overloaded error	d
0xFF0D	0000 0001b	Mode of operation not supported error	d
0xFF11	0010 0001b	Regulation tuning identification error	d
0xFF12	0010 0001b	Regulation tuning current error	d
0xFF13	0010 0001b	Regulation tuning identification current error	d
0xFF14	0010 0001b	Regulation tuning unrealistic result error	d
0xFF15	0010 0001b	Regulation tuning identification error	d
0xFF16	0010 0001b	Regulation tuning identification error	d
0xFF17	0010 0001b	Regulation tuning identification error	d
0xFF19	0010 0001b	Regulation tuning identification error	d
0xFF20	0010 0001b	Regulation tuning standstill error	d
0xFF21	0010 0001b	Regulation tuning torque constant error	d
0xFF22	0010 0001b	Regulation tuning max system speed error	d
0xFF23	0010 0001b	Regulation tuning motor connection error	d
0xFF24	0010 0001b	Regulation tuning sensor signal error	d

Table 110. Device error codes

7.1.1. Generic error

Error code	0x1000
Error register	0000 0001b
Cause	Unspecific error occurred
Effect	Device disabled Red LED "ON" Error bit set in Statusword
Error recovery	Reset fault with Controlword

7.1.2. Generic initialisation error

Error code	0x1080
Error register	0000 0001b
Cause	Critical error occurred during boot-up.
Effect	Device disabled Red LED "ON" Error bit set in Statusword
Error recovery	Reset device. If the problem persists, contact your supplier.

7.1.3. Overcurrent error

Error code	0x2310
Error register	0000 0011b
Cause	Short circuit in motor winding. Controller gains too high and/or deceleration too high. Damaged power stage.
Effect	Device disabled Red LED "ON" Error bit set in Statusword
Error recovery	Reset fault with Controlword

7.1.4. Power stage protection error

Error code	0x2320
Error register	0000 0011b
Cause	Short circuit of the motor winding against the ground. Short circuit of motor winding against operating voltage Vcc. Damaged power stage. Strong motor ripple (on top of a high peak current draw). High deceleration or acceleration demands (which push the control to its limits). Max. peak current configured, which is close to the power stage current protection level. Poor current control parameter set. Possible loose contact.
Effect	Device disabled Red LED "ON" Error bit set in Statusword
Error recovery	Reset fault with Controlword

7.1.5. Power stage protection error

Error code	0x2380
Error register	0000 0011b
Cause	Short circuit of the motor winding against the ground. Short circuit of motor winding against operating voltage Vcc. Damaged power stage. Strong motor ripple (on top of a high peak current draw). High deceleration or acceleration demands (which push the control to its limits). Max. peak current configured, which is close to the power stage current protection level. Poor current control parameter set. Possible loose contact.
Effect	Device disabled Red LED "ON" Error bit set in Statusword
Error recovery	Reset fault with Controlword

7.1.6. Overvoltage error

Error code	0x3210
------------	--------

Error register	0000 0101b
Cause	Power supply voltage too high.
Effect	Device disabled Red LED "ON" Error bit set in Statusword
Error recovery	In most cases, this error occurs at deceleration, where the motor works as a generator and the energy flows from the motor to the power supply (resulting in an increased voltage). Usually, a capacitor (for example, 2200 µF) close to the device will solve the problem. If not, a shunt regulator will be necessary to dissipate brake energy. Reset the fault with Controlword (only possible if the supply voltage is in a valid range).

7.1.7. Undervoltage error

Error code	0x3220
Error register	0000 0101b
Cause	Either: - Supply voltage is too low for operation. - Power supply cannot supply the required acceleration current.
Effect	Device disabled Red LED "ON" Error bit set in Statusword
Error recovery	Reset fault with Controlword (only possible if the supply voltage is in a valid range or the drive is not enabled).

7.1.8. Thermal power stage overload error

Error code	0x4382
Error register	0000 1001b
Cause	Temperature power stage reached critical level.
Effect	Device disabled Red LED "ON" Error bit set in Statusword
Error recovery	Reset fault with Controlword when the temperature has fallen below the critical threshold.

7.1.9. Thermal power stage overload warning

Error code	0x4383
Error register	0000 1001b
Cause	Temperature power stage is high.
Effect	Maximum output current is actively reduced with rising temperatures. Red LED "Slow" Warning bit set in Statusword
Error recovery	The warning auto clears if the temperature falls below the warning threshold.

7.1.10. Thermal logic section overload error

Error code	0x4384
Error register	0000 1001b
Cause	Temperature logic section reached critical level.
Effect	Device disabled Red LED "ON" Error bit set in Statusword
Error recovery	Reset fault with Controlword (only possible if temperature is in a valid range)

7.1.11. Hardware error

Error code	0x5480
Error register	0000 0001b
Cause	A hardware problem was detected.
Effect	Device disabled Red LED "ON" Error bit set in Statusword
Error recovery	Reset device. If the problem persists, contact your supplier.

7.1.12. Hardware defect loading parameter error

Error code	0x5481
Error register	0000 0001b
Cause	Loading (restoring) persistent parameter failed due to hardware error. The parameters may have an inconsistent state.
Effect	Device disabled Red LED "ON" Error bit set in Statusword
Error recovery	Reset device. If the problem persists, contact your supplier.

7.1.13. Hardware configuration error

Error code	0x5482
Error register	0000 0001b
Cause	A hardware error occurred during configuration.
Effect	Device disabled Red LED "ON" Error bit set in Statusword
Error recovery	Reset device. If the problem persists, contact your supplier.

7.1.14. Hardware configuration error

Error code	0x5483
Error register	0000 0001b
Cause	A hardware error occurred during configuration.
Effect	Device disabled Red LED "ON" Error bit set in Statusword
Error recovery	Reset device. If the problem persists, contact your supplier.

7.1.15. Internal software error

Error code	0x6180
Error register	0000 0001b
Cause	Internal software error occurred.
Effect	Device disabled Red LED "ON" Error bit set in Statusword
Error recovery	Reset device. If the problem persists, contact your supplier.

7.1.16. Internal software error

Error code	0x6181
Error register	0000 0001b
Cause	Internal software error occurred.
Effect	Device disabled Red LED "ON" Error bit set in Statusword
Error recovery	Reset fault with Controlword . If the problem persists, contact your supplier.

7.1.17. Loading parameter failed error

Error code	0x6380
Error register	0000 0001b
Cause	Loading persistent parameter failed. The default values are restored.
Effect	Default parameters are set Device disabled Red LED "ON" Error bit set in Statusword
Error recovery	Reset fault with Controlword Set or load device parameters again

7.1.18. Loading parameter failed error

Error code	0x6381
Error register	0000 0001b
Cause	Loading persistent parameter failed. The default values are restored.
Effect	Default parameters are set Device disabled Red LED "ON" Error bit set in Statusword
Error recovery	Reset device If the problem persists, contact your supplier.

7.1.19. Loading parameter failed error

Error code	0x6382
Error register	0000 0001b
Cause	Loading persistent parameter failed. The default values are restored.
Effect	Default parameters are set Device disabled Red LED "ON" Error bit set in Statusword
Error recovery	Reset device If the problem persists, contact your supplier.

7.1.20. Torque constant parameter error

Error code	0x6388
Error register	0000 0001b
Cause	The open loop velocity control structure can be used only, if the torque constant is parameterized/tuned.

Effect	Device disabled Red LED "ON" Error bit set in Statusword
Error recovery	Configure the torque constant with the value in the datasheet. If a torque constant derived from tuning is desired, disable open loop velocity control structure and execute regulation tuning. Reset fault with Controlword

7.1.21. Current offset adjustment warning

Error code	0x7280
Error register	0000 0001b
Cause	During the current offset calibration an error occurred. This usually occurs if the motor is already turning upon enable.
Effect	Red LED "Slow" Warning bit set in Statusword
Error recovery	Auto clears after a successful current offset calibration. Ensure the motor is stationary when enabling.

7.1.22. Main sensor breach error

Error code	0x7380
Error register	0010 0001b
Cause	Sensor supervision has detected a bad working condition due to: - wrong/broken wiring of encoder - defective encoder - regulation parameters are not well tuned (see Current control parameter set)
Effect	Device disabled Red LED "ON" Error bit set in Statusword
Error recovery	Ensure Main Sensor is properly connected. Reset fault with Controlword

7.1.23. Hall sensor signal error

Error code	0x7388
Error register	0010 0001b
Cause	Either: incorrect wiring of Hall sensors, or incorrect wiring of Hall sensor supply voltage, or damaged Hall sensors, or big Hall sensor signal noise
Effect	Device disabled Red LED "ON" Error bit set in Statusword
Error recovery	Reset fault with Controlword

7.1.24. Hall angle detection error

Error code	0x738A
Error register	0010 0001b
Cause	Angle difference measured between the encoder and Hall sensors is too high due to: - wrong wiring of Hall sensors - defective Hall sensors - wrong wiring of encoder - defective encoder - wrong setting of encoder resolution or pole pairs
Effect	Device disabled Red LED "ON" Error bit set in Statusword
Error recovery	Check that the pole pair number setting is correct. Check sensor connections. Reset fault with Controlword

7.1.25. Missing main sensor error

Error code	0x7390
Error register	0010 0001b
Cause	No main sensor available.
Effect	Device disabled Red LED "ON" Error bit set in Statusword
Error recovery	Adapt settings in Axis configuration Reset fault with Controlword

7.1.26. Missing commutation sensor error

Error code	0x7391
Error register	0010 0001b
Cause	No commutation sensor available.
Effect	Device disabled Red LED "ON" Error bit set in Statusword
Error recovery	Adapt settings in Axis configuration Reset fault with Controlword

7.1.27. Main sensor direction error

Error code	0x7392
Error register	0010 0001b
Cause	Sensor supervision has detected a turn-away of the motor in the opposite direction due to: - wrong setting of sensor polarity - wrong sensor wiring - wrong motor wiring
Effect	Device disabled Red LED "ON" Error bit set in Statusword
Error recovery	Reset fault with Controlword

7.1.28. Negative limit switch error

Error code	0x8A80
Error register	0010 0001b
Cause	Negative limit switch was/is active or wrong configuration of limit switch function
Effect	Fault reaction is defined in the Fault reaction code.
Error recovery	Reset fault with Controlword

7.1.29. Positive limit switch error

Error code	0x8A81
Error register	0010 0001b
Cause	Positive limit switch was/is active or wrong configuration of limit switch function
Effect	Fault reaction is defined in the Fault reaction code.
Error recovery	Reset fault with Controlword

7.1.30. Digital input 1 PWM frequency warning

Error code	0x8A89
Error register	0000 0001b
Cause	PWM input 1 is configured in Configuration of digital inputs , the measured PWM frequency is outside the specified range.
Effect	The frequency of pwm input 1 in Digital input 1 PWM frequency is restricted to a range of 50 Hz to 10 kHz. Red LED "Slow" Warning bit set in Statusword
Error recovery	If the detected frequency is between 50 Hz and 10 kHz, the warning is cleared.

7.1.31. Digital input 1 PWM duty cycle warning

Error code	0x8A8A
Error register	0000 0001b
Cause	PWM input 1 is configured in Configuration of digital inputs , the measured PWM duty cycle is outside the specified range.
Effect	The duty cycle of pwm input 1 in Digital input 1 PWM duty cycle is restricted to a range of 10% and 90%. Red LED "Slow" Warning bit set in Statusword
Error recovery	If the detected duty cycle is between 10% and 90%, the warning is cleared.

7.1.32. Digital input 1 PWM error

Error code	0x8A8C
Error register	0000 0001b
Cause	PWM input 1 is configured in Configuration of digital inputs , the measured PWM signal is invalid. For details, see display values Digital input 1 PWM frequency and Digital input 1 PWM duty cycle .
Effect	Device disabled Red LED "ON" Error bit set in Statusword
Error recovery	Set PWM input into valid range. Reset fault with Controlword

7.1.33. Digital input 2 PWM frequency warning

Error code	0x8A8D
Error register	0000 0001b
Cause	PWM input 2 is configured in Configuration of digital inputs , the measured PWM frequency is outside the specified range.
Effect	The frequency of pwm input 2 in Digital input 2 PWM frequency is restricted to a range of 50 Hz to 10 kHz. Red LED "Slow" Warning bit set in Statusword
Error recovery	If the detected frequency is between 50 Hz and 10 kHz, the warning is cleared.

7.1.34. Digital input 2 PWM duty cycle warning

Error code	0x8A8E
Error register	0000 0001b
Cause	PWM input 2 is configured in Configuration of digital inputs , the measured PWM duty cycle is outside the specified range.

Effect	The duty cycle of pwm input 2 in Digital input 2 PWM duty cycle is restricted to a range of 10% and 90%. Red LED "Slow" Warning bit set in Statusword
Error recovery	If the detected duty cycle is between 10% and 90%, the warning is cleared.

7.1.35. Digital input 2 PWM error

Error code	0x8A90
Error register	0000 0001b
Cause	PWM input 2 is configured in Configuration of digital inputs , the measured PWM signal is invalid. For details, see display values Digital input 2 PWM frequency and Digital input 2 PWM duty cycle .
Effect	Device disabled Red LED "ON" Error bit set in Statusword
Error recovery	Set PWM input into valid range. Reset fault with Controlword

7.1.36. System overloaded warning

Error code	0xFF01
Error register	0000 0001b
Cause	The system load of the device has reached a critical value.
Effect	Red LED "Slow" Warning bit set in Statusword
Error recovery	Reset warning with Controlword (possible in every device state)

7.1.37. Watchdog error

Error code	0xFF02
Error register	0000 0001b
Cause	Device reset by watchdog due to fatal system overload or system fault.
Effect	Device disabled Red LED "ON" Error bit set in Statusword
Error recovery	Reset fault with Controlword

7.1.38. Watchdog error

Error code	0xFF03
Error register	0000 0001b
Cause	Device reset by watchdog due to fatal system overload or system fault.
Effect	Device disabled Red LED "ON" Error bit set in Statusword
Error recovery	Reset fault with Controlword

7.1.39. System peak overloaded error

Error code	0xFF06
Error register	0000 0001b
Cause	The device has not enough free resources to provide proper regulation.

Effect	Device disabled Red LED "ON" Error bit set in Statusword
Error recovery	Reset fault with Controlword

7.1.40. System peak overloaded error

Error code	0xFF07
Error register	0000 0001b
Cause	The device has not enough free resources to provide proper regulation.
Effect	Device disabled Red LED "ON" Error bit set in Statusword
Error recovery	Reset fault with Controlword

7.1.41. Mode of operation not supported error

Error code	0xFF0D
Error register	0000 0001b
Cause	The requested mode of operation is not supported with the configured control structure.
Effect	Device disabled Red LED "ON" Error bit set in Statusword
Error recovery	Change either the mode of operation or the control structure. Reset fault with Controlword

7.1.42. Regulation tuning identification error

Error code	0xFF11
Error register	0010 0001b
Cause	An error occurred during regulation tuning identification.
Effect	Device disabled Red LED "ON" Error bit set in Statusword
Error recovery	Reset fault with Controlword

7.1.43. Regulation tuning current error

Error code	0xFF12
Error register	0010 0001b
Cause	Required current could not be reached during regulation tuning.
Effect	Device disabled Red LED "ON" Error bit set in Statusword
Error recovery	Increase Nominal current and/or Output current limit (make sure not to exceed the maximum values of the motor specification). Reset fault with Controlword

7.1.44. Regulation tuning identification current error

Error code	0xFF13
Error register	0010 0001b

Cause	Identification current could not be reached during regulation tuning identification.
Effect	Device disabled Red LED "ON" Error bit set in Statusword
Error recovery	Increase Nominal current and/or Output current limit (make sure not to exceed the maximum values of the motor specification). Reset fault with Controlword

7.1.45. Regulation tuning unrealistic result error

Error code	0xFF14
Error register	0010 0001b
Cause	The resulting resistance or inductance value is unrealistic.
Effect	Device disabled Red LED "ON" Error bit set in Statusword
Error recovery	Check the motor parameters in Motor data . Reset fault with Controlword Run tuning again.

7.1.46. Regulation tuning identification error

Error code	0xFF15
Error register	0010 0001b
Cause	An error occurred during regulation tuning identification.
Effect	Device disabled Red LED "ON" Error bit set in Statusword
Error recovery	Reset fault with Controlword

7.1.47. Regulation tuning identification error

Error code	0xFF16
Error register	0010 0001b
Cause	An error occurred during regulation tuning identification.
Effect	Device disabled Red LED "ON" Error bit set in Statusword
Error recovery	Check the motor parameters in Motor data . Reset fault with Controlword Run all tuning again.

7.1.48. Regulation tuning identification error

Error code	0xFF17
Error register	0010 0001b
Cause	An error occurred during regulation tuning identification.
Effect	Device disabled Red LED "ON" Error bit set in Statusword
Error recovery	Reset fault with Controlword . Run tuning again.

7.1.49. Regulation tuning identification error

Error code	0xFF19
Error register	0010 0001b

Cause	An error occurred during regulation tuning identification.
Effect	Device disabled Red LED "ON" Error bit set in Statusword
Error recovery	Reset fault with Controlword Run tuning again.

7.1.50. Regulation tuning standstill error

Error code	0xFF20
Error register	0010 0001b
Cause	Regulation tuning identification motor not in standstill, please ensure that the motor is not moving when starting tuning process.
Effect	Device disabled Red LED "ON" Error bit set in Statusword
Error recovery	Make sure the motor is at standstill when starting tuning. Reset fault with Controlword Run tuning again.

7.1.51. Regulation tuning torque constant error

Error code	0xFF21
Error register	0010 0001b
Cause	Regulation tuning identification motor torque value invalid, please ensure that the motor movement is not being obstructed during tuning process.
Effect	Device disabled Red LED "ON" Error bit set in Statusword
Error recovery	Ensure the motor movement is not being obstructed. Reset fault with Controlword Run tuning again.

7.1.52. Regulation tuning max system speed error

Error code	0xFF22
Error register	0010 0001b
Cause	Max system speed exceeded during Regulation tuning identification, reduce step amplitude to reduce max speed
Effect	Device disabled Red LED "ON" Error bit set in Statusword
Error recovery	Increase max motor speed. Reset fault with Controlword Run tuning again.

7.1.53. Regulation tuning motor connection error

Error code	0xFF23
Error register	0010 0001b
Cause	Identification current is very small. Check the motor connection.
Effect	Device disabled Red LED "ON" Error bit set in Statusword
Error recovery	Reset fault with Controlword

7.1.54. Regulation tuning sensor signal error

Error code	0xFF24
------------	--------

Error register	0010 0001b
Cause	Sensor signal was not found during tuning identification, check the sensor or motor connection
Effect	Device disabled Red LED "ON" Error bit set in Statusword
Error recovery	Check sensor connection. Reset fault with Controlword Run tuning again.

7.2. Communication Errors (Abort Codes)

The abort codes will be sent as part of the response to any interface request (e.g. USB).

The following abort codes are defined by CANopen Communication Profile CiA 301. Codes above 0x0F00'0000 are maxon-specific.

Abort code	Name	cause
0x0000 0000	No abort	Communication successful
0x0503 0000	Toggle error	Toggle bit not alternated
0x0504 0001	Command unknown	Command specifier unknown
0x0504 0004	CRC error	CRC check failed
0x0601 0000	Access error	Unsupported access to an object
0x0601 0001	Write only error	Read command to a write only object
0x0601 0002	Read only error	Write command to a read only object
0x0601 0003	Subindex cannot be written	Subindex cannot be written, subindex 0 must be "0" (zero) for write access
0x0602 0000	Object does not exist error	Last read or write command had wrong object index or subindex
0x0604 0043	General parameter error	General parameter incompatibility
0x0604 0047	General internal incompatibility error	General internal incompatibility in device
0x0606 0000	Hardware error	Access failed due to hardware error
0x0607 0010	Service parameter error	Data type does not match, length or service parameter do not match
0x0607 0012	Service parameter too high error	Data type does not match, length of service parameter too high
0x0607 0013	Service parameter too low error	Data type does not match, length of service parameter too low
0x0609 0011	Subindex error	Last read or write command had wrong object subindex
0x0609 0030	Value range error	Value range of parameter exceeded
0x0800 0000	General error	General error
0x0800 0020	Transfer or store error	Data cannot be transferred or stored
0x0800 0022	Wrong device state error	Data cannot be transferred or stored to application because of present device state
0x0F00 FFC1	Segmented transfer expected	Unsupported access to an object, segmented access is expected

Table 111. CANopen abort codes

8. Firmware version history

8.1. Version overview

Date [yyyy- mm]	Version		Application		Firmware Specification DocID	Description
	Software	Hardware	#	Version		
2024-03	0100h	1101h, 1102h, 1103h	1000h	0000h	rel12245	Initial release

Table 112. Version overview