

# EPOS4

## Firmware Specification



[epos.maxongroup.com](https://epos.maxongroup.com)

## TABLE OF CONTENTS

<b>1</b>	<b>ABOUT</b>	<b>9</b>
1.1	About this Document . . . . .	9
1.2	About the Devices . . . . .	13
1.3	About the Safety Precautions . . . . .	13
<b>2</b>	<b>SYSTEM OVERVIEW</b>	<b>15</b>
2.1	Device Architecture . . . . .	15
2.2	Device Control . . . . .	16
2.3	System Units . . . . .	19
2.4	USB Bus Powering . . . . .	20
<b>3</b>	<b>OPERATING MODES</b>	<b>21</b>
3.1	Operating Mode Selection Guide . . . . .	21
3.2	Overview . . . . .	22
3.3	Profile Position Mode (PPM) . . . . .	23
3.4	Profile Velocity Mode (PVM) . . . . .	27
3.5	Homing Mode (HMM) . . . . .	30
3.6	Cyclic Synchronous Position Mode (CSP) . . . . .	39
3.7	Cyclic Synchronous Velocity Mode (CSV) . . . . .	43
3.8	Cyclic Synchronous Torque Mode (CST) . . . . .	46
3.9	Position Control Function . . . . .	49
3.10	Velocity Control Function . . . . .	51
3.11	Current Control Function . . . . .	53

### READ THIS FIRST

***These instructions are intended for qualified technical personnel. Prior commencing with any activities...***

- you must carefully read and understand this manual and
- you must follow the instructions given therein.

***EPOS4 positioning controllers are considered as partly completed machinery according to EU Directive 2006/42/EC, Article 2, Clause (g) and are intended to be incorporated into or assembled with other machinery or other partly completed machinery or equipment.***

***Therefore, you must not put the device into service,...***

- unless you have made completely sure that the other machinery fully complies with the EU directive's requirements!
- unless the other machinery fulfills all relevant health and safety aspects!
- unless all respective interfaces have been established and fulfill the herein stated requirements!

<b>4</b>	<b>INPUTS AND OUTPUTS</b>	<b>57</b>
4.1	Digital Inputs	57
4.2	Digital Outputs	59
4.3	Analog Inputs	60
4.4	Analog Outputs	61
<b>5</b>	<b>COMMUNICATION</b>	<b>63</b>
5.1	USB & RS232 Communication	63
5.2	CAN Communication	63
5.3	EtherCAT Communication	63
5.4	Gateway Communication (USB/RS232 to CAN)	64
<b>6</b>	<b>OBJECT DICTIONARY</b>	<b>65</b>
6.1	Overview	65
6.1.1	Object Data Types	65
6.1.2	Object Codes	65
6.1.3	Object Access Types	65
6.1.4	Object Flags	66
6.1.5	Entries Overview	66
6.2	Objects	70
6.2.1	Device type	70
6.2.2	Error register	70
6.2.3	Error history	71
6.2.4	COB-ID SYNC	72
6.2.5	Manufacturer device name	73
6.2.6	Store parameters	74
6.2.7	Restore default parameters	75
6.2.8	COB-ID EMCY	75
6.2.9	Consumer heartbeat time	76
6.2.10	Producer heartbeat time	77
6.2.11	Identity object	77
6.2.12	Error behavior	80
6.2.13	Diagnosis History	81
6.2.14	SDO server parameter	85
6.2.15	Receive PDO 1 parameter	86
6.2.16	Receive PDO 2 parameter	88
6.2.17	Receive PDO 3 parameter	89
6.2.18	Receive PDO 4 parameter	90
6.2.19	Receive PDO 1 mapping	91
6.2.20	Receive PDO 2 mapping	93
6.2.21	Receive PDO 3 mapping	94
6.2.22	Receive PDO 4 mapping	96
6.2.23	Transmit PDO 1 parameter	97
6.2.24	Transmit PDO 2 parameter	99
6.2.25	Transmit PDO 3 parameter	101

6.2.26	Transmit PDO 4 parameter	102
6.2.27	Transmit PDO 1 mapping	104
6.2.28	Transmit PDO 2 mapping	106
6.2.29	Transmit PDO 3 mapping	107
6.2.30	Transmit PDO 4 mapping	109
6.2.31	SYNC manager communication type	110
6.2.32	SYNC manager 2 PDO assignment	112
6.2.33	SYNC manager 3 PDO assignment	113
6.2.34	SYNC manager 2 parameter	114
6.2.35	SYNC manager 3 parameter	118
6.2.36	Program data	121
6.2.37	Program control	122
6.2.38	Program software identification	123
6.2.39	Flash status identification	124
6.2.40	Node-ID	126
6.2.41	CAN bit rate	127
6.2.42	RS232 bit rate	128
6.2.43	RS232 frame timeout	129
6.2.44	USB frame timeout	129
6.2.45	CAN bit rate display	130
6.2.46	Active fieldbus	130
6.2.47	Additional identity	131
6.2.48	Extension 1 identity	131
6.2.49	Custom persistent memory	134
6.2.50	Power supply	134
6.2.51	Power supply supervision	135
6.2.52	Axis configuration	138
6.2.53	Motor data	150
6.2.54	Electrical system parameters	153
6.2.55	Gear configuration	154
6.2.56	Digital incremental encoder 1	156
6.2.57	Analog incremental encoder	158
6.2.58	SSI absolute encoder	160
6.2.59	Digital Hall sensor	168
6.2.60	Digital incremental encoder 2	170
6.2.61	Current control parameter set	172
6.2.62	Position control parameter set	173
6.2.63	Velocity control parameter set	176
6.2.64	Velocity observer parameter set	178
6.2.65	Dual loop position control parameter set	180
6.2.66	Home position	186
6.2.67	Home offset move distance	187
6.2.68	Current threshold for homing mode	187
6.2.69	Current demand value	187
6.2.70	Current actual values	188
6.2.71	Torque actual values	189
6.2.72	Velocity actual values	190



6.2.73	Standstill window configuration	191
6.2.74	Digital input properties	193
6.2.75	Configuration of digital inputs	195
6.2.76	Digital output properties	197
6.2.77	Configuration of digital outputs	198
6.2.78	Holding brake parameters	200
6.2.79	Analog input properties	203
6.2.80	Configuration of analog inputs	204
6.2.81	Analog input general purpose	205
6.2.82	Analog input adjustment	206
6.2.83	Analog input current set value properties	207
6.2.84	Analog input velocity set value properties	210
6.2.85	Analog output properties	212
6.2.86	Configuration of analog outputs	213
6.2.87	Analog output general purpose	214
6.2.88	Power limitation	215
6.2.89	Thermal overload protection	216
6.2.90	Functional safety	218
6.2.91	Motor control	219
6.2.92	Abort connection option code	219
6.2.93	Error code	220
6.2.94	Controlword	221
6.2.95	Statusword	222
6.2.96	Quick stop option code	223
6.2.97	Shutdown option code	224
6.2.98	Disable operation option code	224
6.2.99	Fault reaction option code	225
6.2.100	Modes of operation	226
6.2.101	Modes of operation display	226
6.2.102	Position demand value	227
6.2.103	Position actual value	227
6.2.104	Following error window	227
6.2.105	Following error time out	228
6.2.106	Position window	229
6.2.107	Position window time	230
6.2.108	Velocity demand value	230
6.2.109	Velocity actual value	230
6.2.110	Target torque	231
6.2.111	Motor rated torque	231
6.2.112	Torque actual value	231
6.2.113	Target position	232
6.2.114	Position range limit	233
6.2.115	Software position limit	234
6.2.116	Max profile velocity	235
6.2.117	Max motor speed	235
6.2.118	Profile velocity	236
6.2.119	Profile acceleration	236

6.2.120	Profile deceleration	236
6.2.121	Quick stop deceleration	237
6.2.122	Motion profile type	237
6.2.123	Homing method	238
6.2.124	Homing speeds	239
6.2.125	Homing acceleration	240
6.2.126	SI unit position	240
6.2.127	SI unit velocity	241
6.2.128	SI unit acceleration	242
6.2.129	Position offset	242
6.2.130	Velocity offset	243
6.2.131	Torque offset	243
6.2.132	Touch probe function	244
6.2.133	Touch probe status	245
6.2.134	Touch probe 1 positive edge	245
6.2.135	Touch probe 1 negative edge	246
6.2.136	Interpolation time period	247
6.2.137	Max acceleration	248
6.2.138	Touch probe source	249
6.2.139	Touch probe 1 positive edge counter	250
6.2.140	Touch probe 1 negative edge counter	250
6.2.141	Supported homing methods	251
6.2.142	Additional position actual values	256
6.2.143	Additional velocity actual values	258
6.2.144	Following error actual value	260
6.2.145	Digital inputs	261
6.2.146	Digital outputs	262
6.2.147	Target velocity	263
6.2.148	Motor type	263
6.2.149	Supported drive modes	264
6.2.150	Modular device profile	265
6.2.151	Configured module ident list	266
6.2.152	Detected module ident list	267
6.3	<b>Modular Device Profile Module</b>	<b>268</b>
6.3.1	MDP Module PPM	268
6.3.2	MDP Module PVM	269
6.3.3	MDP Module CSP	270
6.3.4	MDP Module CSV	271
6.3.5	MDP Module CST	272
<b>7</b>	<b>ERROR HANDLING</b>	<b>273</b>
7.1	Emergency Message Frame	273
7.2	Device Errors	273
7.3	CANopen Communication Errors (Abort Codes)	292
7.4	EtherCAT FoE Error Codes	293

<b>8</b>	<b>FIRMWARE VERSION HISTORY</b>	<b>295</b>
8.1	Version Overview.....	295
8.2	Version History .....	296
	<b>LIST OF FIGURES</b>	<b>307</b>
	<b>LIST OF TABLES</b>	<b>309</b>
	<b>INDEX</b>	<b>315</b>

**••page intentionally left blank••**

# 1 ABOUT

## 1.1 About this Document

### 1.1.1 Intended Purpose

The purpose of the present document is to familiarize you with the described equipment and the tasks on safe and adequate installation and/or commissioning. Follow the described instructions ...

- to avoid dangerous situations,
- to keep installation and/or commissioning time at a minimum,
- to increase reliability and service life of the described equipment.

The present document is part of a documentation set and provides EPOS4 firmware details and contains descriptions on architecture, device states, operation modes, error handling, and object dictionary. The below overview shows the documentation hierarchy and the interrelationship of its individual parts:

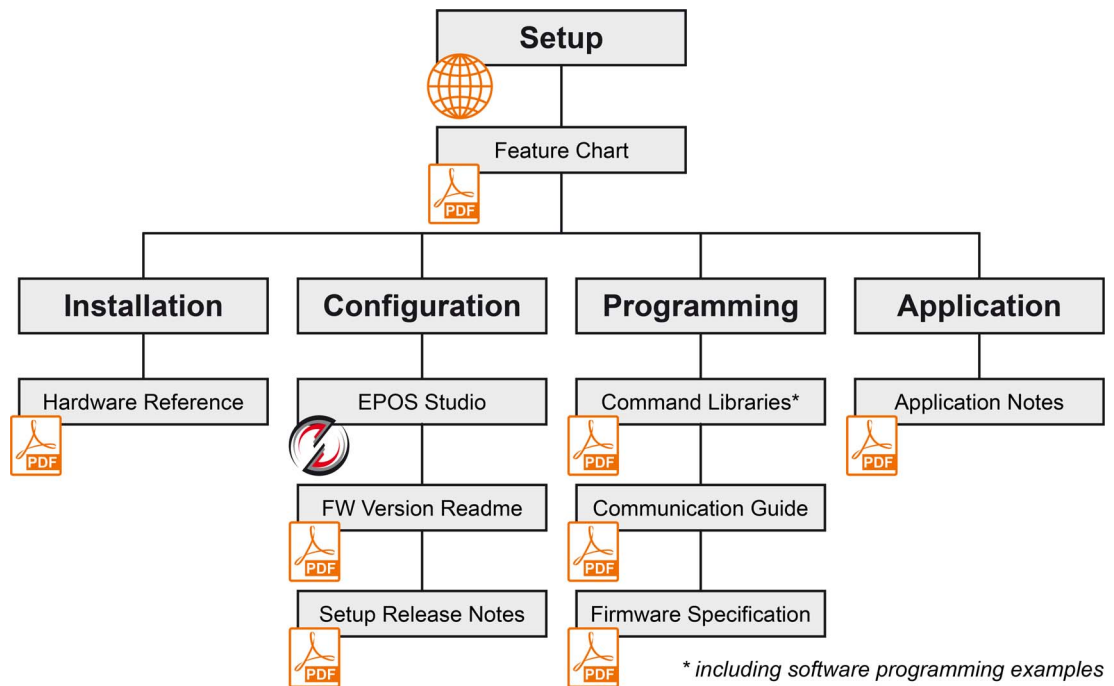

Figure 1-1 Documentation structure

Find the latest edition of the present document as well as additional documentation and software for EPOS4 positioning controllers also on the Internet: →<http://epos.maxongroup.com>

### 1.1.2 Target Audience

This document is meant for trained and skilled personnel working with the equipment described. It conveys information on how to understand and fulfill the respective work and duties.

This document is a reference book. It does require particular knowledge and expertise specific to the equipment described.

### 1.1.3 How to use

Take note of the following notations and codes which will be used throughout the document.

Notation	Explanation
<b>EPOS</b>	stands for all supported positioning controller types of the EPOS family (EPOS, EPOS2, and EPOS4)
<b>EPOS2</b>	stands for “EPOS2 positioning controller”
<b>EPOS4</b>	stands for “EPOS4 positioning controller”
<b>EPOS4 Disk 60/8</b>	stands for all EPOS4 Disk 60/8 versions, both CANopen and EtherCAT
<b>EPOS4 Disk 60/12</b>	stands for all EPOS4 Disk 60/12 versions, both CANopen and EtherCAT
<b>EPOS4 Micro 24/5</b>	stands for all EPOS4 Micro 24/5 versions, both CANopen and EtherCAT
<b>«Abcd»</b>	indicating a title or a name (such as of document, product, mode, etc.)
<b>(n)</b>	referring to an item (such as order number, list item, etc.)
<b>*</b>	referring to an internal value
<b>→</b>	denotes “see”, “see also”, “take note of”, or “go to”

Table 1-1 Notations used

In the later course of the present document, the following abbreviations and acronyms will be used:

Short	Description
<b>CCW</b>	Counterclockwise
<b>CiA</b>	CAN in Automation
<b>CSP</b>	Cyclic Synchronous Position Mode
<b>CST</b>	Cyclic Synchronous Torque Mode
<b>CSV</b>	Cyclic Synchronous Velocity Mode
<b>CW</b>	Clockwise
<b>EDS</b>	Electronic Data Sheet
<b>GPIO</b>	General purpose input/output
<b>HMM</b>	Homing Mode
<b>NMT</b>	Network Management
<b>OBD</b>	Object Dictionary
<b>PDO</b>	Process Data Object
<b>PPM</b>	Profile Position Mode
<b>PVM</b>	Profile Velocity Mode
<b>SDO</b>	Service Data Object

Table 1-2 Abbreviations & acronyms used

### 1.1.4 Symbols and Signs



#### **Requirement / Note / Remark**

*Indicates an action you must perform prior continuing or refers to information on a particular item.*



#### **Best Practice**

*Gives advice on the easiest and best way to proceed.*



#### **Material Damage**

*Points out information particular to potential damage of equipment.*

### 1.1.5 Trademarks and Brand Names

For easier legibility, registered brand names are listed below and will not be further tagged with their respective trademark. It must be understood that the brands (the below list is not necessarily concluding) are protected by copyright and/or other intellectual property rights even if their legal trademarks are omitted in the later course of this document.

Brand name	Trademark owner
Adobe® Reader®	© Adobe Systems Incorporated, USA-San Jose, CA
BiSS	© iC-Haus GmbH, DE-Bodenheim
CANopen® CiA®	© CiA CAN in Automation e.V, DE-Nuremberg
EnDat	© DR. JOHANNES HEIDENHAIN GmbH, DE-Traunreut
EtherCAT®	© EtherCAT Technology Group, DE-Nuremberg, licensed by Beckhoff Automation GmbH, DE-Verl

Table 1-3 Brand names and trademark owners

### 1.1.6 Sources for additional Information

For further details and additional information, please refer to below listed sources:

#	Reference
[1]	USB Implementers Forum: Universal Serial Bus Revision 2.0 Specification <a href="http://www.usb.org/developers/docs">www.usb.org/developers/docs</a>
[2]	CiA 301 CANopen application layer and communication profile <a href="http://www.can-cia.org">www.can-cia.org</a>
[3]	CiA 305 Layer Setting Services (LSS) and protocols <a href="http://www.can-cia.org">www.can-cia.org</a>
[4]	CiA 306 CANopen electronic data sheet specification <a href="http://www.can-cia.org">www.can-cia.org</a>
[5]	CiA 402 CANopen device profile for drives and motion control <a href="http://www.can-cia.org">www.can-cia.org</a>
[6]	Bosch's CAN Specification 2.0 <a href="http://www.can-cia.org">www.can-cia.org</a>
[7]	Konrad Etschberger: Controller Area Network ISBN 3-446-21776-2
[8]	maxon: EPOS4 Communication Guide <a href="http://www.maxongroup.com">www.maxongroup.com</a>
[9]	maxon: EPOS4 Application Notes <a href="http://www.maxongroup.com">www.maxongroup.com</a>
[10]	IEC 61158-x-12: Industrial communication networks – Fieldbus specifications (CPF 12)
[11]	IEC 61800-7: Adjustable speed electrical power drives systems (Profile type 1)
[12]	ETG.1000 EtherCAT Specification <a href="http://www.ethercat.org">www.ethercat.org</a>
[13]	ETG.1020 EtherCAT Protocol Enhancements Specification <a href="http://www.ethercat.org">www.ethercat.org</a>
[14]	ETG.2000 EtherCAT Slave Information (ESI) Specification <a href="http://www.ethercat.org">www.ethercat.org</a>
[14]	EN 5325-4 Industrial communications subsystem based on ISO 11898 (CAN) for controller device interfaces Part4: CANopen

Table 1-4 Sources for additional information

### 1.1.7 Copyright

This document is protected by copyright. Any further use (including reproduction, translation, microfilming, and other means of electronic data processing) without prior written approval is not permitted. The mentioned trademarks belong to their respective owners and are protected under intellectual property rights. © 2022 maxon. All rights reserved. Subject to change without prior notice.

CCMC | EPOS4 Firmware Specification | Edition 2022-04 | DocID rel10503

maxon motor ag  
Brünigstrasse 220 +41 41 666 15 00  
CH-6072 Sachseln [www.maxongroup.com](http://www.maxongroup.com)



## 1.2 About the Devices

maxon's EPOS4 positioning controllers are small-sized, full digital, smart positioning control units. Their high power density allow flexible use for brushed DC and brushless EC (BLDC) motors with various feedback options, such as Hall sensors, incremental encoders as well as absolute sensors in a multitude of drive applications.

## 1.3 About the Safety Precautions

### IMPORTANT NOTICE: PREREQUISITES FOR PERMISSION TO COMMENCE INSTALLATION

**EPOS4 positioning controllers** are considered as partly completed machinery according to EU Directive 2006/42/EC, Article 2, Clause (g) and **are intended to be incorporated into or assembled with other machinery or other partly completed machinery or equipment.**



#### WARNING

##### ***Risk of Injury***

***Operating the device without the full compliance of the surrounding system with the EU directive 2006/42/EC may cause serious injuries!***

- *Do not operate the device, unless you have made sure that the other machinery fulfills the requirements stated in EU directive!*
- *Do not operate the device, unless the surrounding system fulfills all relevant health and safety aspects!*
- *Do not operate the device, unless all respective interfaces have been established and fulfill the stated requirements!*

••page intentionally left blank••

## 2 SYSTEM OVERVIEW

### 2.1 Device Architecture

The EPOS4's communication interface follows these specifications (numbers in brackets refer to respective items listed on →page 1-12):

- CiA 301 V4.2; CANopen application layer and communication profile (→[2]), corresponds with the international standard EN 5325-4; Industrial communications subsystem based on ISO 11898 (CAN) (→[14])
- CiA 306 V1.3; CANopen electronic data sheet specification (→[4])
- CiA 402 V4.0; CANopen device profile for drives and motion control (→[5]), corresponds with international standard IEC 61800-7 Ed 2.0; Generic interface and use of profiles for power drive systems – profile type 1 (→[11])
- ETG.1000 V1.0.4; EtherCAT Specification (→[12]), corresponds with the international standard IEC 61158-x-12; Industrial communication networks – Fieldbus specifications (CPF 12: EtherCAT) (→[10])
- ETG.1020 V1.2.0; EtherCAT Protocol Enhancements Specification (→[13])
- ETG.2000 V1.0.9; EtherCAT Slave Information (ESI) Specification (→[14])

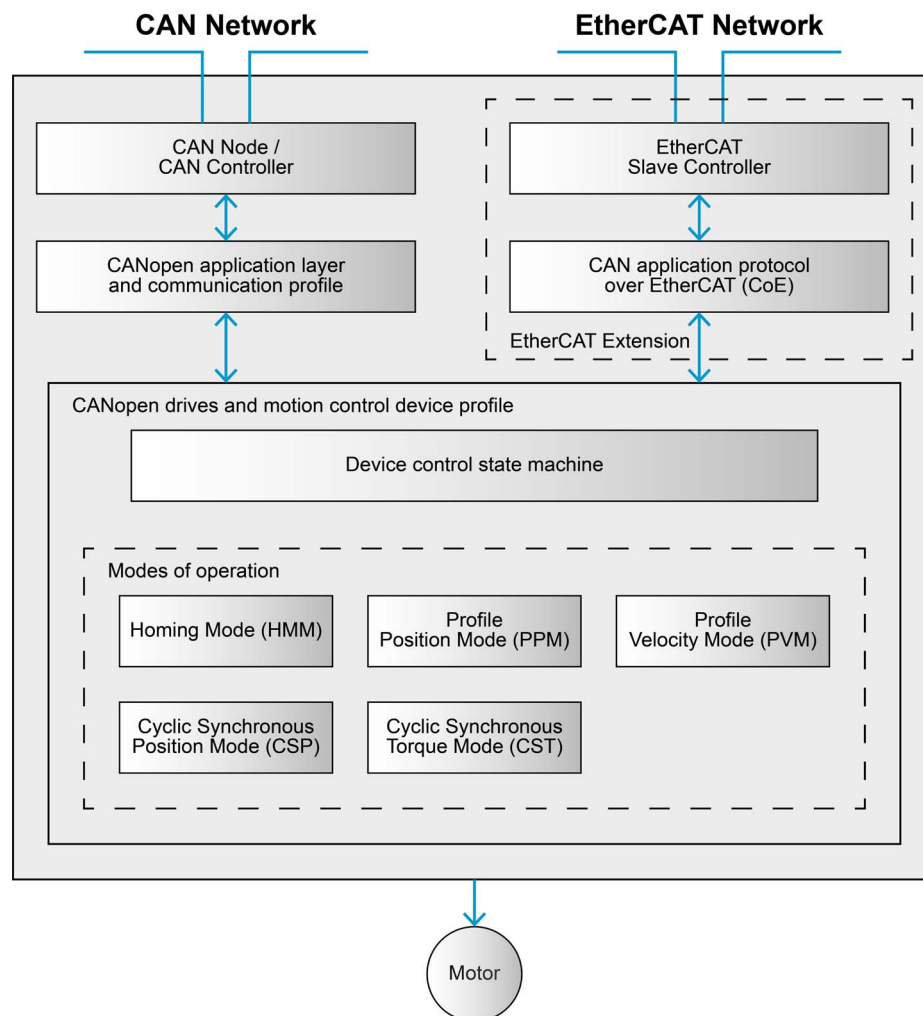

Figure 2-2 Communication architecture

**DEVICE CONTROL**

Starting and stopping of the drive and several mode-specific commands are executed by the state machine.

**MODES OF OPERATION**

The operating mode defines the behavior of the drive.

**2.2 Device Control**

The state machine describes the axis state and the possible control sequence of the axis. An axis state represents a special internal or external behavior. The state of the axis also determines the commands that will be accepted.

States may be changed using the →Controlword and/or according to internal events. The actual state can be read using the →Statusword. A new state transition must not be initiated before the previous one is completed and the →Statusword is changed accordingly.

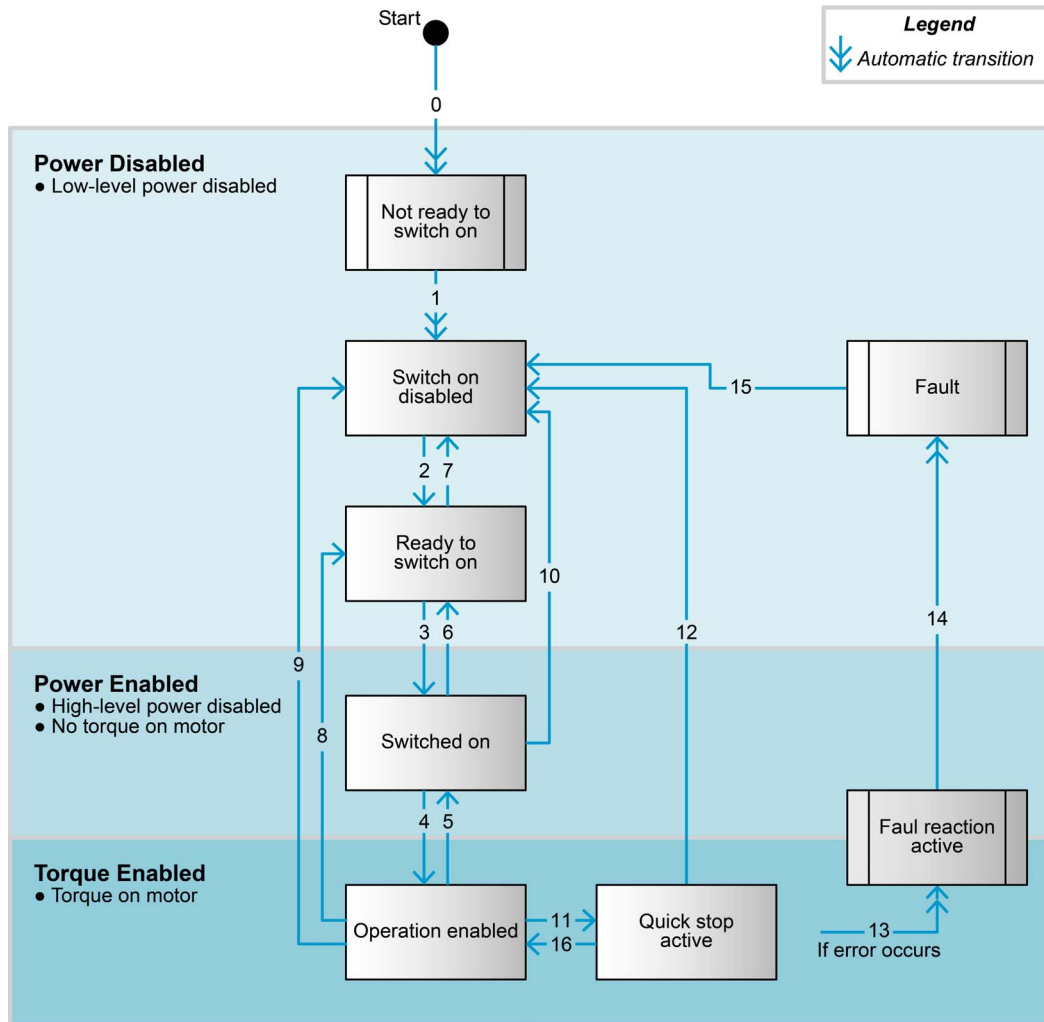

Figure 2-3 Device State Machine

## 2.2.1 State of the Drive

The following →Statusword bits indicate the actual state of the drive.

State	Statusword [binary]	Description
Not ready to switch on	xxxx xxxx x00x 0000	Drive function is disabled
Switch on disabled	xxxx xxxx x10x 0000	Drive initialization is complete. Drive parameters may be changed. Drive function is disabled.
Ready to switch on	xxxx xxxx x01x 0001	Drive parameters may be changed. Drive function is disabled.
Switched on	xxxx xxxx x01x 0011	Drive function is disabled. Current offset calibration done.
Operation enabled	xxxx xxxx x01x 0111	No faults have been detected. Drive function is enabled and power is applied to the motor.
Quick stop active	xxxx xxxx x00x 0111	«Quick stop» function is being executed. Drive function is enabled and power is applied to the motor.
Fault reaction active	xxxx xxxx x00x 1111	A fault has occurred in the drive. Selected fault reaction is being executed.
Fault	xxxx xxxx x00x 1000	A fault has occurred in the drive. Drive parameters may have changed. Drive function is disabled.

Table 2-5 Device state bits

## 2.2.2 State Transitions

State transitions are caused by internal events in the drive or by commands from the host via the →Controlword.



### State transition during change of state

*If a command is received which causes a change of state, this command will be processed completely and the new state attained before the next command can be processed.*

Transition	Event	Action
0	Reset	Initialize drive
1	Drive has initialized successfully	Activate communication
2	«Shutdown» command received	
3	«Switched on» command received	Initialize current sensor. Current offset calibration.
4	«Enable operation» command received	Enable drive function (enable current controller and, if needed, position or velocity controller)
5	«Disable operation» command received	Stop movement according to «Disable operation option code». Disable drive function.
6	«Shutdown» command received	Disable power section
7	«Quick stop» or «Disable voltage» command received	

Continued on next page.

Transition	Event	Action
8	«Shutdown» command received	Stop movement according to «Shutdown option code». Disable drive function and power section.
9	«Disable voltage» command received	Stop movement according to «Shutdown option code». Disable drive function and power section.
10	«Quick stop» or «Disable voltage» command received	
11	«Quick stop» command received	Stop movement according to «Quick stop option code»
12	«Disable voltage» command received	Disable drive function and power section
13	A fault has occurred	Start fault reaction
14	The fault reaction is completed	Disable drive function and power section
15	«Fault reset» command received	Reset fault condition if no fault is present
16	«Enable operation» command received	

Table 2-6 Device state transitions

### 2.2.3 Device Control Commands

Axis control commands are triggered by the following bit patterns in the →Controlword.

Command	Controlword LowByte [binary]	State transition
Shutdown	0xxx x110	2, 6, 8
Switch on	0xxx x111	3
Switch on & Enable operation	0xxx 1111	3, 4 (*1)
Disable voltage	0xxx xx0x	7, 9, 10, 12
Quick stop	0xxx x01x	11
Disable operation	0xxx 0111	5
Enable operation	0xxx 1111	4, 16
Fault reset	0xxx xxxx → 1xxx xxxx	14, 15

(\*1) Automatic transition to state «Operation enabled» after execution of command «Switch on»

Table 2-7 Axis control commands

## 2.3 System Units

The user-defined units for this device are as follows:

- Position Units (→“SI unit position” on page 6-240)
- Velocity Units (→“SI unit velocity” on page 6-241)
- Acceleration Units (→“SI unit acceleration” on page 6-242)

The units are used for all objects that support user-defined units. They are specified by the SI unit objects. Objects with factor group-independent values have fixed units specified by the object.

Coding of user-defined units and prefixes takes place as to →Table 2-8.

Bit 31...24	Bit 23...16	Bit 15...8	Bit 7...0
Prefix	Numerator	Denominator	reserved (0)

Table 2-8 User-defined units – Parameter structure

### 2.3.1 SI Units

Description	Name	Symbol	Notation index
Dimensionless	–	–	0x00
Length	Meter	m	0x01
Mass	Kilogram	kg	0x02
Time	Second	s	0x03
Electric current	Ampere	A	0x04
Time	Minute	min	0x47
Square second	Square second	s <sup>2</sup>	0x57

Table 2-9 SI units – Notation index

### 2.3.2 CiA 402 Application Profile-specific Units

Description	Name	Symbol	Notation index
Revolutions	revolutions	rev	0xB4
Increments	increments	inc	0xB5
Steps	steps	steps	0xAC
Velocity (manufacturer-specific)	revolutions/minute	rpm	0xC0

Table 2-10 CiA 402 Application profile-specific units – Notation index

### 2.3.3 Unit Prefixes

Prefix	Factor	Symbol	Notation index
Mega	$10^6$	M	0x06
Kilo	$10^3$	k	0x03
Hecta	$10^2$	h	0x02
Deca	$10^1$	da	0x01
–	$10^0$	–	0x00
Deci	$10^{-1}$	d	0xFF
Centi	$10^{-2}$	c	0xFE
Milli	$10^{-3}$	m	0xFD
—	$10^{-4}$	—	0xFC
—	$10^{-5}$	—	0xFB
Micro	$10^{-6}$	μ	0xFA

Table 2-11 Unit prefixes – Notation index

## 2.4 USB Bus Powering

Powering the controller for configuration via USB only is not possible. To use a communication interface, either the power supply or the logic supply must be connected.



### 3 OPERATING MODES

#### 3.1 Operating Mode Selection Guide

The device behavior depends on the currently activated mode of operation.

- Choose desired mode (→“Overview” on page 3-22).
- Select mode using (→“Modes of operation” on page 6-226).
- Read currently active mode from →“Modes of operation display” on page 6-226.

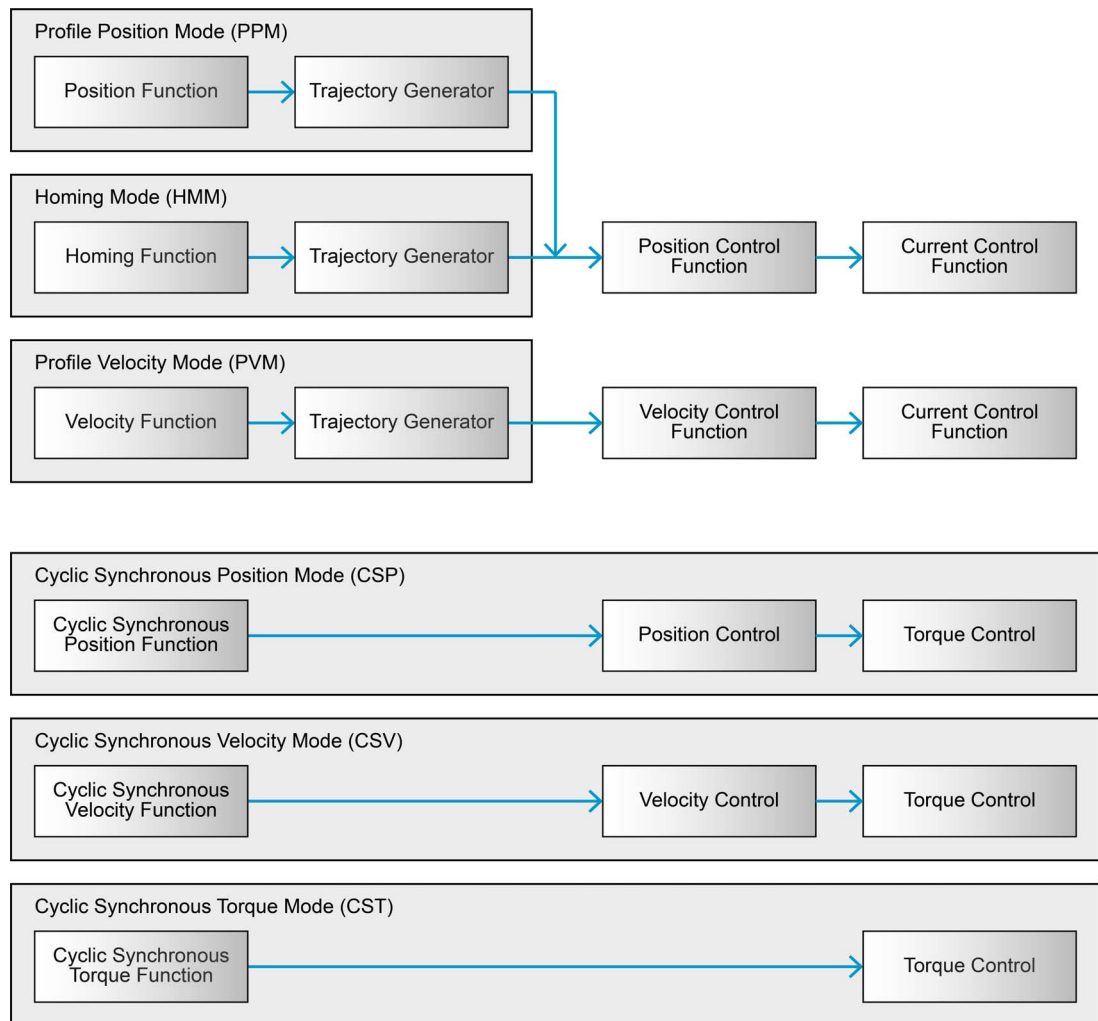

Figure 3-4 Functional architecture

## 3.2 Overview

### **PROFILE POSITION MODE (PPM)**

Defines the drive's positioning. Speed, position, and acceleration can be limited, profiled moves can be executed using a Trajectory Generator. For details see →page 3-23.

### **PROFILE VELOCITY MODE (PVM)**

Controls the drive's velocity without particular focus on the position. It supplies limit functions and Trajectory Generation. For details see →page 3-27.

### **HOMING MODE (HMM)**

Provides various methods to find the home position (also called reference point or zero point). For details see →page 3-30.

### **CYCLIC SYNCHRONOUS POSITION MODE (CSP)**

The trajectory generator is located in the control device (not in the drive device). In cyclic synchronous manner, it provides a target position to the drive device, which then performs position control, velocity control, and torque control. For details see →page 3-39

### **CYCLIC SYNCHRONOUS VELOCITY MODE (CSV)**

The trajectory generator is located in the control device (not in the drive device). In cyclic synchronous manner, it provides a target velocity to the drive device, which then performs velocity control and torque control. For details see →page 3-43

### **CYCLIC SYNCHRONOUS TORQUE MODE (CST)**

The trajectory generator is located in the control device (not in the drive device). In cyclic synchronous manner, it provides a target torque to the drive device, which then performs torque control. For details see →page 3-46.

### 3.3 Profile Position Mode (PPM)

A target position is applied to the trajectory generator. It will generate a position demand value for the position control function.



**Annotation**

Items marked with an asterisk (\*) refer to internal values.

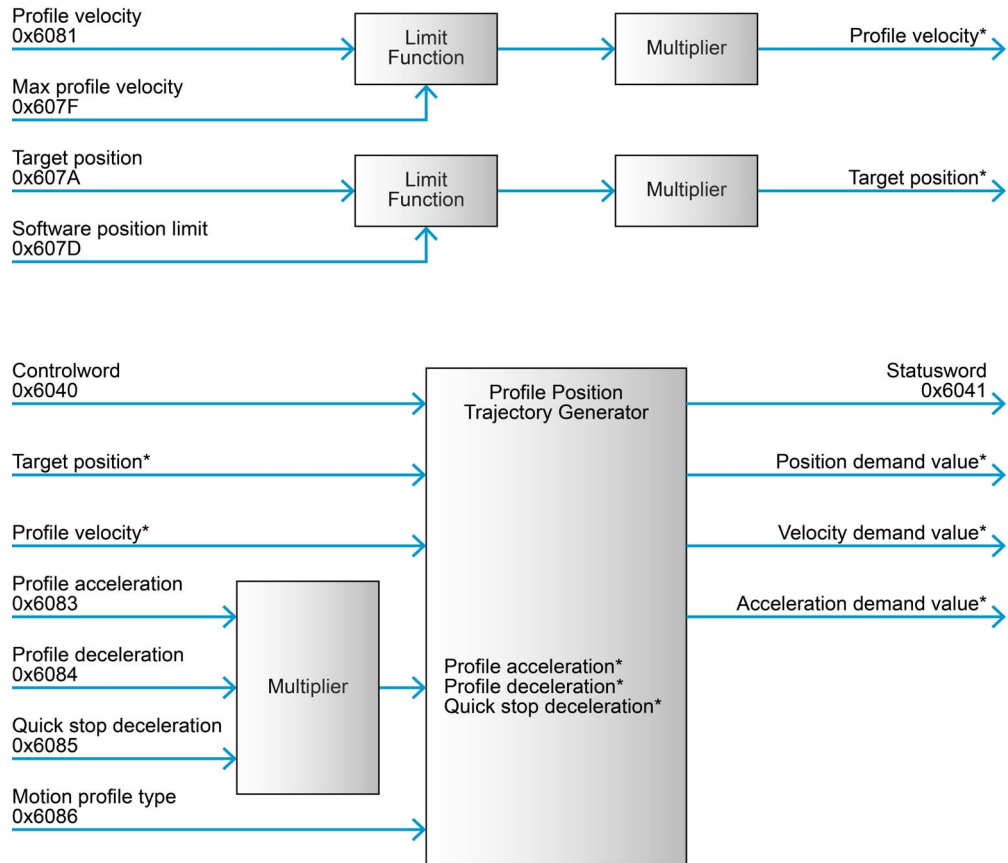

Figure 3-5 Profile Position Mode – Block diagram

### 3.3.1 Profile Position Trajectory Generator

The trajectory generator supports the following motion profiles.

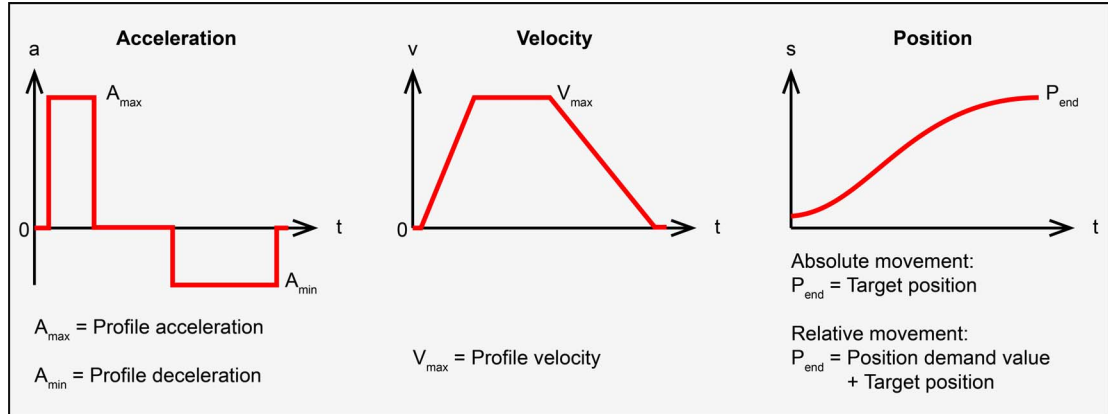

Figure 3-6 Profile position trajectory – Linear ramp (trapezoidal profile)

### 3.3.2 How to use «PPM»

#### CONFIGURATION PARAMETERS

Parameter	Index	Description
→ Software position limit	0x607D	Contains the sub-parameters “Min position limit” and “Max position limit” that define the absolute position limits of the position demand value and position actual value. A new target position will be checked against these limits.
→ Max profile velocity	0x607F	Defines the maximal permitted speed
→ Max motor speed	0x6080	Indicates the configured maximal permitted speed for the motor. It serves as protection of the motor and is taken from the motor data sheet.
→ Max gear input speed	0x3003	Indicates the configured maximal permitted input speed of the gear. It serves as protection of the gear and is taken from the gear data sheet. Together with “Max motor speed”, it limits the speed of the system.
→ Quick stop deceleration	0x6085	Defines the deceleration ramp during a «Quick stop»
→ Max acceleration	0x60C5	Defines the maximal allowed acceleration and deceleration

Table 3-12 Profile Position Mode – Configuration parameters

## COMMANDING PARAMETERS

Parameter	Index	Description
→Controlword	0x6040	The mode will be controlled by a write access to the controlword's mode-dependent bits
→Target position	0x607A	The position to which the drive is supposed to move using the motion control parameters, such as velocity, acceleration, motion profile type, etc. It will be interpreted as absolute or relative depending on the controlword "abs / rel" flag.
→Profile velocity	0x6081	The velocity normally attained at the end of the acceleration ramp during a profiled move
→Profile acceleration	0x6083	Defines the acceleration ramp during a movement
→Profile deceleration	0x6084	Defines the deceleration ramp during a movement
→Motion profile type	0x6086	Selects the type of motion profile used for the movement: 0 = linear ramp (trapezoidal profile)

Table 3-13 Profile Position Mode – Commanding parameters

## CONTROLWORD (PROFILE POSITION MODE-SPECIFIC BITS)

To perform system endless movements, the "endless movement" bit can be set. Speed is given by →"Profile velocity" on page 6-236 while direction is given by the sign of →"Target position" on page 6-232.

Bit 15	Bit 14...9	Bit 8	Bit 7	Bit 6	Bit 5	Bit 4	Bit 3...0
Endless movement	→Table 6-144	Halt	→Table 6-144	Abs / rel	Change set immediately	New setpoint	→Table 6-144

Table 3-14 Profile Position Mode – Controlword

Name	Value	Description
New setpoint	0	Does not assume →Target position
	0→1	Assume →Target position
Change set immediately	0	Finish actual positioning, then start next positioning. The actual positioning is considered as completed as soon as the position demand value reaches the target position.
	1	Abort actual positioning and start next positioning
Abs / rel	0	→Target position is an absolute value
	1	→Target position is a relative value
Halt	0	Execute or continue positioning
	1	Stop axis with →Profile deceleration
Endless movement	0	Normal operation mode
	1	System will perform endless movement

Table 3-15 Profile Position Mode – Controlword bits

## OUTPUT PARAMETERS

Parameter	Index	Description
→Statusword	0x6041	Mode state can be observed by the statusword bits
→Position demand value	0x6062	The output of the trajectory generator. It is used as input for the position control function.

Table 3-16 Profile Position Mode – Output parameters

**STATUSWORD (PROFILE POSITION MODE-SPECIFIC BITS)**

Bit 15, 14	Bit 13	Bit 12	Bit 11	Bit 10	Bit 9...0
→Table 6-145	Following error	Setpoint acknowledge	→Table 6-145	Target reached	→Table 6-145

Table 3-17 Profile Position Mode – Statusword

Name	Value	Description
Target reached	0	Halt = 0: →Target position not reached Halt = 1: Axis decelerates
	1	Halt = 0: →Target position reached Halt = 1: Velocity of axis is "0" (zero)
Setpoint acknowledge	0	Positioning to the previous setpoint is ongoing and a new setpoint may be accepted
	1	The previous setpoint has been assumed and no additional setpoint may be accepted
Following error	0	Not following error
	1	Following error

Table 3-18 Profile Position Mode – Statusword bits

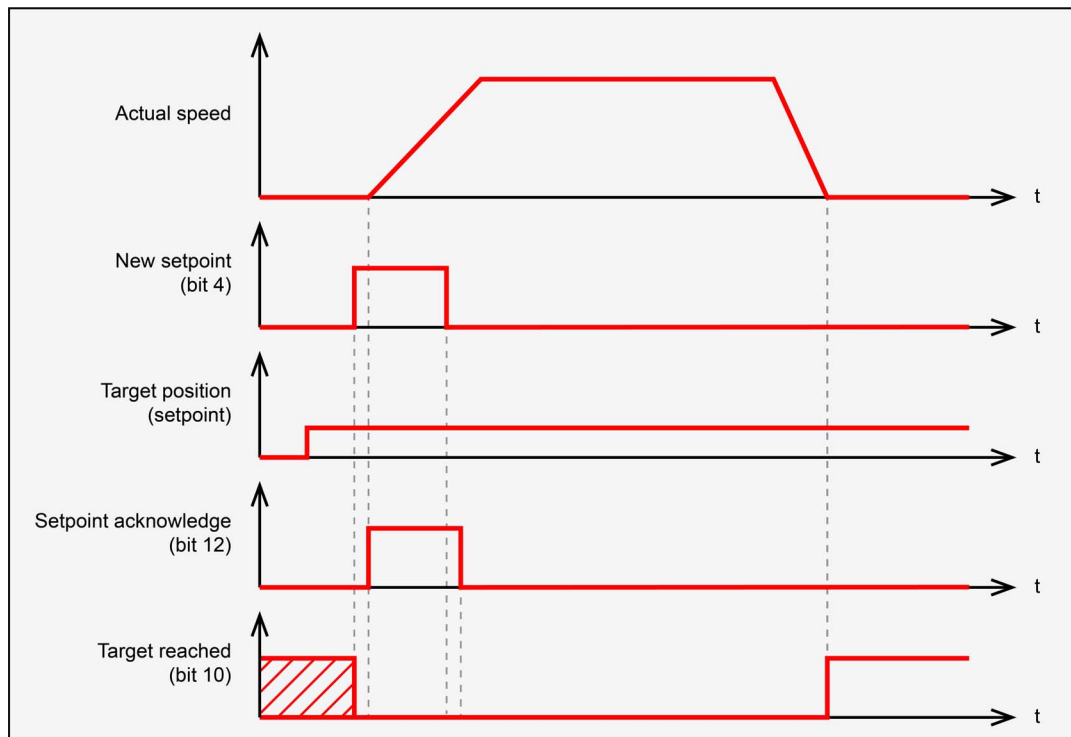

Figure 3-7 Profile Position Mode – Setpoint (example)

### 3.4 Profile Velocity Mode (PVM)

The profile velocity mode includes a velocity trajectory generator and a velocity control function.



**Annotation**

Items marked with an asterisk (\*) refer to internal values.

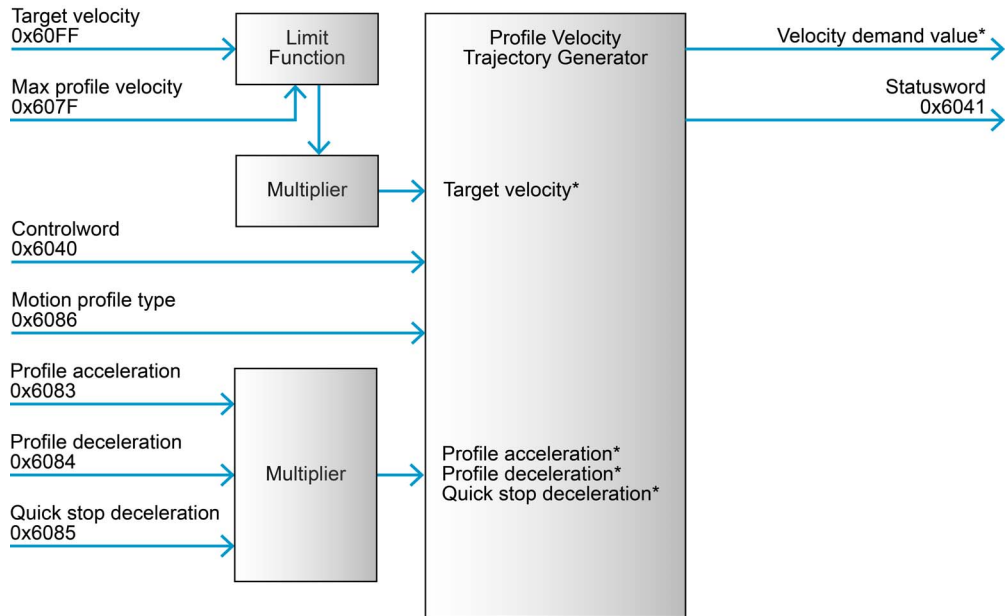

Figure 3-8 Profile Velocity Mode – Block diagram

#### 3.4.1 Profile Velocity Trajectory Generator

The trajectory generator supports the following motion profiles.

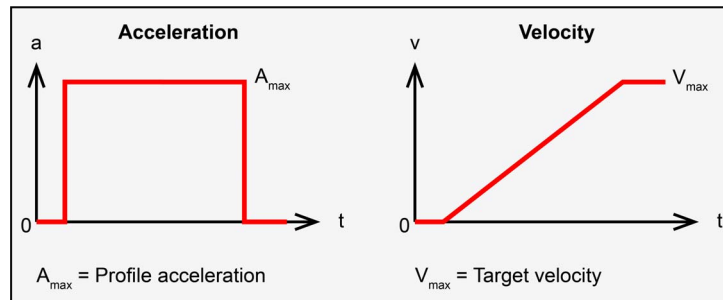

Figure 3-9 Profile velocity trajectory – Linear ramp (trapezoidal profile)

### 3.4.2 How to use «PVM»

#### CONFIGURATION PARAMETERS

Parameter	Index	Description
→ Software position limit	0x607D	Contains the sub-parameters “Min position limit” and “Max position limit” that define the absolute position limits of the position demand value and position actual value. A new target position will be checked against these limits.
→ Max profile velocity	0x607F	Defines the maximal permitted speed
→ Max motor speed	0x6080	Indicates the configured maximal permitted speed for the motor. It serves as protection of the motor and is taken from the motor data sheet.
→ Max gear input speed	0x3003	Indicates the configured maximal permitted input speed of the gear. It serves as protection of the gear and is taken from the gear data sheet. Together with “Max motor speed”, it limits the speed of the system.
→ Quick stop deceleration	0x6085	Defines the deceleration ramp during a «Quick stop»
→ Max acceleration	0x60C5	Defines the maximal allowed acceleration and deceleration

Table 3-19 Profile Velocity Mode – Configuration parameters

#### COMMANDING PARAMETERS

Parameter	Index	Description
→ Controlword	0x6040	The mode will be controlled by a write access to the controlword's mode-dependent bits. A new target velocity is not assumed before the controlword is written.
→ Target velocity	0x60FF	The speed that the drive is supposed to reach
→ Profile acceleration	0x6083	Defines the acceleration ramp during a movement
→ Profile deceleration	0x6084	Defines the deceleration ramp during a movement
→ Motion profile type	0x6086	Selects the type of motion profile used for the movement: 0 = linear ramp (trapezoidal profile)

Table 3-20 Profile Velocity Mode – Commanding parameters

#### CONTROLWORD (PROFILE VELOCITY MODE-SPECIFIC BITS)

Bit 15...9	Bit 8	Bit 7	Bit 6...4	Bit 3...0
→ Table 6-144	Halt	→ Table 6-144	reserved	→ Table 6-144

Table 3-21 Profile Velocity Mode – Controlword

Name	Value	Description
Halt	0	Execute or continue motion
	1	Stop axis

Table 3-22 Profile Velocity Mode – Controlword bits



## OUTPUT PARAMETERS

Parameter	Index	Description
→ Statusword	0x6041	Mode state can be observed by the statusword bits
→ Velocity demand value	0x606B	The output of the trajectory generator. It is used as input for the velocity control function.

Table 3-23 Profile Velocity Mode – Output parameters

## STATUSWORD (PROFILE VELOCITY MODE-SPECIFIC BITS)

Bit 15, 14	Bit 13	Bit 12	Bit 11 (*2)	Bit 10	Bit 9...0
→ Table 6-145	Not used	Speed	Speed is limited	Target reached	→ Table 6-145

(\*2) Bit 11 is shared with I2t current limitation feature

Table 3-24 Profile Velocity Mode – Statusword

Name	Value	Description
Target reached	0	Halt = 0: Target velocity not (yet) reached Halt = 1: Axis decelerates
	1	Halt = 0: Target velocity reached Halt = 1: Axis has velocity "0" (zero)
Speed	0	Speed is not equal "0" (zero)
	1	Speed is equal "0" (zero)
Speed is limited	0	Speed is not limited
	1	Speed is limited to → Max profile velocity

Table 3-25 Profile Velocity Mode – Statusword bits

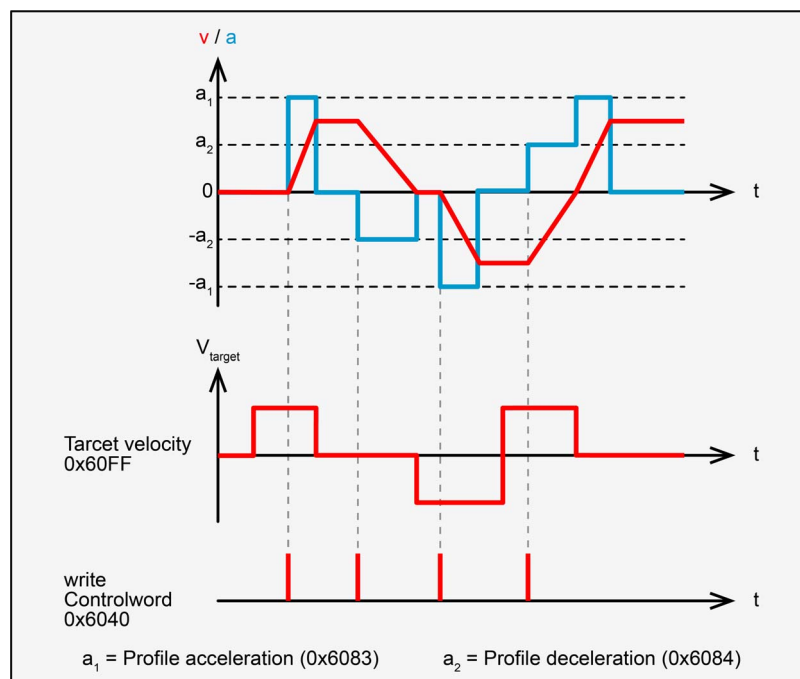

Figure 3-10 Profile velocity trajectory – Setpoint and acceleration behavior (example)

### 3.5 Homing Mode (HMM)

«Homing» describes the procedure according to which the drive seeks the home position (also called reference point or zero point). There are various methods to achieve this using limit switches at both ends of travel. Some of the methods use the index (zero) pulse train of an incremental encoder.



**Annotation**

Items marked with an asterisk (\*) refer to internal values.

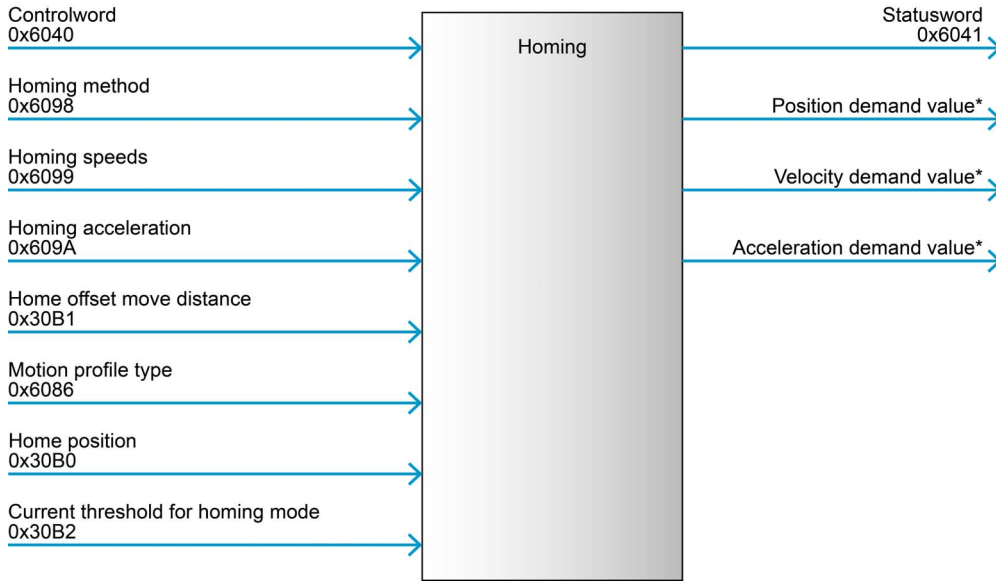

Figure 3-11 Homing Mode – Block diagram

#### 3.5.1 Homing Trajectory Generator

The trajectory generator supports the following motion profiles. The movements are mode-dependent, the end positions will be calculated internally.

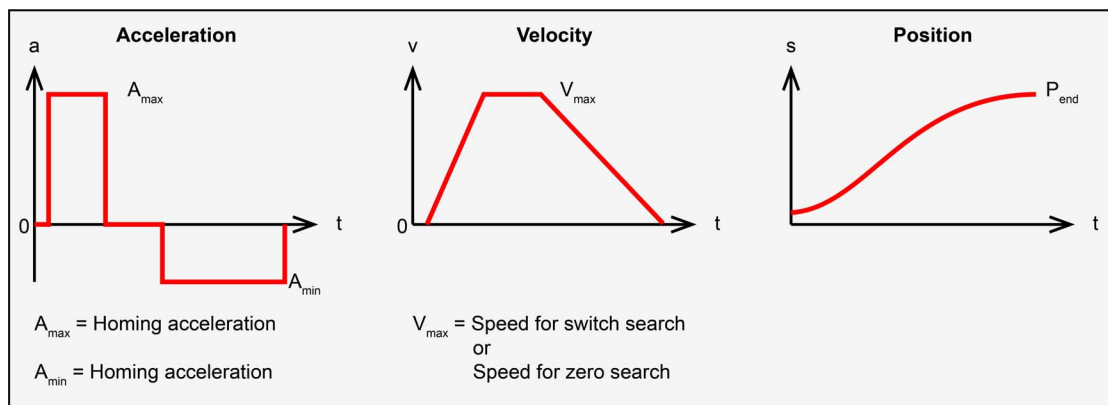

Figure 3-12 Homing trajectory – Linear ramp (trapezoidal profile)

### 3.5.2 How to use «HMM»

#### CONFIGURATION PARAMETERS

Parameter	Index	Description
→ Digital input properties	0x3141	Input polarity and logic state
→ Configuration of digital inputs	0x3142	Permits the configuration of digital inputs to digital input functionalities. Necessary for limit and homing switches that are used for «Homing».
→ Digital inputs	0x3141	Input functionality state (after polarity correction)
→ Motion profile type	0x6086	Selects the type of motion profile used for the movement: 0 = linear ramp (trapezoidal profile)

Table 3-26 Homing Mode – Configuration parameters

#### COMMANDING PARAMETERS

Parameter	Index	Description
→ Controlword	0x6040	The mode will be controlled by a write access to the controlword's mode-dependent bits
→ Homing method	0x6098	Defines the type of homing procedure. The object 0x60E3 provides the supported homing methods.
→ Homing speeds	0x6099	Specifies the two speeds used for Homing: In a typical cycle, the faster speed is used to find the home switch and for the offset move, the slower speed is used to find the index pulse.
→ Homing acceleration	0x609A	Specifies the acceleration during Homing
→ Home offset move distance	0x30B1	The distance to move away from a detected position upon end of the homing sequence
→ Home position	0x30B0	Allows to displace zero in the user's coordinate system
→ Current threshold for homing mode	0x30B2	The current threshold for current index homing methods

Table 3-27 Homing Mode – Commanding parameters

#### CONTROLWORD (HOMING MODE-SPECIFIC BITS)

Bit 15...9	Bit 8	Bit 7	Bit 6, 5	Bit 4	Bit 3...0
→ Table 6-144	Halt	→ Table 6-144	reserved	Homing operation start	→ Table 6-144

Table 3-28 Homing Mode – Controlword

Name	Value	Description
Homing operation start	0	Do not start homing procedure
	0→1	Start or continue homing procedure
Halt	0	Execute instruction of bit 4
	1	Stop axis with →Homing acceleration

Table 3-29 Homing Mode – Controlword bits

### OUTPUT PARAMETERS

Parameter	Index	Description
→ Statusword	0x6041	Mode state can be observed by the statusword bits

Table 3-30 Homing Mode – Output parameters

### STATUSWORD (HOMING MODE-SPECIFIC BITS)

Bit 15	Bit 14	Bit 13	Bit 12	Bit 11	Bit 10	Bit 9...0
Position referenced to home position	→ Table 6-145	Homing error	Homing attained	→ Table 6-145	Target reached	→ Table 6-145

Table 3-31 Homing Mode – Statusword

Name	Value	Description
Bit 15 Position referenced to home position	0	The position is not referenced to the home position (for example homing not yet attained or position overflow)
	1	Homing was attained and the position is referenced to the home position

Table 3-32 Homing Mode – Statusword bit 15

Bit 13 Homing error	Bit 12 Homing attained	Bit 10 Target reached	Description
0	0	0	Homing procedure is in progress
0	0	1	Homing procedure is interrupted or not started
0	1	X	Homing procedure is completed successfully
1	0	X	Homing error occurred

Table 3-33 Homing Mode – Statusword bits 10, 12, and 13

### 3.5.3 Homing Methods

The index used for homing can be either a hardware index impulse (incremental encoder) or a virtual index (SSI sensor).

#### 3.5.3.1 Homing Method 1 (Negative Limit Switch & Index)

The initial direction of the movement is negative (here to the left) if the negative limit switch is inactive (here shown as low).

- The axis moves with →Speed for switch search to the positive edge of the limit switch (1).
- The axis moves with →Speed for zero search to the negative edge of the limit switch and further to the first encoder index pulse after the negative edge of the limit switch (2).
- The axis moves the →Home offset move distance (3) in positive direction with →Speed for switch search. This point will be used as reference for all further moves and is set to →Home position (4).

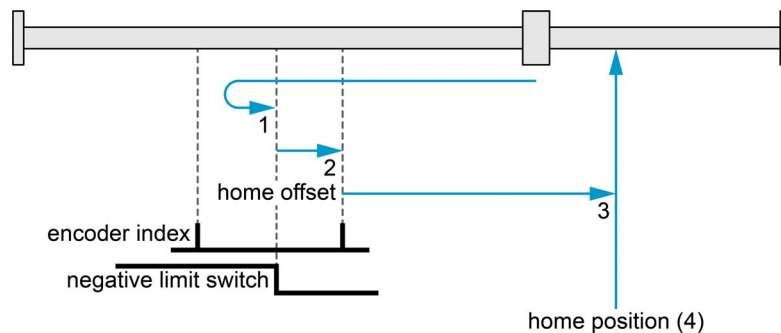

Figure 3-13 Homing method 1

#### 3.5.3.2 Homing Method 2 (Positive Limit Switch & Index)

The initial direction of the movement is positive (here to the right) if the positive limit switch is inactive (here shown as low).

- The axis moves with →Speed for switch search to the positive edge of the limit switch (1).
- The axis moves with →Speed for zero search to the negative edge of the limit switch and further to the first encoder index pulse after the negative edge of the limit switch (2).
- The axis moves the →Home offset move distance (3) in negative direction with →Speed for switch search. This point will be used as reference for all further moves and is set to →Home position (4).

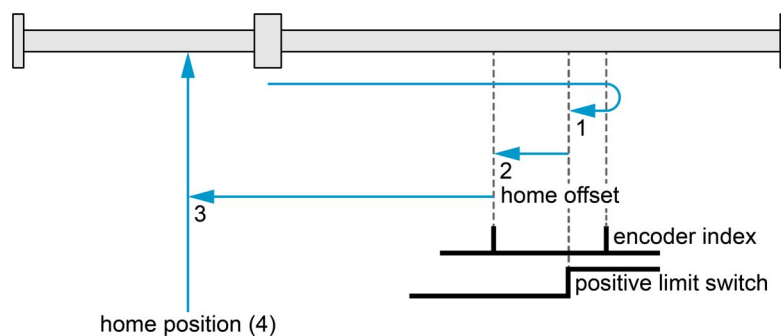

Figure 3-14 Homing method 2

### 3.5.3.3 Homing Method 7 (Home Switch Positive Speed & Index)

The method uses a home switch, which is active only during part of the movement. In effect, the switch acts as the position of the axis sweeps past the switch. The initial direction of the movement is positive (here to the right) except when the home switch is already active upon start of the movement.

- The axis moves with  $\rightarrow$ Speed for switch search to the positive edge of the limit switch (1).
- The axis moves with  $\rightarrow$ Speed for zero search to the encoder index pulse (2).
- The axis moves the  $\rightarrow$ Home offset move distance (3) with  $\rightarrow$ Speed for switch search. This point will be used as reference for all further moves and is set to  $\rightarrow$ Home position (4).

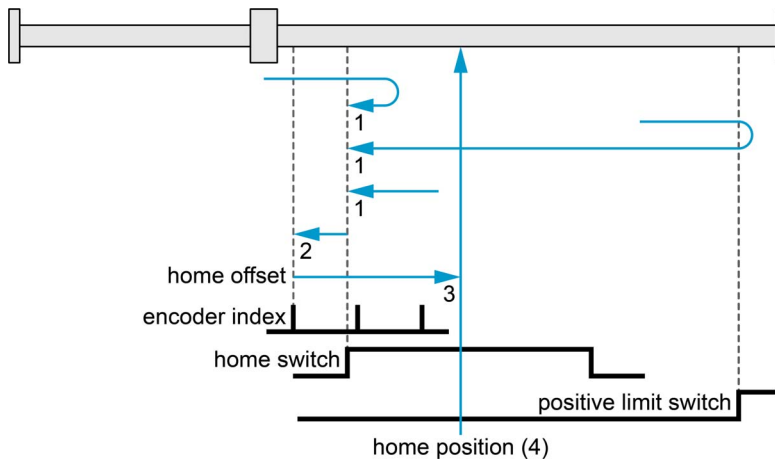

Figure 3-15 Homing method 7

### 3.5.3.4 Homing Method 11 (Home Switch Negative Speed & Index)

The method uses a home switch, which is active only during part of the movement. In effect, the switch acts as the position of the axis sweeps past the switch. The initial direction of the movement is negative (here to the left) except when the home switch is already active upon start of the movement.

- The axis moves with  $\rightarrow$ Speed for switch search to the positive edge of the limit switch (1).
- The axis moves with  $\rightarrow$ Speed for zero search to the encoder index pulse (2).
- The axis moves the  $\rightarrow$ Home offset move distance (3) with  $\rightarrow$ Speed for switch search. This point will be used as reference for all further moves and is set to  $\rightarrow$ Home position (4).

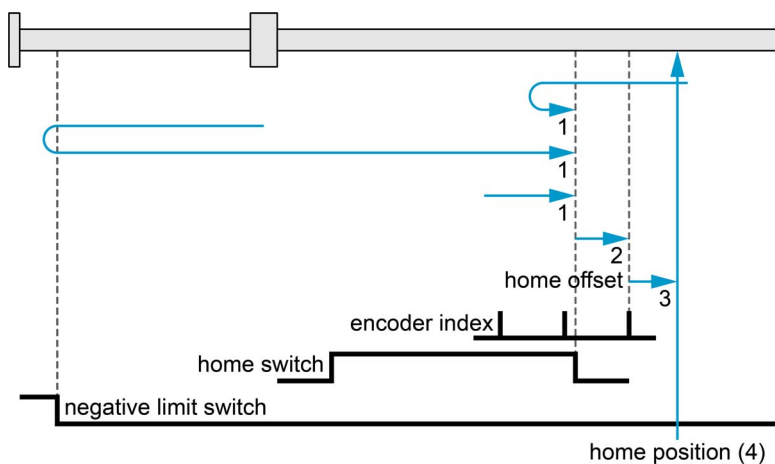

Figure 3-16 Homing method 11

**3.5.3.5 Homing Method 17 (Negative Limit Switch)**

The principle is similar to homing method 1 except that the →Home position is not dependent on the index pulse but only on the negative edge of the negative limit switch.

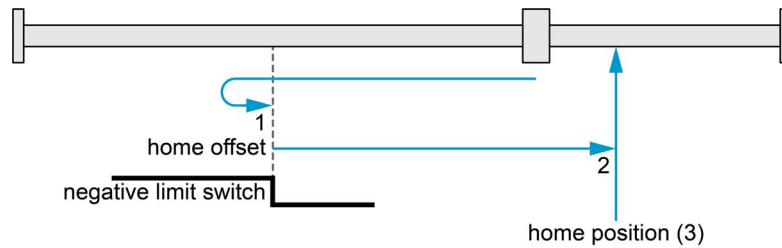

Figure 3-17 Homing method 17

**3.5.3.6 Homing Method 18 (Positive Limit Switch)**

The principle is similar to homing method 2 except that the →Home position is not dependent on the index pulse but only on the positive edge of the positive limit switch.

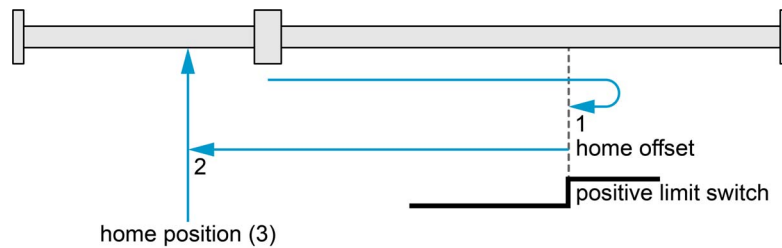

Figure 3-18 Homing method 18

**3.5.3.7 Homing Method 23 (Home Switch Positive Speed)**

The principle is similar to homing method 7 except that the →Home position is not dependent on the index pulse but only on the rising edge of the home switch.

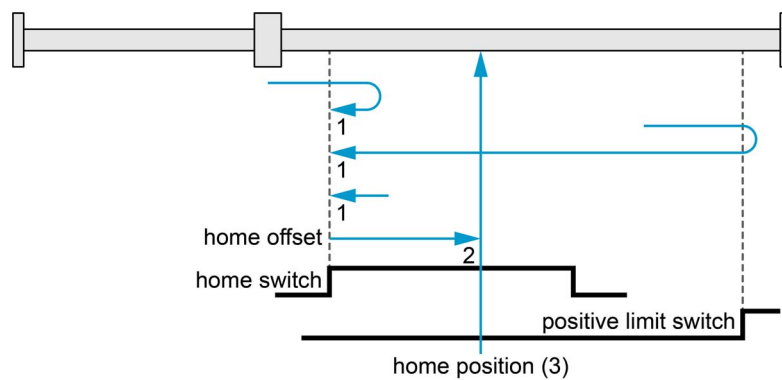

Figure 3-19 Homing method 23

### 3.5.3.8 Homing Method 27 (Home Switch Negative Speed)

The principle is similar to homing method 11 except that the →Home position is not dependent on the index pulse but only on the falling edge of the home switch.

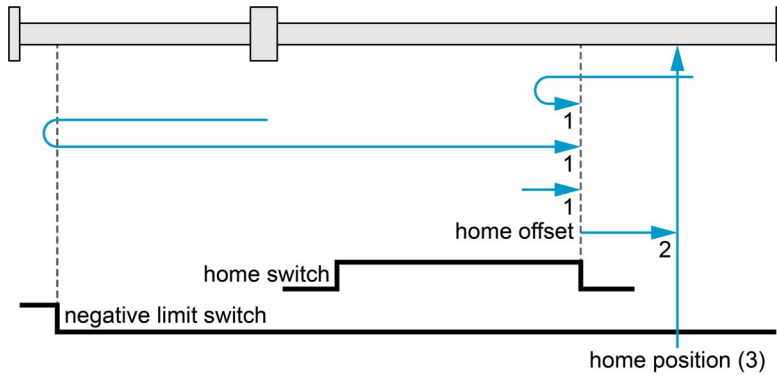

Figure 3-20 Homing method 27

### 3.5.3.9 Homing Method 33 (Index Negative Speed)

The direction for homing is negative (here to the left).

- The axis moves with →Speed for zero search to the next encoder index pulse (33).
- The axis moves the →Home offset move distance (2) with →Speed for switch search. This point will be used as reference for all further moves and is set to →Home position (4).

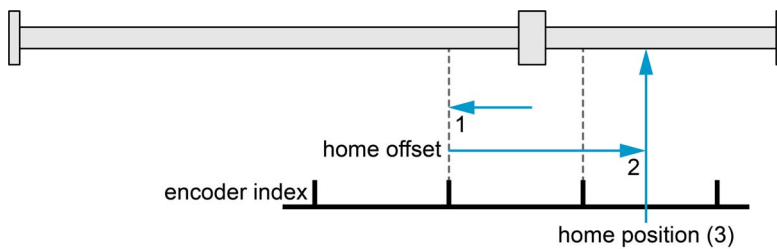

Figure 3-21 Homing method 33

### 3.5.3.10 Homing Method 34 (Index Positive Speed)

The direction for homing is positive (here to the right).

- The axis moves with →Speed for zero search to the next encoder index pulse (34).
- The axis moves the →Home offset move distance (2) with →Speed for switch search. This point will be used as reference for all further moves and is set to →Home position (4).

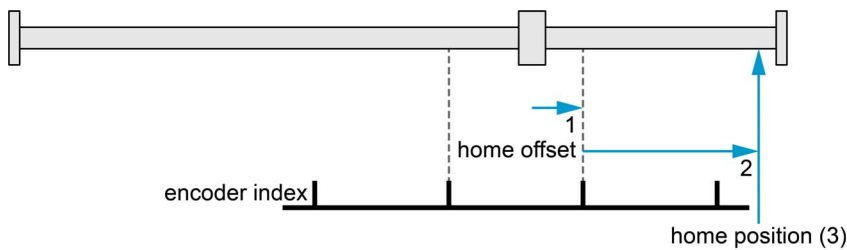

Figure 3-22 Homing method 34



### 3.5.3.11 Homing Method 37 (Actual Position)

The actual position is changed and considered as the future →Home position. The homing method may be used even if the axis is disabled.

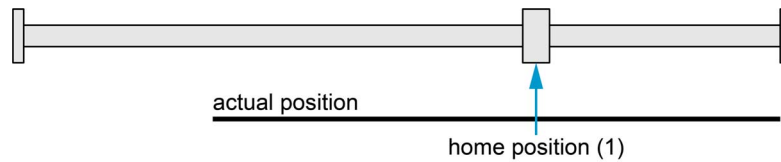

Figure 3-23 Homing method 37

### 3.5.3.12 Homing Method -1 (Current Threshold Positive Speed & Index)

The method uses a mechanical end stop on the right (positive) side. The edge is detected when the averaged output current rises above →Current threshold for homing mode.

- The axis moves with →Speed for switch search to the mechanical end stop (1).
- The axis moves with →Speed for zero search to the next encoder index pulse (2).
- The axis moves the →Home offset move distance (3) with →Speed for switch search. This point will be used as reference for all further moves and is set to →Home position (4).

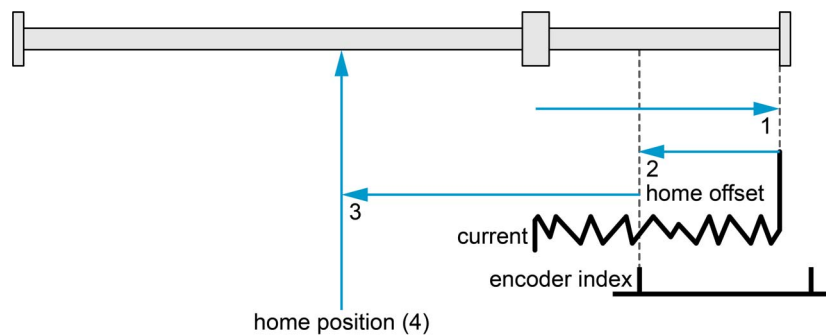

Figure 3-24 Homing method -1

### 3.5.3.13 Homing Method -2 (Current Threshold Negative Speed & Index)

The method uses a mechanical end stop on the left (negative) side. The edge is detected when the averaged output current rises above →Current threshold for homing mode.

- The axis moves with →Speed for switch search to the mechanical end stop (1).
- The axis moves with →Speed for zero search to the next encoder index pulse (2).
- The axis moves the →Home offset move distance (3) with →Speed for switch search. This point will be used as reference for all further moves and is set to →Home position (4).

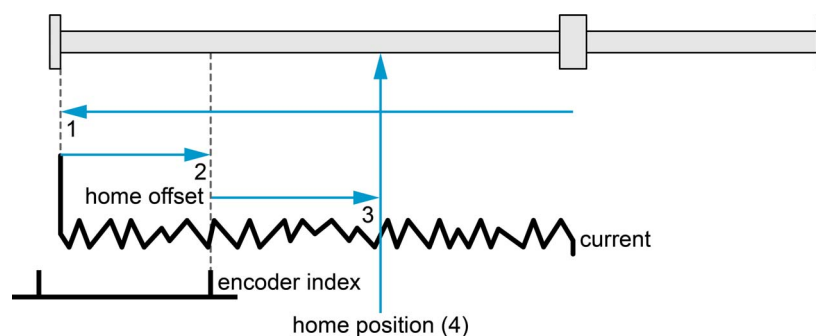

Figure 3-25 Homing method -2

### 3.5.3.14 Homing Method -3 (Current Threshold Positive Speed)

The principle is similar to homing method -1 except that the →Home position is not dependent on the index pulse but only on the mechanical end stop.

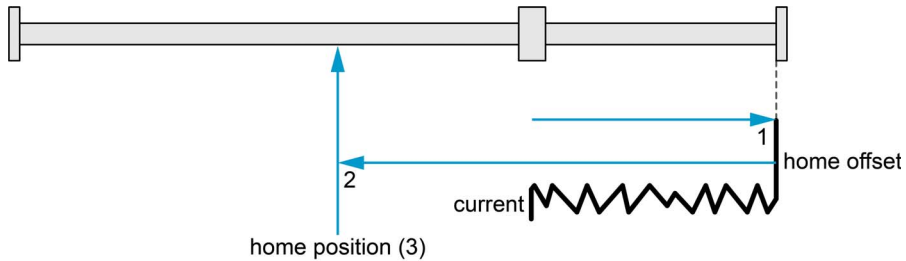

Figure 3-26 Homing method -3

### 3.5.3.15 Homing Method -4 (Current Threshold Negative Speed)

The principle is similar to homing method -2 except that the →Home position is not dependent on the index pulse but only on the mechanical end stop.

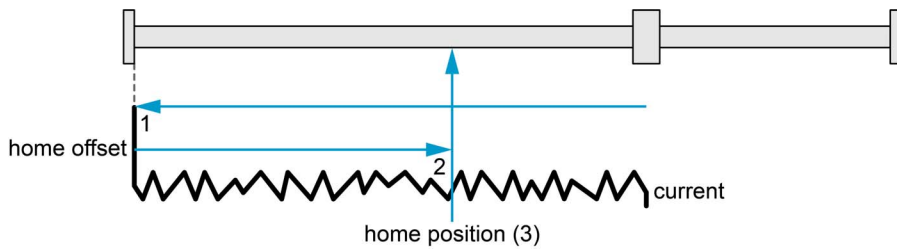

Figure 3-27 Homing method -4

### 3.6 Cyclic Synchronous Position Mode (CSP)

With Cyclic Synchronous Position Mode, the trajectory generator is located in the control device (not in the drive device). It provides a target position to the drive device in cyclic synchronous manner, thus the drive performing position control and torque control.

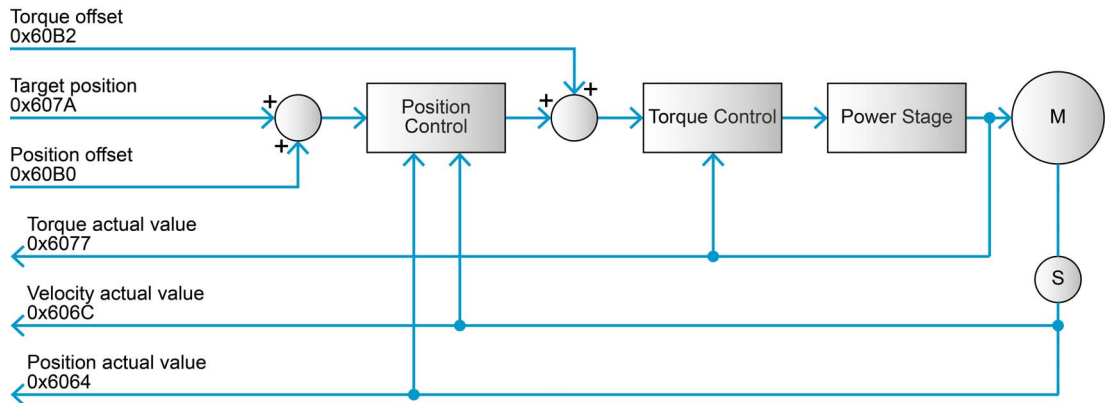

Figure 3-28 Cyclic Synchronous Position Mode – Overview

Cyclic Synchronous Position Mode is based on a position control function. The inputs are →Target position and (optionally) →Position offset. A linear interpolation based on the →Interpolation time period is executed between two position values. This interpolation is active for PDO communication only. The →Velocity offset is not taken into account.

Furthermore, an optional torque offset is being used for feed forward control. The input →Motor data is used to define limitations for the current value (torque). Other features specified in this mode are the function →Software position limit (used to restrict the range of values to avoid unintended positions) as well as →Max motor speed and →Max gear input speed (to limit and monitor the following error). Actual values for position, velocity, and torque are used as output to the control device.

Continued on next page.

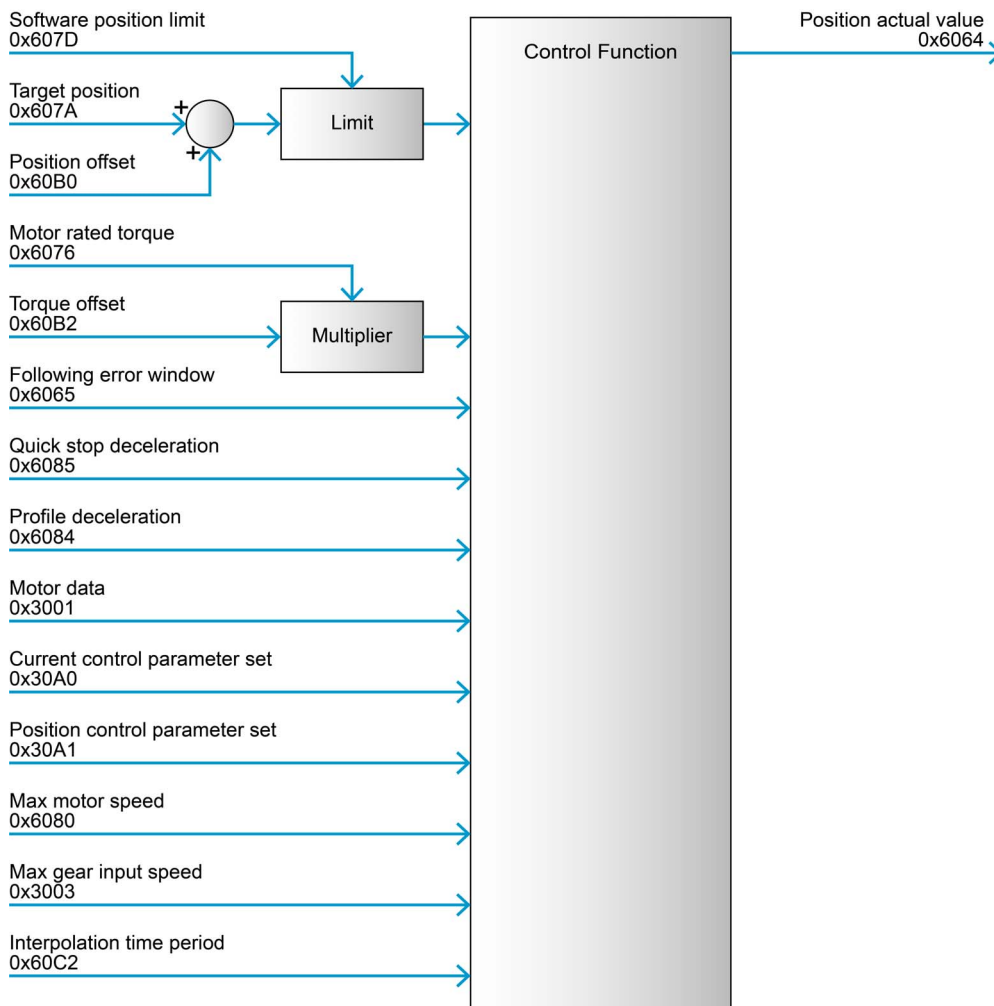

Figure 3-29 Cyclic Synchronous Position Mode – Block diagram

### 3.6.1 How to use «CSP»

#### CONFIGURATION PARAMETERS

Parameter	Index	Description
Nominal current (→Motor data)	0x3001	The maximal permissible continuous current of the motor
Motor torque constant (→Motor data)	0x3001	The torque constant of the motor
→Current control parameter set	0x30A0	Configuration of the current controller gains
→Position control parameter set	0x30A1	Configuration of the position controller.
→Quick stop deceleration	0x6085	Defines the deceleration for the quick stop ramp (*3)
→Profile deceleration	0x6084	Defines the deceleration for the slowdown ramp (*3)
→Following error window	0x6065	The maximal allowed difference of position actual value to position demand value. If exceeded, following error is generated.
→Software position limit	0x607D	Used to restrict the absolute position range. If the target position or the actual position exceeds the range, a software position limit error is generated.
→Motor rated torque	0x6076	Holds the value to which all torque objects are related to
→Max motor speed	0x6080	Indicates the configured maximal permitted speed for the motor. It serves as protection of the motor and is taken from the motor data sheet (active during PDO communication only).
→Max gear input speed	0x3003	Indicates the configured maximal permitted input speed of the gear. It serves as protection of the gear and is taken from the gear data sheet. Together with "Max motor speed", it limits the speed of the system (active during PDO communication only).
→Interpolation time period	0x60C2	Defines the time interval

(\*3) Deceleration values are used for stopping only (and not for normal operation).

Table 3-34 Cyclic Synchronous Position Mode – Configuration parameters

#### COMMANDING PARAMETERS

Parameter	Index	Description
→Target position	0x607A	Position input value for the position controller (linear interpolation between PDO values)
→Position offset	0x60B0	Optional additive position value which is added to the target position (linear interpolation between PDO values)
→Torque offset	0x60B2	Optional torque feed forward input

Table 3-35 Cyclic Synchronous Position Mode – Commanding parameters

#### CONTROLWORD

Cyclic Synchronous Position Mode does not use mode-specific controlword bits.

### OUTPUT PARAMETERS

Parameter	Index	Description
→ Torque actual value	0x6077	Actual motor torque value
→ Velocity actual value	0x606C	Actual velocity value [velocity units]
→ Position actual value	0x6064	Actual position is absolute and referenced to system zero position

Table 3-36 Cyclic Synchronous Position Mode – Output parameters

### STATUSWORD (CYCLIC SYNCHRONOUS POSITION MODE-SPECIFIC BITS)

Bit 15, 14	Bit 13	Bit 12	Bit 11	Bit 10	Bit 9...0
→ Table 6-145	following error	drive follows command value	→ Table 6-145	reserved	→ Table 6-145

Table 3-37 Cyclic Synchronous Position Mode – Statusword

Name	Value	Description
drive follows command value	0	Drive does not follow the target value
	1	Drive is in state operation enables and follows the target and setpoint values of the control device
following error	0	No following error
	1	Difference of position demand value and position actual value exceeds the defined maximal following error

Table 3-38 Cyclic Synchronous Position Mode – Statusword bits

### 3.7 Cyclic Synchronous Velocity Mode (CSV)

With Cyclic Synchronous Velocity Mode, the trajectory generator is located in the control device (not in the drive device). It provides a target velocity to the drive device in cyclic synchronous manner, thus the drive velocity control and torque control.

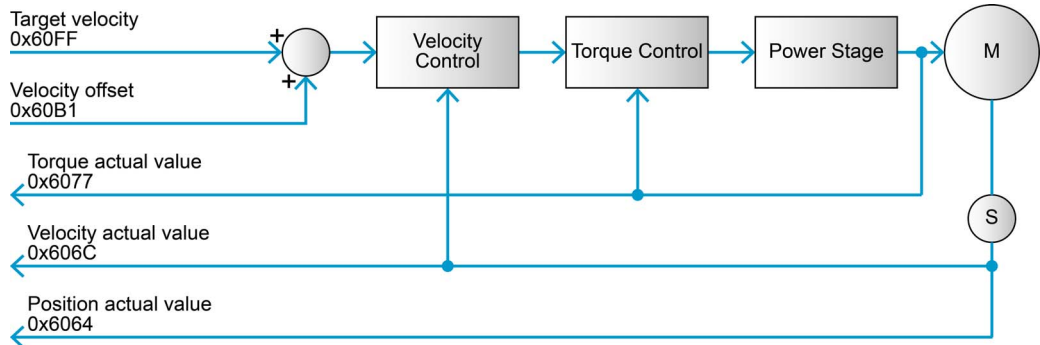

Figure 3-30 Cyclic Synchronous Velocity Mode – Overview

Cyclic Synchronous Velocity Mode is based on velocity control function. The inputs are → Target velocity. Optionally, additive velocity values may be provided by the control system in order to allow a second source for velocity feed forward control. A linear interpolation based on the → Interpolation time period is executed between two velocity values. This interpolation is active for PDO communication only. The → Torque offset is not taken into account.

The input → Motor data is used to define limitations for velocity and current values. Actual values for position, velocity, and torque are used as output to the control device

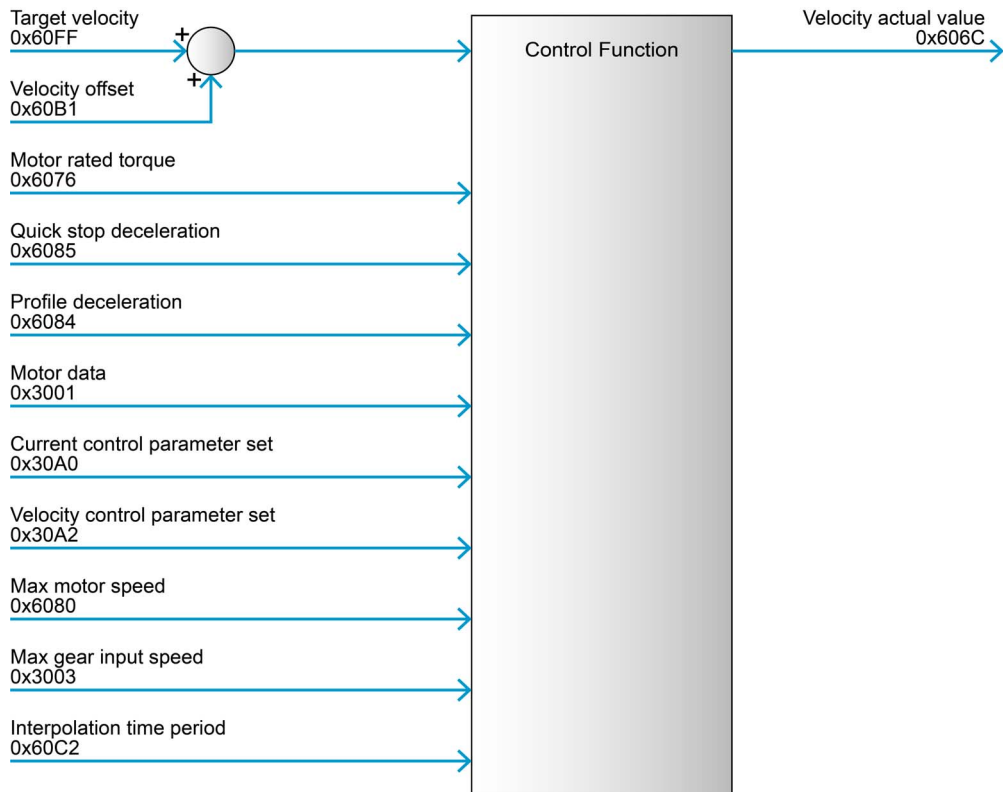

Figure 3-31 Cyclic Synchronous Velocity Mode – Block diagram

### 3.7.1 How to use «CSV»

#### CONFIGURATION PARAMETERS

Parameter	Index	Description
Nominal current (→Motor data)	0x3001	The maximal permissible continuous current of the motor
Motor torque constant (→Motor data)	0x3001	The torque constant of the motor
→Current control parameter set	0x30A0	Configuration of the current controller gains
→Velocity control parameter set	0x30A2	Configuration of the velocity controller
→Quick stop deceleration	0x6085	Defines the deceleration for the quick stop ramp (*3)
→Profile deceleration	0x6084	Defines the deceleration for the slowdown ramp (*3)
→Software position limit	0x607D	Used to restrict the absolute position range. If the actual position exceeds the range, a software position limit error is generated.
→Motor rated torque	0x6076	Holds the value to which all torque objects are related to
→Max motor speed	0x6080	Indicates the configured maximal permitted speed for the motor. It serves as protection of the motor and is taken from the motor data sheet (active during PDO communication only).
→Max gear input speed	0x3003	Indicates the configured maximal permitted input speed of the gear. It serves as protection of the gear and is taken from the gear data sheet. Together with “Max motor speed”, it limits the speed of the system (active during PDO communication only).
→Interpolation time period	0x60C2	Defines the time interval

(\*3) Deceleration values are used for stopping only (and not for normal operation).

Table 3-39 Cyclic Synchronous Velocity Mode – Configuration parameters

#### COMMANDING PARAMETERS

Parameter	Index	Description
→Target velocity	0x60FF	Velocity input value for the velocity controller
→Velocity offset	0x60B1	Optional velocity feed forward input

Table 3-40 Cyclic Synchronous Velocity Mode – Commanding parameters

#### CONTROLWORD

Cyclic Synchronous Velocity Mode does not use mode-specific controlword bits.

#### OUTPUT PARAMETERS

Parameter	Index	Description
→Torque actual value	0x6077	Actual motor torque value
→Velocity actual value	0x606C	Actual velocity value [velocity units]
→Position actual value	0x6064	Actual position is absolute and referenced to system zero position

Table 3-41 Cyclic Synchronous Velocity Mode – Output parameters



### STATUSWORD (CYCLIC SYNCHRONOUS VELOCITY MODE-SPECIFIC BITS)

Bit 15, 14	Bit 13	Bit 12	Bit 11	Bit 10	Bit 9...0
→Table 6-145	reserved	drive follows command value	→Table 6-145	reserved	→Table 6-145

Table 3-42 Cyclic Synchronous Velocity Mode – Statusword

Name	Value	Description
drive follows command value	0	Drive does not follow the target value
	1	Drive is in state operation enables and follows the target and setpoint values of the control device

Table 3-43 Cyclic Synchronous Velocity Mode – Statusword bits

### 3.8 Cyclic Synchronous Torque Mode (CST)

With Cyclic Synchronous Torque Mode, the trajectory generator is located in the control device (not in the drive device). It provides a target torque to the drive device in cyclic synchronous manner, thus the drive performing torque control.

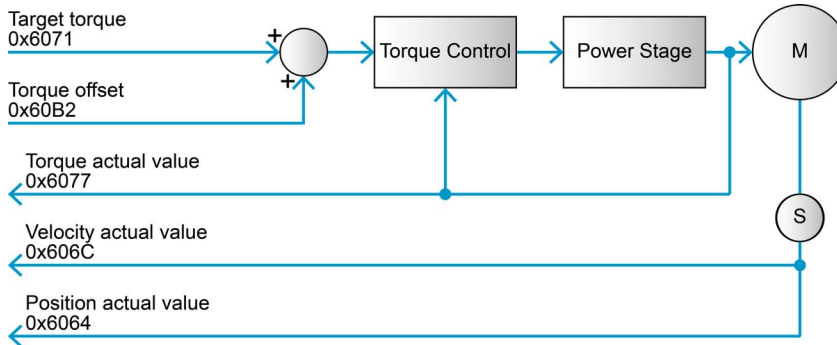

Figure 3-32 Cyclic Synchronous Torque Mode – Overview

Cyclic Synchronous Torque Mode is based on the current control function. The inputs are →Target torque and (optionally) →Torque offset. The input →Motor data is used to define limitations for velocity and current values. Actual values for position, velocity, and torque are used as output to the control device.

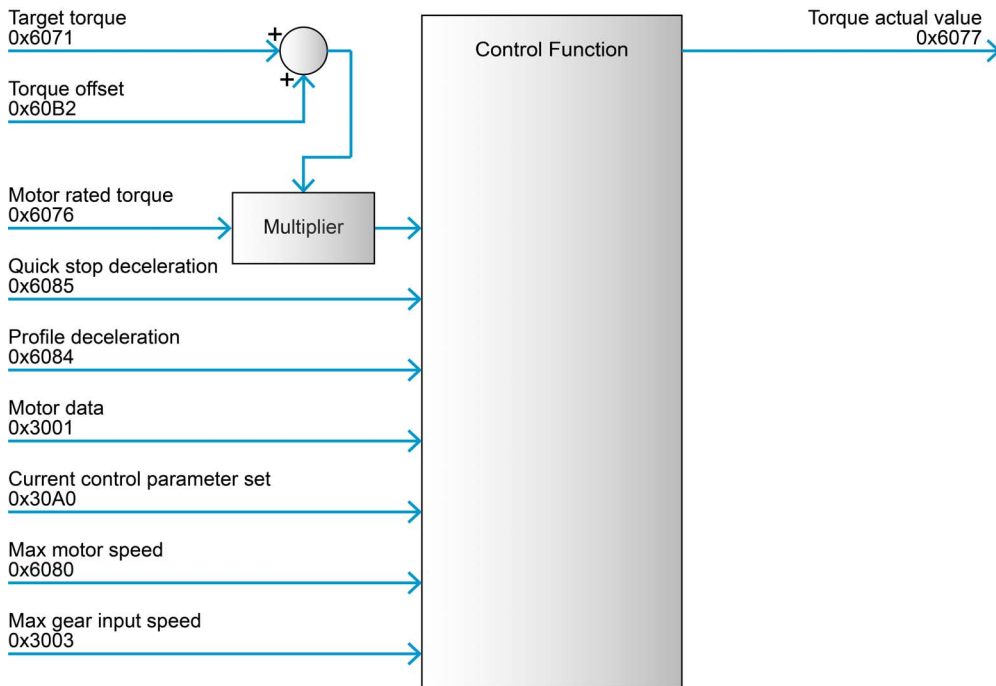

Figure 3-33 Cyclic Synchronous Torque Mode – Block diagram

### 3.8.1 How to use «CST»

#### CONFIGURATION PARAMETERS

Parameter	Index	Description
Nominal current (→Motor data)	0x3001	The maximal permissible continuous current of the motor
Motor torque constant (→Motor data)	0x3001	The torque constant of the motor
→Max motor speed	0x6080	Indicates the configured maximal allowed speed for the motor. It serves as protection of the motor and is taken from the motor data sheet.
→Max gear input speed	0x3003	Indicates the configured maximal permitted input speed of the gear. It serves as protection of the gear and is taken from the gear data sheet. Together with "Max motor speed", it limits the speed of the system.
→Current control parameter set	0x30A0	Configuration of the current controller gains
→Quick stop deceleration	0x6085	Defines the deceleration for the quick stop ramp (*4)
→Profile deceleration	0x6084	Defines the deceleration for the slowdown ramp (*4)
→Motor rated torque	0x6076	Holds the value to which all torque objects are related to
→Software position limit	0x607D	Contains the sub-parameters "Min position limit" and "Max position limit" that define the absolute position limits of the position demand value and position actual value. A new target position will be checked against these limits.

(\*4) Deceleration values are used for stopping only (and not for normal operation).

Table 3-44 Cyclic Synchronous Torque Mode – Configuration parameters

#### COMMANDING PARAMETERS

Parameter	Index	Description
→Target torque	0x6071	Torque input value for the torque controller
→Torque offset	0x60B2	Optional additive torque which is added to the target torque value

Table 3-45 Cyclic Synchronous Torque Mode – Commanding parameters

#### CONTROLWORD

Cyclic Synchronous Torque Mode does not use mode-specific controlword bits.

#### OUTPUT PARAMETERS

Parameter	Index	Description
→Torque actual value	0x6077	Actual motor torque value
→Velocity actual value	0x606C	Actual velocity value
→Position actual value	0x6064	Actual position is absolute and referenced to system zero position

Table 3-46 Cyclic Synchronous Torque Mode – Output parameters

**STATUSWORD (CYCLIC SYNCHRONOUS TORQUE MODE-SPECIFIC BITS)**

Bit 15, 14	Bit 13	Bit 12	Bit 11	Bit 10	Bit 9...0
→Table 6-145	reserved	drive follows command value	→Table 6-145	reserved	→Table 6-145

Table 3-47 Cyclic Synchronous Torque Mode – Statusword

Name	Value	Description
drive follows command value	0	Drive does not follow the target value
	1	Drive is in state operation enables and follows the target and setpoint values of the control device

Table 3-48 Cyclic Synchronous Torque Mode – Statusword bits

### 3.9 Position Control Function

Used for position-based modes, such as «Profile Position Mode» and «Homing Mode».

The control loop is fed with the «Position demand value» and «Position actual value» (the output of the position detection unit) like an encoder as input parameter. The behavior of the control may be influenced by externally applicable control parameters (Position Control Parameter Set). The output of the controller is a current demand value, which serves as input for the current controller.



**Annotation**

Items marked with an asterisk (\*) refer to internal values.

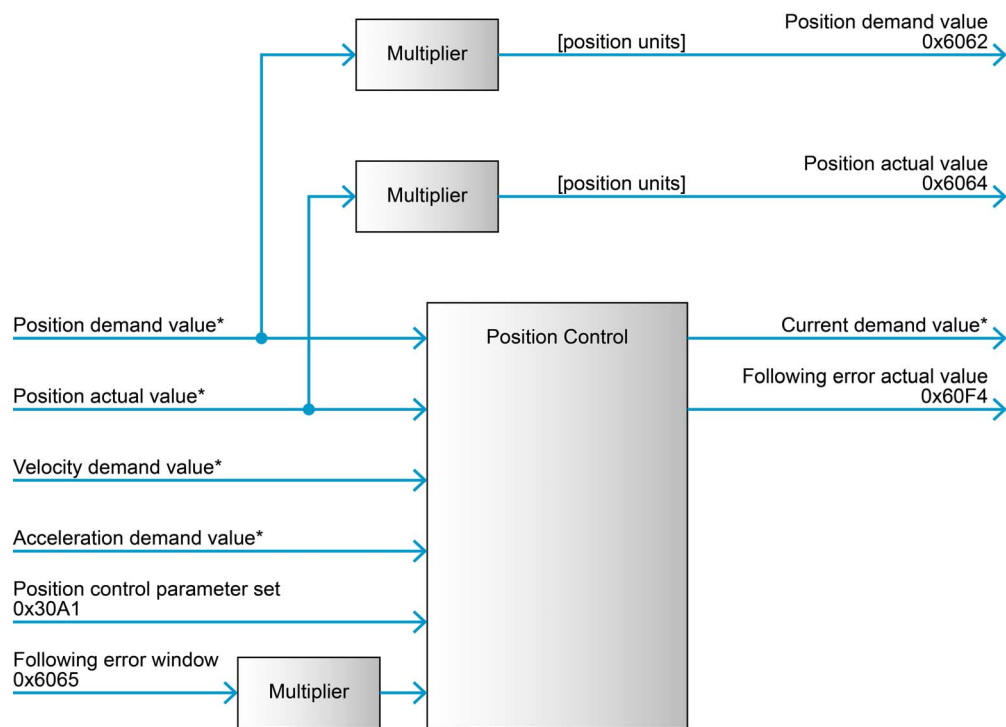

Figure 3-34 Position Control Function – Block diagram

#### 3.9.1 How to use «Position Control Function»

**CONFIGURATION PARAMETERS**

Parameter	Index	Description
→Following error window	0x6065	Defines the following error window. If the difference between Position Actual Value and Position Demand Value is larger than the following error window, a following error will occur.
→Position control parameter set	0x30A1	Configuration of the position controller. The parameters are defined by the controller properties bandwidth, reset time, and damping factor.

Table 3-49 Position Control Function – Configuration parameters

**COMMANDING PARAMETERS**

There are no commanding parameters. The Position Control Function is directly commanded by position-based operating modes (such as Profile Position Mode, Homing Mode).

### OUTPUT PARAMETERS

Parameter	Index	Description
→Position demand value	0x6062	The operation mode's output. It is used as input for the position control function. Generally, the value is the trajectory generator output.
→Position actual value	0x6064	The actual position is absolute and referenced to system zero position in position units.

Table 3-50 Position Control Function – Output parameters

### 3.10 Velocity Control Function

Used for velocity-based modes, such as «Profile Velocity Mode».

The control loop is fed with the «Velocity demand value» and «Position actual value» (the output of the position detection unit) like an encoder as input parameter. The behavior of the control may be influenced by externally applicable control parameters. The output of the controller is a current demand value, which serves as input for the current controller.



**Annotation**

Items marked with an asterisk (\*) refer to internal values.

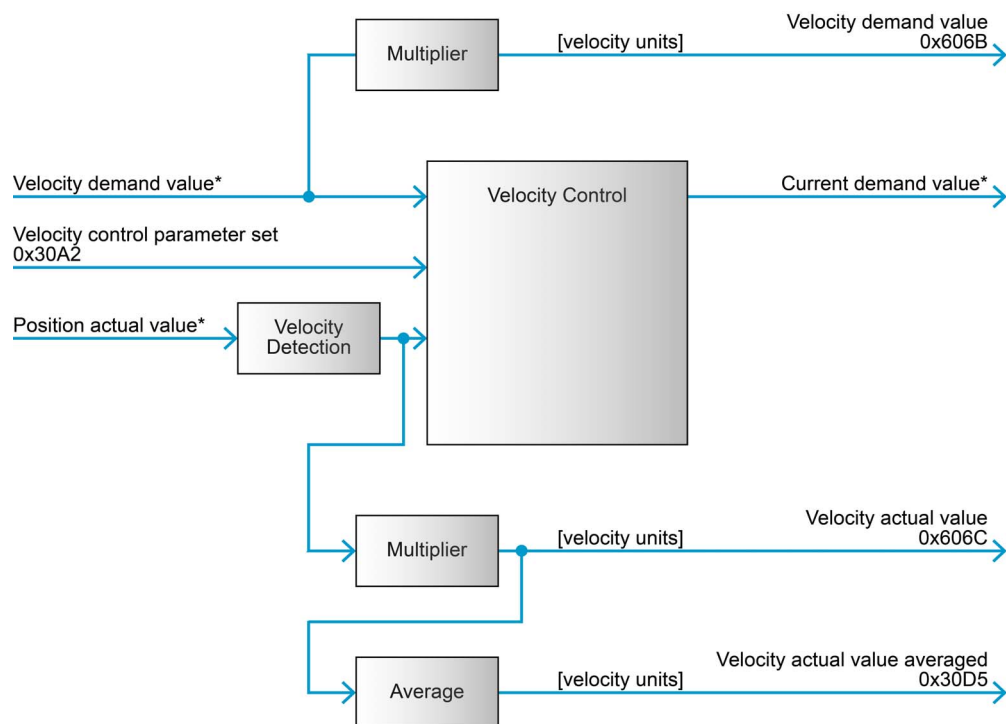

Figure 3-35 Velocity Control Function – Block diagram

#### 3.10.1 How to use «Velocity Control Function»

**CONFIGURATION PARAMETERS**

Parameter	Index	Description
→ Velocity control parameter set	0x30A2	Configuration of the velocity controller gains

Table 3-51 Velocity Control Function – Configuration parameters

**COMMANDING PARAMETERS**

There are no commanding parameters. The Velocity Control Function is directly commanded by velocity-based operating modes (such as Profile Velocity Mode).

### OUTPUT PARAMETERS

Parameter	Index	Description
→Velocity demand value	0x606B	The operation mode's output. It is used as input for the velocity control function. Generally, the value is the output of the trajectory generator.
→Velocity actual value	0x606C	The actual velocity value
→Velocity actual value averaged	0x30D5	The averaged actual velocity value

Table 3-52 Velocity Control Function – Output Parameters



## 3.11 Current Control Function

All operating modes are based on the current control function. The «Current demand value» is received from a superordinate position or the velocity controller.



### Annotation

Items marked with an asterisk (\*) refer to internal values.

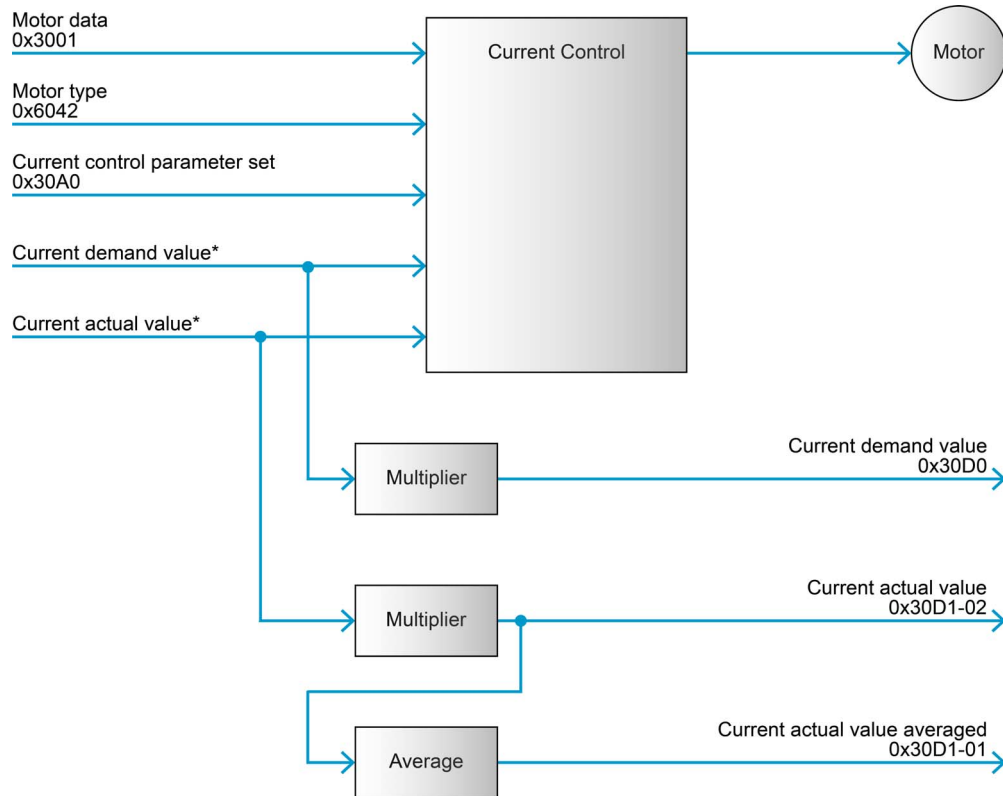

Figure 3-36 Current Control Function – Block diagram

### 3.11.1 How to use «Current Control Function»

#### CONFIGURATION PARAMETERS

Parameter	Index	Description
→ Current control parameter set	0x30A0	Configuration of the current controller gains
→ Motor data	0x3001	Used for configuration of motor-dependent parameters
→ Motor type	0x6402	Used to define the type of motor

Table 3-53 Current Control Function – Configuration parameters

#### COMMANDING PARAMETERS

There are no commanding parameters. The Current Control Function is commanded by the control loops «Position control function» or «Velocity control function», or directly by operating mode «Cyclic Synchronous Torque Mode».

**OUTPUT PARAMETERS**

Parameter	Index	Description
→Current demand value	0x30D0	Set value for current controller
→Current actual values	0x30D1	The averaged and actual current value

Table 3-54 Current Control Function – Output parameters

**3.11.2 Output Current Limitation according to I<sup>2</sup>t Method**

With properly setup →Motor data, the device will limit the output current according to I<sup>2</sup>t method with the parameters «Nominal current», «Output current limit», and «Thermal time constant winding». The I<sup>2</sup>t method assumes an ambient temperature of 25 °C. If this condition is not fulfilled, the output current must be reduced by adjusting the above mentioned parameters to the actual ambient temperature.

Heating-up of the motor is given as follows:

$$\vartheta = P_V \cdot R_{th} \cdot \left( 1 - e^{-\frac{t}{\tau_{th}}} \right) + \vartheta_a \cdot e^{-\frac{t}{\tau_{th}}}$$

$\vartheta$  calculated actual winding temperature

$P_V$  thermal dissipation loss

$R_{th}$  thermal resistance

$\vartheta_a$  temperature at beginning of measuring period

$\tau_{th}$  thermal time constant winding

Use the scale to determine the time during which the device can source a current (→Figure 3-37).

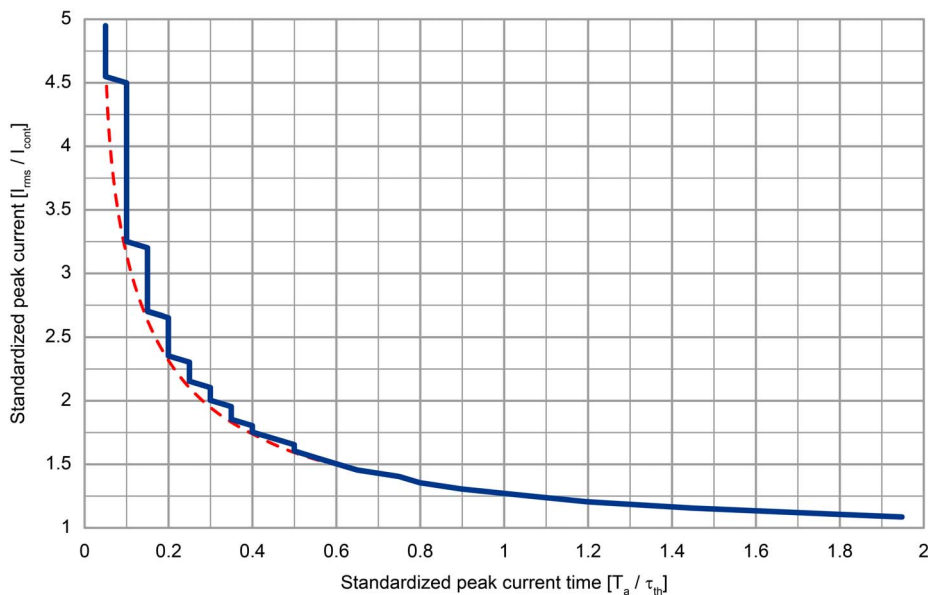

Figure 3-37 Standardized peak current vs. standardized peak current time

**EXAMPLE:**

Given configuration (for details see →“Motor data” on page 6-150):

- Current limit: 1470 mA
- Output current limit: 2940 mA
- Thermal time constant winding  $[\tau_{th}]$ : 2.8

At acceleration time  $[T_a]$ , the motor needs a higher acceleration current  $[I_a]$ . The EPOS4’s current limiting method according to I2t fulfills this need.

For how long (maximal) does the device source the higher acceleration current  $[I_a] = 2940 \text{ mA}$ ?

- Standardized peak current =  $2940 \text{ mA} / 1470 \text{ mA} = 2$
- Standardized peak current time  $\rightarrow 0.3$
- The resulting acceleration time  $T_p = 0.3 \cdot \text{thermal time constant winding} = 0.3 \cdot 2.8 \text{ s} = 840 \text{ ms}$ .

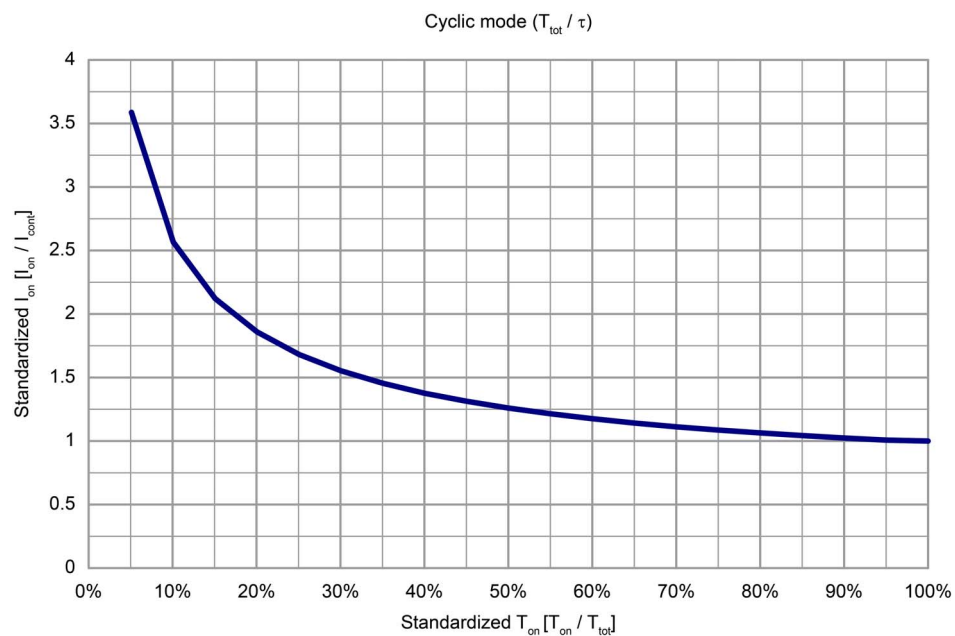

Figure 3-38 Cyclic mode standardized vs. standardized “ON time”

- standardized  $T_{on}$  ratio of “ON time” vs. total time
- standardized  $I_{on}$  current at “ON time” standardized with «Continuous current limit»

**EXAMPLE:**

Given configuration (for details see →“Motor data” on page 6-150):

- Application in “cyclic mode” – the current is switched on/off every 2.8 s.
- Thermal time constant winding: 2.8 s
- Continuous current limit: 1470 mA

For the “ON time” of 280 ms (10%), a standardized output current of 2.6 is possible. Therefore, the possible output current  $I_{on} = 2.6 \cdot \text{Continuous current limit} = 2.6 \cdot 1470 \text{ mA} = 3822 \text{ mA}$ .

••page intentionally left blank••

## 4 INPUTS AND OUTPUTS

### 4.1 Digital Inputs

Available are predefined functions and general purpose inputs for process control.

Configuration of the digital input functions is done with →“Configuration of digital inputs” on page 6-195, the polarity is set with →“Digital input properties” on page 6-193.

The input logic state is read with →“Digital input properties” on page 6-193 while the functionality state is read with →“Digital inputs” on page 6-261.

---

**HsDigIn3 is located on same pin as HsDigOut1**

---

**HsDigIn1, HsDigIn2, and HsDigIn3 are not available with...**

- «EPOS4 Disk 60/8»
  - «EPOS4 Disk 60/12»
  - «EPOS4 Micro 24/5»
- 

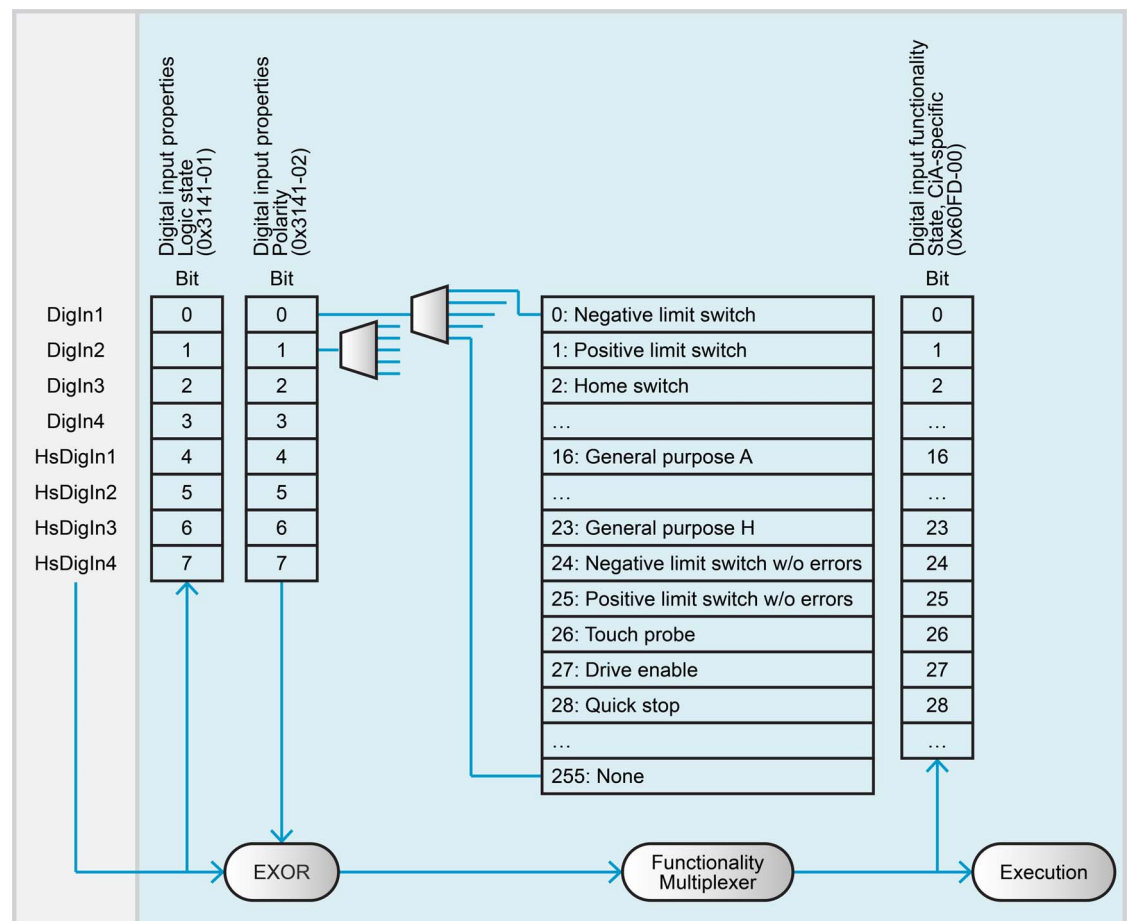

Figure 4-39 Digital input functionality

Continued on next page.

#### DIGITAL INPUT TIMING BEHAVIOR

- **Hardware** For details on voltage levels and switching delays see separate document → «Hardware Reference» of respective controller.
- **Software filter** The digital inputs are filtered to suppress spikes. For “regular” digital inputs, the filter has a length of 1 ms, for high-speed inputs the filter length is 500  $\mu$ s. Therefore, to detect a state change (edge), the input level must be stable for more than 1 ms, respectively 500  $\mu$ s.
- **Update rates** The digital input functionality states (→Digital inputs) and the →Digital input properties are updated with 1 kHz.

## 4.2 Digital Outputs

Available are predefined functions and general purpose outputs for process control.

Configuration of the digital output functions is done with →“Configuration of digital outputs” on page 6-198, the polarity is set with →“Digital output properties” on page 6-197.

The functionality state can be set with →“Digital outputs” on page 6-262, the logic state of the corresponding pin can be read with →“Digital output properties” on page 6-197.

---

**HsDigOut1 is located on same pin as HsDigIn3**

---

**HsDigOut2 is only available with...**

- «EPOS4 Disk 60/8»
  - «EPOS4 Disk 60/12»
- 

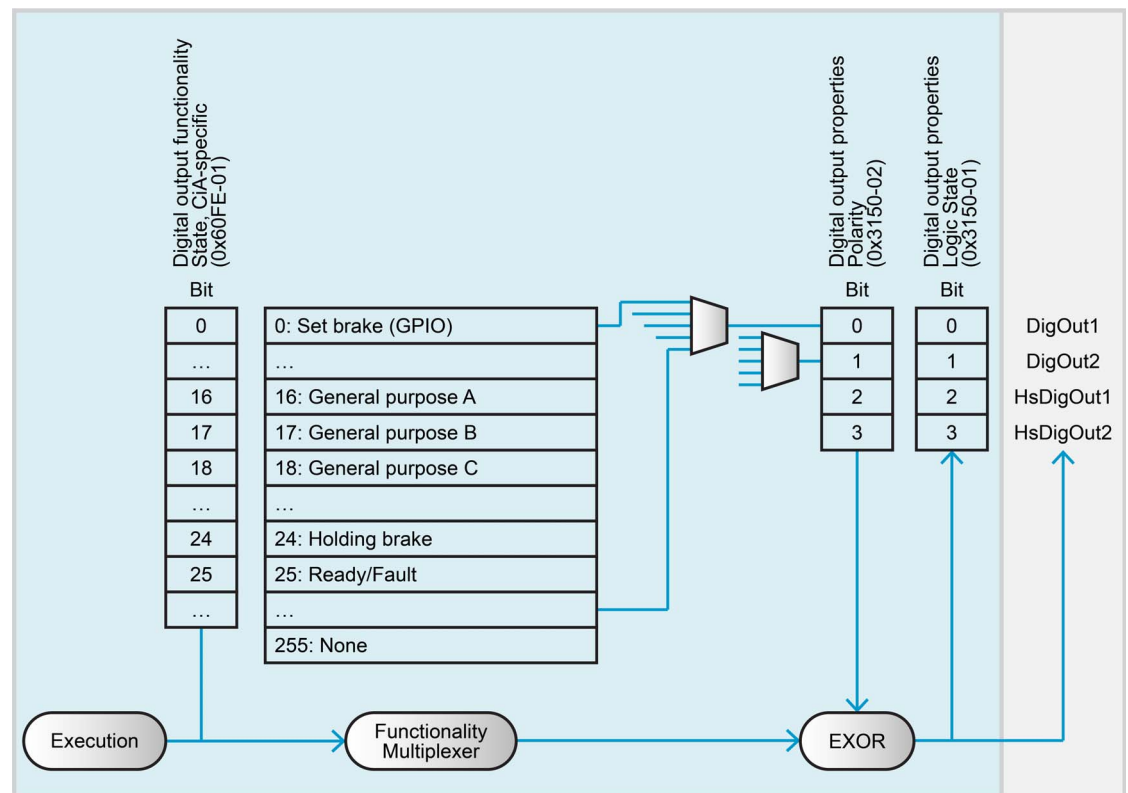

Figure 4-40 Digital output functionality

### DIGITAL OUTPUT TIMING BEHAVIOR

- **Hardware** For details on voltage levels and switching delays see separate document →«Hardware Reference» of respective controller.
- **Update rates** Digital outputs (→Digital outputs) are updated when the object is written, no update rate applies. The same applies for the logic state (→Digital output properties).

### 4.3 Analog Inputs

The analog inputs may be used for general purpose process values, such as temperature, pressure, torque from an external sensor, etc. The values are given in →“Analog input properties” on page 6-203.

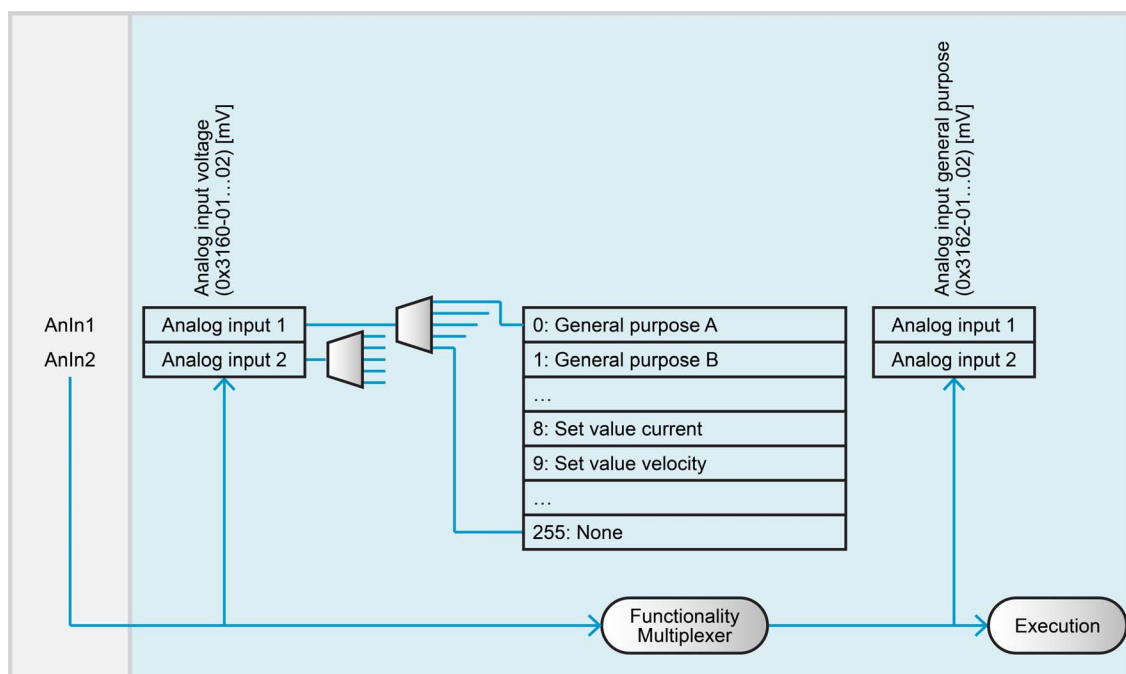

Figure 4-41 Analog input functionality



## 4.4 Analog Outputs

The analog outputs may be used for general purpose. The outputs are set by →“Analog output general purpose” on page 6-214 and displayed in →“Analog output properties” on page 6-212.

Configuration of the analog output functions is done with →“Configuration of analog outputs” on page 6-213.

### **AnOut2 is not available with...**

- «EPOS4 Disk 60/8»
- «EPOS4 Disk 60/12»
- «EPOS4 Micro 24/5»

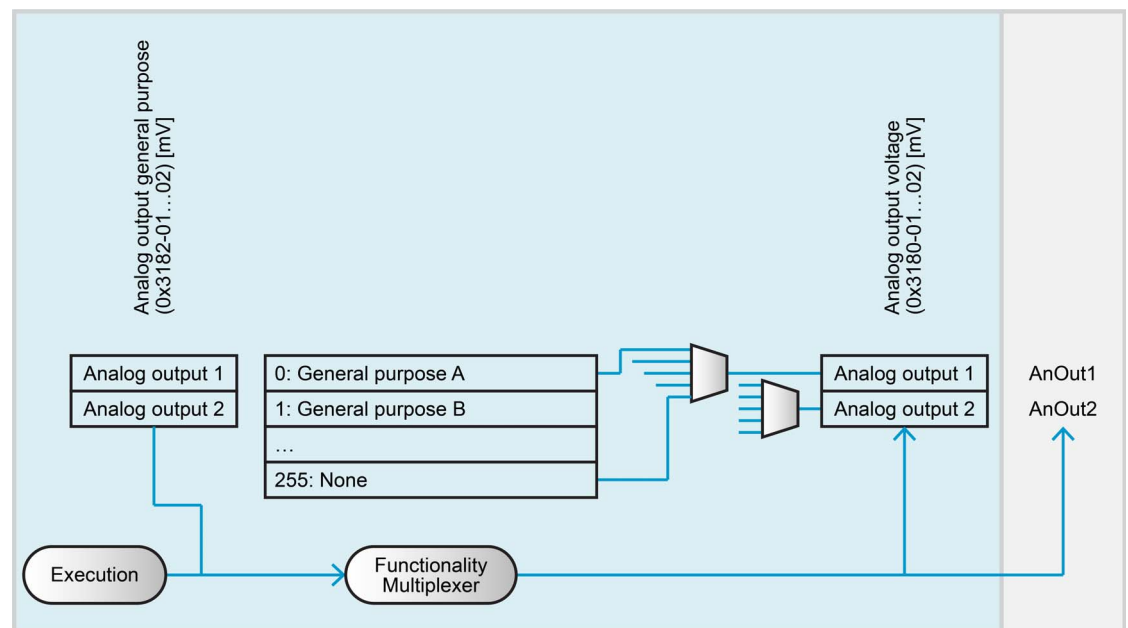

Figure 4-42 Analog output functionality

### **ANALOG OUTPUT TIMING BEHAVIOR**

- **Hardware** For details on voltage levels, resolution, and bandwidth see separate document →«Hardware Reference» of respective controller.
- **Update rates** Analog outputs configured as general purpose are updated when the object is written, no update rate applies.

••page intentionally left blank••

## 5 COMMUNICATION

The device supports communication profiles for USB, RS232, CANopen, and EtherCAT. You can find detailed information on the subject in the separate document → «EPOS4 Communication Guide». For sources of supply see → chapter “1.1.6 Sources for additional Information” on page 1-12.

### 5.1 USB & RS232 Communication

The device’s USB interface follows the «Universal Serial Bus Specification Revision 2.0».

The device’s communication protocol uses the RS232 standard to transmit data over a 3-wire cable.

The device always communicates as a slave and uses the «maxon Serial V2» protocol.



---

**Find details here:**

→ «EPOS4 Communication Guide», chapter “2 USB & RS232 Communication”

---

### 5.2 CAN Communication

The EPOS4’s CAN interface follows the CiA CANopen specifications:

- CiA 301 V4.2; CANopen application layer and communication profile
- CiA 306 V1.3; CANopen electronic data sheet specification
- CiA 402 V4.0; CANopen drives and motion control device profile



---

**Find details here:**

→ «EPOS4 Communication Guide», chapter “3 CAN Communication”

---

### 5.3 EtherCAT Communication

The EPOS4 can be extended with EtherCAT communication functionality. Depending on the hardware version this is done by using either an «EPOS4 EtherCAT Card» in one of the provided extension slots or a connector board with EtherCAT functionality.

The EPOS4’s EtherCAT communication follows the EtherCAT Technology Group’s and CiA CANopen specifications:

- ETG.1000 V1.0.4; EtherCAT Specification
- ETG.1020 V1.2.0; EtherCAT Protocol Enhancements Specification
- ETG.2000 V1.0.9; EtherCAT Slave Information (ESI) Specification
- CiA 402 V4.0; CANopen drives and motion control device profile



---

**Find details here:**

→ «EPOS4 Communication Guide», chapter “4 EtherCAT Communication”

---

## 5.4 Gateway Communication (USB/RS232 to CAN)

The EPOS4 provides USB-to-CAN and RS232-to-CAN gateways that permit the master to access all other EPOS4 or EPOS2 devices connected to the CAN bus via USB port or RS232 interface. In addition, other CANopen devices (I/O modules) that support the CANopen standard CiA 301 may also be accessed.



---

**Find details here:**

→«EPOS4 Communication Guide», chapter “5 Gateway Communication (USB or RS232 to CAN)”

---

## 6 OBJECT DICTIONARY

### 6.1 Overview

#### 6.1.1 Object Data Types

Index	Name	Base type	Description	Size [Bits]	Range
0x0001	BOOLEAN	BOOL	False/True	1	0.1
0x0002	INTEGER8	SINT	Short Integer	8	$-2^7 \dots 2^7 - 1$
0x0003	INTEGER16	INT	Integer	16	$-2^{15} \dots 2^{15} - 1$
0x0004	INTEGER32	DINT	Double Integer	32	$-2^{31} \dots 2^{31} - 1$
0x0015	INTEGER64	LINT	Long Integer	64	$-2^{63} \dots 2^{63} - 1$
0x0005	UNSIGNED8	USINT	Unsigned Short Integer	8	$0 \dots 2^8 - 1$
0x0006	UNSIGNED16	UINT	Unsigned Integer	16	$0 \dots 2^{16} - 1$
0x0007	UNSIGNED32	UDINT	Unsigned Double Integer	32	$0 \dots 2^{32} - 1$
0x001B	UNSIGNED64	ULINT	Unsigned Long Integer	64	$0 \dots 2^{64} - 1$
0x0009	VISIBLE_STRING	STRING(n)	Visible String (1 octet per character)	8*n	–
0x000A	OCTET_STRING	ARRAY[0...n] of USINT	Sequence of octets (data type USINT)	8*(n+1)	–
0x0021	PDO_MAPPING	–	PDO mapping Parameter Record	–	–
0x0023	IDENTITY	–	Identity Parameter Record	–	–

Table 6-55 Object data types

#### 6.1.2 Object Codes

Object code	Object name
0x0007	VAR
0x0008	ARRAY
0x0009	RECORD

Table 6-56 Object codes

#### 6.1.3 Object Access Types

Access type	Description
RW	read and write access
RO	read only access
WO	write only access
CONST	read only access value is constant

Table 6-57 Object access types

### 6.1.4 Object Flags

Flag	Code	Description
PDO mapping	TXPDO, RXPDO	Entry can be mapped as TxPdo or as RxPdo
Backup	YES/NO	Entry can be stored/not stored in non-volatile memory

Table 6-58 Object flags

### 6.1.5 Entries Overview

Index	Name	Object code	CANopen	EtherCAT
0x1000	→Device type	VAR	X	X
0x1001	→Error register	VAR	X	X
0x1003	→Error history	ARRAY	X	
0x1005	→COB-ID SYNC	VAR	X	
0x1008	→Manufacturer device name	VAR	X	X
0x1010	→Store parameters	ARRAY	X	X
0x1011	→Restore default parameters	ARRAY	X	X
0x1014	→COB-ID EMCY	VAR	X	
0x1016	→Consumer heartbeat time	ARRAY	X	
0x1017	→Producer heartbeat time	VAR	X	
0x1018	→Identity object	RECORD	X	X
0x1029	→Error behavior	ARRAY	X	
0x10F3	→Diagnosis History	RECORD		X
0x1200	→SDO server parameter	RECORD	X	
0x1400	→Receive PDO 1 parameter	RECORD	X	
0x1401	→Receive PDO 2 parameter	RECORD	X	
0x1402	→Receive PDO 3 parameter	RECORD	X	
0x1403	→Receive PDO 4 parameter	RECORD	X	
0x1600	→Receive PDO 1 mapping	RECORD	X	X
0x1601	→Receive PDO 2 mapping	RECORD	X	X
0x1602	→Receive PDO 3 mapping	RECORD	X	X
0x1603	→Receive PDO 4 mapping	RECORD	X	X
0x1800	→Transmit PDO 1 parameter	RECORD	X	
0x1801	→Transmit PDO 2 parameter	RECORD	X	
0x1802	→Transmit PDO 3 parameter	RECORD	X	
0x1803	→Transmit PDO 4 parameter	RECORD	X	
0x1A00	→Transmit PDO 1 mapping	RECORD	X	X
0x1A01	→Transmit PDO 2 mapping	RECORD	X	X
0x1A02	→Transmit PDO 3 mapping	RECORD	X	X
0x1A03	→Transmit PDO 4 mapping	RECORD	X	X
0x1C00	→SYNC manager communication type	ARRAY		X
0x1C12	→SYNC manager 2 PDO assignment	ARRAY		X

Continued on next page.

Index	Name	Object code	CANopen	EtherCAT
0x1C13	→SYNC manager 3 PDO assignment	ARRAY		X
0x1C32	→SYNC manager 2 parameter	RECORD		X
0x1C33	→SYNC manager 3 parameter	RECORD		X
0x1F50	→Program data	ARRAY	X	X
0x1F51	→Program control	ARRAY	X	X
0x1F56	→Program software identification	ARRAY	X	X
0x1F57	→Flash status identification	ARRAY	X	X
0x2000	→Node-ID	VAR	X	X
0x2001	→CAN bit rate	VAR	X	
0x2002	→RS232 bit rate	VAR	X	X
0x2005	→RS232 frame timeout	VAR	X	X
0x2006	→USB frame timeout	VAR	X	X
0x200A	→CAN bit rate display	VAR	X	
0x2010	→Active fieldbus	VAR	X	X
0x2100	→Additional identity	RECORD	X	X
0x2101	→Extension 1 identity	RECORD		X
0x210C	→Custom persistent memory	ARRAY	X	X
0x2200	→Power supply	RECORD	X	X
0x2201	→Power supply supervision	RECORD	X	X
0x3000	→Axis configuration	RECORD	X	X
0x3001	→Motor data	RECORD	X	X
0x3002	→Electrical system parameters	RECORD	X	X
0x3003	→Gear configuration	RECORD	X	X
0x3010	→Digital incremental encoder 1	RECORD	X	X
0x3011	→Analog incremental encoder	RECORD	X	X
0x3012	→SSI absolute encoder	RECORD	X	X
0x301A	→Digital Hall sensor	RECORD	X	X
0x3020	→Digital incremental encoder 2	RECORD	X	X
0x30A0	→Current control parameter set	RECORD	X	X
0x30A1	→Position control parameter set	RECORD	X	X
0x30A2	→Velocity control parameter set	RECORD	X	X
0x30A3	→Velocity observer parameter set	RECORD	X	X
0x30AE	→Dual loop position control parameter set	RECORD	X	X
0x30B0	→Home position	VAR	X	X
0x30B1	→Home offset move distance	VAR	X	X
0x30B2	→Current threshold for homing mode	VAR	X	X
0x30D0	→Current demand value	VAR	X	X
0x30D1	→Current actual values	ARRAY	X	X
0x30D2	→Torque actual values	ARRAY	X	X
0x30D3	→Velocity actual values	ARRAY	X	X
0x30E0	→Standstill window configuration	RECORD	X	X

Continued on next page.

Index	Name	Object code	CANopen	EtherCAT
0x3141	→Digital input properties	ARRAY	X	X
0x3142	→Configuration of digital inputs	ARRAY	X	X
0x3150	→Digital output properties	ARRAY	X	X
0x3151	→Configuration of digital outputs	ARRAY	X	X
0x3158	→Holding brake parameters	RECORD	X	X
0x3160	→Analog input properties	ARRAY	X	X
0x3161	→Configuration of analog inputs	ARRAY	X	X
0x3162	→Analog input general purpose	ARRAY	X	X
0x3163	→Analog input adjustment	RECORD	X	X
0x3170	→Analog input current set value properties	ARRAY	X	X
0x3171	→Analog input velocity set value properties	ARRAY	X	X
0x3180	→Analog output properties	ARRAY	X	X
0x3181	→Configuration of analog outputs	ARRAY	X	X
0x3182	→Analog output general purpose	ARRAY	X	X
0x3200	→Power limitation	RECORD	X	X
0x3201	→Thermal overload protection	RECORD	X	X
0x3202	→Functional safety	RECORD	X	X
0x3203	→Motor control	RECORD	X	X
0x6007	→Abort connection option code	VAR	X	X
0x603F	→Error code	VAR	X	X
0x6040	→Controlword	VAR	X	X
0x6041	→Statusword	VAR	X	X
0x605A	→Quick stop option code	VAR	X	X
0x605B	→Shutdown option code	VAR	X	X
0x605C	→Disable operation option code	VAR	X	X
0x605E	→Fault reaction option code	VAR	X	X
0x6060	→Modes of operation	VAR	X	X
0x6061	→Modes of operation display	VAR	X	X
0x6062	→Position demand value	VAR	X	X
0x6064	→Position actual value	VAR	X	X
0x6065	→Following error window	VAR	X	X
0x6066	→Following error time out	VAR	X	X
0x6067	→Position window	VAR	X	X
0x6068	→Position window time	VAR	X	X
0x606B	→Velocity demand value	VAR	X	X
0x606C	→Velocity actual value	VAR	X	X
0x6071	→Target torque	VAR	X	X
0x6076	→Motor rated torque	VAR	X	X
0x6077	→Torque actual value	VAR	X	X
0x607A	→Target position	VAR	X	X
0x607B	→Position range limit	ARRAY	X	X

Continued on next page.



Index	Name	Object code	CANopen	EtherCAT
0x607D	→Software position limit	ARRAY	X	X
0x607F	→Max profile velocity	VAR	X	X
0x6080	→Max motor speed	VAR	X	X
0x6081	→Profile velocity	VAR	X	X
0x6083	→Profile acceleration	VAR	X	X
0x6084	→Profile deceleration	VAR	X	X
0x6085	→Quick stop deceleration	VAR	X	X
0x6086	→Motion profile type	VAR	X	X
0x6098	→Homing method	VAR	X	X
0x6099	→Homing speeds	ARRAY	X	X
0x609A	→Homing acceleration	VAR	X	X
0x60A8	→SI unit position	VAR	X	X
0x60A9	→SI unit velocity	VAR	X	X
0x60AA	→SI unit acceleration	VAR	X	X
0x60B0	→Position offset	VAR	X	X
0x60B1	→Velocity offset	VAR	X	X
0x60B2	→Torque offset	VAR	X	X
0x60B8	→Touch probe function	VAR	X	X
0x60B9	→Touch probe status	VAR	X	X
0x60BA	→Touch probe 1 positive edge	VAR	X	X
0x60BB	→Touch probe 1 negative edge	VAR	X	X
0x60C2	→Interpolation time period	RECORD	X	X
0x60C5	→Max acceleration	VAR	X	X
0x60D0	→Touch probe source	ARRAY	X	X
0x60D5	→Touch probe 1 positive edge counter	VAR	X	X
0x60D6	→Touch probe 1 negative edge counter	VAR	X	X
0x60E3	→Supported homing methods	ARRAY	X	X
0x60E4	→Additional position actual values	ARRAY	X	X
0x60E5	→Additional velocity actual values	ARRAY	X	X
0x60F4	→Following error actual value	VAR	X	X
0x60FD	→Digital inputs	VAR	X	X
0x60FE	→Digital outputs	ARRAY	X	X
0x60FF	→Target velocity	VAR	X	X
0x6402	→Motor type	VAR	X	X
0x6502	→Supported drive modes	VAR	X	X
0xF000	→Modular device profile	RECORD		X
0xF030	→Configured module ident list	ARRAY		X
0xF050	→Detected module ident list	ARRAY		X

Table 6-59 Object Dictionary (overview)

## 6.2 Objects



### **Annotation**

Items marked with an asterisk (\*) refer to internal values.

### 6.2.1 Device type

Describes the device type. The lower word stands for the supported device profile number. The value 0x0192 (402) means that the device follows CiA 402 “CANopen device profile for drives and motion control”. The higher word holds information on the drive type. The value 0x0002 means that the drive is a servo drive.

Name	Device type
Index	0x1000
Subindex	0x00
Data type	UNSIGNED32
Access type	RO
Default value	0x00020192
Value range	–
PDO mapping	NO
Backup	NO

### 6.2.2 Error register

The error register for the device. The device maps internal errors in this byte.

Name	Error register
Index	0x1001
Subindex	0x00
Data type	UNSIGNED8
Access type	RO
Default value	0
Value range	–
PDO mapping	NO
Backup	NO

Bit	Description
7	Motion error
6	reserved (always 0)
5	Device profile-specific
4	Communication error
3	Temperature error
2	Voltage error
1	Current error
0	Generic error

Table 6-60 Error register bits

## 6.2.3 Error history

The object is only available if the active fieldbus is CANopen.

Holds errors that have occurred on the device and have been signaled via the emergency object.

Name	Error history
Index	0x1003
Object code	ARRAY
Highest subindex supported	5

### 6.2.3.1 Number of errors

Contains the number of actual errors that are recorded in the array starting at subindex 1. Writing a "0" (zero) deletes the error history (empties the array). Values higher than "0" (zero) are not allowed to write.

Name	Number of errors
Index	0x1003
Subindex	0x00
Data type	UNSIGNED8
Access type	RW
Default value	0
Value range	0 5
PDO mapping	NO
Backup	NO

### 6.2.3.2 Error history

Every new error code is stored at subindex 1, the older ones move down the list. The error numbers compose of a 16-bit error code and 16-bit additional error information on higher word.

Errors without a device state change are marked with 0x8000 (bit31) in additional error information.

Names	Error history 1 Error history 2 Error history 3 Error history 4 Error history 5	
Index	0x1003	
Subindex	0x01...0x05	
Data type	UNSIGNED32	
Access type	RO	
Default value	–	
Value range	–	–
PDO mapping	NO	
Backup	NO	

BYTE	Value	Description
31	0	Error
	1	Warning only (without effect on device states)
30...16	0	Reserved
15...0	Error code	Device error code

Table 6-61 Error history structure

### 6.2.4 COB-ID SYNC

**The object is only available if the active fieldbus is CANopen.**

The Communication Object Identifier of the synchronization object.

Name	COB-ID SYNC	
Index	0x1005	
Subindex	0x00	
Data type	UNSIGNED32	
Access type	CONST	
Default value	0x00000080	
Value range	–	–
PDO mapping	NO	
Backup	NO	

### 6.2.5 *Manufacturer device name*

Holds the manufacturer device name.

Name	Manufacturer device name	
Index	0x1008	
Subindex	0x00	
Data type	VISIBLE_STRING	
Access type	RO	
Default value	EPOS4	
Value range	–	–
PDO mapping	NO	
Backup	NO	

## 6.2.6 Store parameters

Controls saving of configuration parameters in a non-volatile memory.

Name	Store parameters
Index	0x1010
Object code	ARRAY
Highest subindex supported	1

In order to avoid storage of parameters by mistake, storage should only be executed when a specific signature is written to the respective subindex.

On read access, the device will always return the value 0x00000001.

BYTE	MSB			LSB
Character	'e'	'v'	'a'	's'
Hex value	0x65	0x76	0x61	0x73

Table 6-62 Store parameters signature

On read access, the device will always return the value 0x00000001 since the device can only store the parameters on command.

Bit	RW	Description
31...2	X	reserved
1 (auto)	1	The device saves parameters autonomously
	0	The device does not save parameters autonomously
0 (cmd)	1	The device saves parameters on command
	0	The device does not save parameters on command

Table 6-63 Store parameters state

### 6.2.6.1 Save all parameters

All parameters of the controller will be stored in a non-volatile memory if the code "save" is written to the object.

Name	Save all parameters
Index	0x1010
Subindex	0x01
Data type	UNSIGNED32
Access type	RW
Default value	0x00000001
Value range	→ Table 6-62
PDO mapping	NO
Backup	NO

## 6.2.7 Restore default parameters

Configuration parameters are restored to the default values.

Restoring the default parameters is permitted in NMT state «Pre-Operational» and device state «Power Disable», only. The default values are only set valid after the device is reset or power cycled.

Name	Restore default parameters
Index	0x1011
Object code	ARRAY
Highest subindex supported	4

In order to avoid restoring of default parameters by mistake, restoring should only be executed when a specific signature is written to the respective subindex.

On read access, the device will always return the value 0x00000001.

BYTE	MSB			LSB
Character	'd'	'a'	'o'	'l'
Hex value	0x64	0x61	0x6F	0x6C

Table 6-64 Restore default parameters signature

### 6.2.7.1 Restore all default parameters

All parameters of the controller will be stored in a non-volatile memory, if the code "load" is written to the object. Only permitted if all axes of the controller are in device state «Power Disable».

Name	Restore all default parameters
Index	0x1011
Subindex	0x01
Data type	UNSIGNED32
Access type	RW
Default value	0x00000001
Value range	→ Table 6-64
PDO mapping	NO
Backup	NO

## 6.2.8 COB-ID EMCY

**The object is only available if the active fieldbus is CANopen.**

The Communication Object Identifier of the emergency object.

Name	COB-ID EMCY
Index	0x1014
Subindex	0x00
Data type	UNSIGNED32
Access type	RO
Default value	0x00000080 + Node-ID
Value range	– –
PDO mapping	NO
Backup	NO

## 6.2.9 Consumer heartbeat time

**The object is only available if the active fieldbus is CANopen.**

Defines the expected cycle time of the heartbeat. The heartbeat times are higher than the corresponding producer heartbeat times configured on the CANopen device that produces this heartbeat. Monitoring starts after reception of the first heartbeat. The time is given as multiple of 1 ms.

If the heartbeat time is “0” (zero), the Node-ID can also be set to “0” (zero). The object entry will not be used.

We recommend to set the consumer heartbeat time value at least 20 ms higher than the time value of the producer.

Typically, the master (or another slave) produces the heartbeat. Therefore, it does not make sense nor even may work properly if the producer Node-ID configured in this object is equal to the Node-ID in use by this device.

In case of a CAN heartbeat error, the device behavior can be defined with →“Communication error” on page 6-80.

Related object: →“Producer heartbeat time” on page 6-77

Name	Consumer heartbeat time
Index	0x1016
Object code	ARRAY
Highest subindex supported	2

### 6.2.9.1 Consumer n heartbeat time

Names	Consumer 1 heartbeat time Consumer 2 heartbeat time
Index	0x1016
Subindex	0x01...0x02
Data type	UNSIGNED32
Access type	RW
Default value	0
Value range	→Table 6-65
PDO mapping	NO
Backup	YES

Bit 31...24	Bit 23...16	Bit 15...0
reserved (0)	Node-ID	heartbeat time

Table 6-65 Consumer heartbeat time – Structure



### 6.2.10 *Producer heartbeat time*

The object is only available if the active fieldbus is CANopen.

Defines the cycle time of the heartbeat. The producer heartbeat time "0" (zero) will not be used. The time must be a multiple of 1 ms.

Name	Producer heartbeat time	
Index	0x1017	
Subindex	0x00	
Data type	UNSIGNED16	
Access type	RW	
Default value	0	
Value range	–	–
PDO mapping	NO	
Backup	YES	

### 6.2.11 *Identity object*

Provides general identification information on the device.

Name	Identity object	
Index	0x1018	
Object code	RECORD	
Highest subindex supported	4	

#### 6.2.11.1 *Vendor ID*

Unique "maxon motor ag" vendor identification defined by CiA.

Name	Vendor ID	
Index	0x1018	
Subindex	0x01	
Data type	UNSIGNED32	
Access type	RO	
Default value	0x000000FB	
Value range	–	–
PDO mapping	NO	
Backup	NO	

### 6.2.11.2 Product code

The high word contains the hardware version. The low word contains the application number.

Name	Product code
Index	0x1018
Subindex	0x02
Data type	UNSIGNED32
Access type	RO
Default value	–
Value range	–
PDO mapping	NO
Backup	NO

Hardware version	Hardware
0x6A50	EPOS4 Disk 60/8 CAN EPOS4 Disk 60/8 EtherCAT
0x6B50	EPOS4 Disk 60/12 CAN EPOS4 Disk 60/12 CAN SSC EPOS4 Disk 60/12 EtherCAT EPOS4 Disk 60/12 EtherCAT SSC
0x6850	EPOS4 Micro 24/5 CAN
0x6950	EPOS4 Micro 24/5 EtherCAT EPOS4 Compact 24/5 EtherCAT 3-axes
0x6050	EPOS4 Module 24/1.5 EPOS4 Compact 24/1.5 CAN EPOS4 Compact 24/1.5 EtherCAT
0x6150	EPOS4 Module 50/5 EPOS4 Compact 50/5 CAN EPOS4 Compact 50/5 EtherCAT
0x6551	EPOS4 Module 50/8 EPOS4 Compact 50/8 CAN EPOS4 Compact 50/8 EtherCAT
0x6552	EPOS4 Module 50/15 EPOS4 Compact 50/15 CAN EPOS4 Compact 50/15 EtherCAT
0x6350	EPOS4 50/5
0x6450	EPOS4 70/15

Table 6-66 Definition of hardware version

**6.2.11.3 Revision number**

The high word contains the software version. The low word contains the application version.

Name	Revision number	
Index	0x1018	
Subindex	0x03	
Data type	UNSIGNED32	
Access type	RO	
Default value	–	
Value range	–	–
PDO mapping	NO	
Backup	NO	

**6.2.11.4 Serial number**

Contains the last 8 digits of the device serial number.

Related object: →“Serial number complete” on page 6-131

Name	Serial number	
Index	0x1018	
Subindex	0x04	
Data type	UNSIGNED32	
Access type	RO	
Default value	–	
Value range	–	–
PDO mapping	NO	
Backup	NO	

## 6.2.12 Error behavior

The object is only available if the active fieldbus is CANopen.

Allows to define the device behavior in case of a certain error.

Name	Error behavior
Index	0x1029
Object code	ARRAY
Highest subindex supported	1

### 6.2.12.1 Communication error

Defines the device behavior in case of a CAN heartbeat error.

Name	Communication error	
Index	0x1029	
Subindex	0x01	
Data type	UNSIGNED8	
Access type	RW	
Default value	0x00	
Value range	0x00	0x01
PDO mapping	NO	
Backup	YES	

Value	Description
0x00	Change to NMT state Pre-operational (only if currently in NMT state Operational)
0x01	No change of NMT state

Table 6-67 Error behavior in case of CAN heartbeat error

## 6.2.13 Diagnosis History

**The object is only available if the active fieldbus is EtherCAT.**

Allows the EtherCAT master to access the latest diagnosis messages. Up to maximal five diagnosis messages can be accessed.

In case of an error, the corresponding message will be displayed in «TwinCAT» (tab “Diag History”) and in «EPOS Studio». The error may be cleared by writing the value 0x80 to the →“Controlword” on page 6-221.

Name	Diagnosis History
Index	0x10F3
Object code	RECORD
Highest subindex supported	10

### 6.2.13.1 Maximum messages

Represents the number of diagnosis messages that can be stored in the diagnosis history (subindex 6 onwards).

Name	Maximum messages	
Index	0x10F3	
Subindex	0x01	
Data type	UNSIGNED8	
Access type	RO	
Default value	5	
Value range	5	5
PDO mapping	NO	
Backup	NO	

### 6.2.13.2 Newest message

The subindex of the latest diagnosis message (6...255).

Name	Newest message	
Index	0x10F3	
Subindex	0x02	
Data type	UNSIGNED8	
Access type	RO	
Default value	0	
Value range	0, 6	10
PDO mapping	NO	
Backup	NO	

### 6.2.13.3 *Newest acknowledged message*

Name	Newest acknowledged message	
Index	0x10F3	
Subindex	0x03	
Data type	UNSIGNED8	
Access type	RW	
Default value	0	
Value range	0	255
PDO mapping	NO	
Backup	NO	

Bit	RW	Description
>[SI0]...255	W	SDO abort with codes 0x06090030 (value range of parameter exceeded)
6...[SI0]	W	Messages are acknowledged
5...1	W	The Slave returns SDO abort with codes 0x06090030 (value range of parameter exceeded)
0	R	When the message queue will be overwritten, the Slave sets SI3 to "0" (zero)
	W	The Slave will clear all messages

Table 6-68 Newest acknowledged message – Read/Write bits

### 6.2.13.4 *New messages available*

Name	New messages available	
Index	0x10F3	
Subindex	0x04	
Data type	BOOLEAN	
Access type	RO	
Default value	0	
Value range	0: no unacknowledged message	1: diagnosis messages are available that can be acknowledged (SI2 <> SI3)
PDO mapping	YES	
Backup	NO	

### 6.2.13.5 Flags

Flags to control the diagnosis messages for sending/storing. The device supports the functionality for bit2 warning messages only.

Name	Flags	
Index	0x10F3	
Subindex	0x05	
Data type	UNSIGNED16	
Access type	RW	
Default value	0	
Value range	0	15
PDO mapping	NO	
Backup	NO	

Bit		RW	Description
15...6	–	–	reserved
5	1	RO	<ul style="list-style-type: none"> <li>In Overwrite Mode: Unacknowledged messages have been overwritten; SI3 is set to “0” (zero)</li> <li>In Acknowledge Mode: Buffer is full with unacknowledged messages, new messages are discarded</li> </ul>
4	0	(W)	Overwrite Mode – old messages are overwritten if buffer is full
	1		Acknowledge Mode – new messages only overwrites older ones if before acknowledged
3	0	(W)	Error messages are stored in the diagnosis message queue
	1		Error messages will not be stored in the diagnosis message queue
2	0	W	Warning messages are stored in the diagnosis message queue
	1		Warning messages will not be stored in the diagnosis message queue
1	0	W	Info messages are stored in the diagnosis message queue
	1		Info messages will not be stored in the diagnosis message queue
0	0	(W)	Default if device does not support Emergency Sending
	1		New diagnosis messages are sent as Emergency Message

Table 6-69 Flags – Read/Write bits

### 6.2.13.6 Diagnosis message

The buffer can store up to 5 diagnosis messages. The first message is stored in subindex 6, the next in subindex 7, and so on. Once the diagnosis message queue is full, the Slave overwrites subindex 6, then subindex 7, and so on, thus enabling the Master to access the most recent messages).

The Diagnosis message contains the parameters shown in →Table 6-70.

Names	Diagnosis message 1 Diagnosis message 2 Diagnosis message 3 Diagnosis message 4 Diagnosis message 5	
Index	0x10F3	
Subindex	0x06...0x0A	
Data type	OCTET_STRING	
Access type	RO	
Default value	–	
Value range	–	–
PDO mapping	NO	
Backup	NO	

Parameter	Data type	Description	
Diag Code	UNSIGNED32	Bit 0...15 = 0xE000	Bit 16...31: Emergency Error Code
Flags	UNSIGNED16	Bit 0...3	Diag type:
			1
		2	Error message
		Bit 4...15	0x00
Text ID	UNSIGNED16	Text ID as reference to Diagnosis text as defined in the ESI file	
		0	No Text ID
		1...65535	Text ID reference to ESI file
Time Stamp	UNSIGNED64	Time Stamp in ns	
		0	No time stamp

Table 6-70 Diagnosis messages



## 6.2.14 SDO server parameter

The object is only available if the active fieldbus is CANopen.

Name	SDO server parameter
Index	0x1200
Object code	RECORD
Highest subindex supported	2

### 6.2.14.1 COB-ID SDO client to server

Shows the Communication Object Identifier for service data objects from master to device.

Related object: →“Producer heartbeat time” on page 6-77

Name	COB-ID SDO client to server
Index	0x1200
Subindex	0x01
Data type	UNSIGNED32
Access type	RO
Default value	0x00000600 + Node-ID
Value range	–
PDO mapping	NO
Backup	NO

### 6.2.14.2 COB-ID SDO server to client

Shows the Communication Object Identifier for service data objects from device to master.

Related object: →“Node-ID” on page 6-126

Name	COB-ID SDO server to client
Index	0x1200
Subindex	0x02
Data type	UNSIGNED32
Access type	RO
Default value	0x00000580 + Node-ID
Value range	–
PDO mapping	NO
Backup	NO

## 6.2.15 Receive PDO 1 parameter

The object is only available if the active fieldbus is CANopen.

Name	Receive PDO 1 parameter
Index	0x1400
Object code	RECORD
Highest subindex supported	2

### 6.2.15.1 COB-ID used by RxPDO 1

The Communication Object Identifier of receive process data object.

Name	COB-ID used by RxPDO 1
Index	0x1400
Subindex	0x01
Data type	UNSIGNED32
Access type	RW
Default value	0x00000200 + Node-ID
Value range	→ Table 6-71 and Table 6-72
PDO mapping	NO
Backup	YES

Bit 31	Bit 30	Bit 29...11	Bit 10...0
valid	RTR	0 (CAN base frame)	11-bit CAN ID

Table 6-71 COB-ID used by RxPDO – Structure

Bit	Description	
valid	0b	PDO exists / PDO is valid
	1b	PDO does not exist / PDO is not valid
RTR	0b	RTR allowed on this PDO
	1b	no RTR allowed on this PDO
11-bit Can ID	Value range	0x181...0x57F 0x000 (if valid = 1)

Table 6-72 COB-ID used by RxPDO – Description

### 6.2.15.2 *Transmission type RxPDO 1*

Describes the PDO's communication principle.

Name	Transmission type RxPDO 1	
Index	0x1400	
Subindex	0x02	
Data type	UNSIGNED8	
Access type	RW	
Default value	255	
Value range	1:synchronous 255:asynchronous	-
PDO mapping	NO	
Backup	YES	

## 6.2.16 Receive PDO 2 parameter

The object is only available if the active fieldbus is CANopen.

Name	Receive PDO 2 parameter
Index	0x1401
Object code	RECORD
Highest subindex supported	2

### 6.2.16.1 COB-ID used by RxPDO 2

The Communication Object Identifier of receive process data object.

Name	COB-ID used by RxPDO 2
Index	0x1401
Subindex	0x01
Data type	UNSIGNED32
Access type	RW
Default value	0x00000300 + Node-ID
Value range	→ Table 6-71 and Table 6-72
PDO mapping	NO
Backup	YES

### 6.2.16.2 Transmission type RxPDO 2

Describes the PDO's communication principle.

Name	Transmission type RxPDO 2	
Index	0x1401	
Subindex	0x02	
Data type	UNSIGNED8	
Access type	RW	
Default value	255	
Value range	1:synchronous 255:asynchronous	–
PDO mapping	NO	
Backup	YES	

### 6.2.17 Receive PDO 3 parameter

The object is only available if the active fieldbus is CANopen.

Name	Receive PDO 3 parameter
Index	0x1402
Object code	RECORD
Highest subindex supported	2

#### 6.2.17.1 COB-ID used by RxPDO 3

The Communication Object Identifier of receive process data object.

Name	COB-ID used by RxPDO 3
Index	0x1402
Subindex	0x01
Data type	UNSIGNED32
Access type	RW
Default value	0x00000400 + Node-ID
Value range	→ Table 6-71 and Table 6-72
PDO mapping	NO
Backup	YES

#### 6.2.17.2 Transmission type RxPDO 3

Describes the PDO's communication principle.

Name	Transmission type RxPDO 3
Index	0x1402
Subindex	0x02
Data type	UNSIGNED8
Access type	RW
Default value	255
Value range	1:synchronous 255:asynchronous
PDO mapping	NO
Backup	YES

## 6.2.18 Receive PDO 4 parameter

The object is only available if the active fieldbus is CANopen.

Name	Receive PDO 4 parameter
Index	0x1403
Object code	RECORD
Highest subindex supported	2

### 6.2.18.1 COB-ID used by RxPDO 4

The Communication Object Identifier of receive process data object.

Name	COB-ID used by RxPDO 4
Index	0x1403
Subindex	0x01
Data type	UNSIGNED32
Access type	RW
Default value	0x00000500 + Node-ID
Value range	→ Table 6-71 and Table 6-72
PDO mapping	NO
Backup	YES

### 6.2.18.2 Transmission type RxPDO 4

Describes the PDO's communication principle.

Name	Transmission type RxPDO 4	
Index	0x1403	
Subindex	0x02	
Data type	UNSIGNED8	
Access type	RW	
Default value	255	
Value range	1:synchronous 255:asynchronous	–
PDO mapping	NO	
Backup	YES	

## 6.2.19 Receive PDO 1 mapping

Contains the process data mapping parameters of RxPDO1. Mapping of objects is required to enable PDO processing. Subindex 0 represents the number of mapped objects. Subindex 0x01...0x0C represent the mapped objects whereby the value describes the corresponding index, subindex, and length. The value for the length (in bits) is used to calculate the total mapping length. The maximal allowed length for all mapped objects is as follows:

- CANopen 8 Byte
- EtherCAT 40 Byte

Write access is only permitted in NMT state «Pre-Operational».

The structure for the mapped object in subindex 0x01...0x0C is as follows:

Bit 31...16	Bit 15...8	Bit 7...0
Index	Subindex	Length

Table 6-73 Receive PDO mapping – Structure of mapped object

To be able to change the PDO mapping, the following procedure must be performed:

- Write the value "0" (zero) to subindex 0x00 (disable PDO).
- Modify the desired objects in subindex 0x01...0x0n.
- Write the desired number of mapped objects to subindex 0x00.

Name	Receive PDO 1 mapping
Index	0x1600
Object code	RECORD
Highest subindex supported	12

### 6.2.19.1 Number of mapped objects in RxPDO 1

Name	Number of mapped objects in RxPDO 1	
Index	0x1600	
Subindex	0x00	
Data type	UNSIGNED8	
Access type	RW	
Default value	1	
Value range	0 (PDO disabled)	1...12 (1...12 objects are mapped)
PDO mapping	NO	
Backup	YES	

### 6.2.19.2 1st mapped object in RxPDO 1

Objects with subindex 0x02...0x0C follow the same description as the object with subindex 1.

Name	1st mapped object in RxPDO 1	
Index	0x1600	
Subindex	0x01	
Data type	UNSIGNED32	
Access type	RW	
Default value	0x60400010	
Value range	–	–
PDO mapping	NO	
Backup	YES	

#### DEFAULT VALUES FOR MAPPED OBJECTS IN RXPDO1

Mapped object	Subindex	Default value	
1 <sup>st</sup>	0x01	0x60400010	→Controlword
2 <sup>nd</sup>	0x02	0x00000000	no object mapped
3 <sup>rd</sup>	0x03	0x00000000	no object mapped
4 <sup>th</sup>	0x04	0x00000000	no object mapped
5 <sup>th</sup>	0x05	0x00000000	no object mapped
6 <sup>th</sup>	0x06	0x00000000	no object mapped
7 <sup>th</sup>	0x07	0x00000000	no object mapped
8 <sup>th</sup>	0x08	0x00000000	no object mapped
9 <sup>th</sup>	0x09	0x00000000	no object mapped
10 <sup>th</sup>	0x0A	0x00000000	no object mapped
11 <sup>th</sup>	0x0B	0x00000000	no object mapped
12 <sup>th</sup>	0x0C	0x00000000	no object mapped

Table 6-74 Receive PDO 1 mapping



## 6.2.20 Receive PDO 2 mapping

Contains the process data mapping parameters of RxPDO2. For a detailed description applicable by analogy → “Receive PDO 1 mapping” on page 6-91.

Name	Receive PDO 2 mapping
Index	0x1601
Object code	RECORD
Highest subindex supported	12

### 6.2.20.1 Number of mapped objects in RxPDO 2

Name	Number of mapped objects in RxPDO 2	
Index	0x1601	
Subindex	0x00	
Data type	UNSIGNED8	
Access type	RW	
Default value	2	
Value range	0 (PDO disabled)	1...12 (1...12 objects are mapped)
PDO mapping	NO	
Backup	YES	

### 6.2.20.2 1st mapped object in RxPDO 2

Objects with subindex 0x02...0x12 follow the same description as the object with subindex 1.

Name	1st mapped object in RxPDO 2	
Index	0x1601	
Subindex	0x01	
Data type	UNSIGNED32	
Access type	RW	
Default value	0x60400010	
Value range	–	–
PDO mapping	NO	
Backup	YES	

Continued on next page.

### DEFAULT VALUES FOR MAPPED OBJECTS IN RXPDO2

Mapped object	Subindex	Default value	
1 <sup>st</sup>	0x01	0x60400010	→Controlword
2 <sup>nd</sup>	0x02	0x60600008	→Modes of operation
3 <sup>rd</sup>	0x03	0x00000000	no object mapped
4 <sup>th</sup>	0x04	0x00000000	no object mapped
5 <sup>th</sup>	0x05	0x00000000	no object mapped
6 <sup>th</sup>	0x06	0x00000000	no object mapped
7 <sup>th</sup>	0x07	0x00000000	no object mapped
8 <sup>th</sup>	0x08	0x00000000	no object mapped
9 <sup>th</sup>	0x09	0x00000000	no object mapped
10 <sup>th</sup>	0x0A	0x00000000	no object mapped
11 <sup>th</sup>	0x0B	0x00000000	no object mapped
12 <sup>th</sup>	0x0C	0x00000000	no object mapped

Table 6-75 Receive PDO 2 mapping

## 6.2.21 Receive PDO 3 mapping

Contains the process data mapping parameters of RxPDO3. For a detailed description applicable by analogy →“Receive PDO 1 mapping” on page 6-91.

Name	Receive PDO 3 mapping
Index	0x1602
Object code	RECORD
Highest subindex supported	12

### 6.2.21.1 Number of mapped objects in RxPDO 3

Name	Number of mapped objects in RxPDO 3	
Index	0x1602	
Subindex	0x00	
Data type	UNSIGNED8	
Access type	RW	
Default value	2	
Value range	0 (PDO disabled)	1...12 (1...12 objects are mapped)
PDO mapping	NO	
Backup	YES	

**6.2.21.2 1st mapped object in RxPDO 3**

Objects with subindex 0x02...0x12 follow the same description as the object with subindex 1.

Name	1st mapped object in RxPDO 3	
Index	0x1602	
Subindex	0x01	
Data type	UNSIGNED32	
Access type	RW	
Default value	0x60400010	
Value range	–	–
PDO mapping	NO	
Backup	YES	

**DEFAULT VALUES FOR MAPPED OBJECTS IN RXPDO3**

Mapped object	Subindex	Default value	
1 <sup>st</sup>	0x01	0x60400010	→Controlword
2 <sup>nd</sup>	0x02	0x607A0020	→Target position
3 <sup>rd</sup>	0x03	0x00000000	no object mapped
4 <sup>th</sup>	0x04	0x00000000	no object mapped
5 <sup>th</sup>	0x05	0x00000000	no object mapped
6 <sup>th</sup>	0x06	0x00000000	no object mapped
7 <sup>th</sup>	0x07	0x00000000	no object mapped
8 <sup>th</sup>	0x08	0x00000000	no object mapped
9 <sup>th</sup>	0x09	0x00000000	no object mapped
10 <sup>th</sup>	0x0A	0x00000000	no object mapped
11 <sup>th</sup>	0x0B	0x00000000	no object mapped
12 <sup>th</sup>	0x0C	0x00000000	no object mapped

Table 6-76 Receive PDO 3 mapping

## 6.2.22 Receive PDO 4 mapping

Contains the process data mapping parameters of RxPDO4. For a detailed description applicable by analogy → “Receive PDO 1 mapping” on page 6-91.

Name	Receive PDO 4 mapping
Index	0x1603
Object code	RECORD
Highest subindex supported	12

### 6.2.22.1 Number of mapped objects in RxPDO 4

Name	Number of mapped objects in RxPDO 4	
Index	0x1603	
Subindex	0x00	
Data type	UNSIGNED8	
Access type	RW	
Default value	2	
Value range	0 (PDO disabled)	1...12 (1...12 objects are mapped)
PDO mapping	NO	
Backup	YES	

### 6.2.22.2 1st mapped object in RxPDO 4

Objects with subindex 0x02...0x12 follow the same description as the object with subindex 1.

Name	1st mapped object in RxPDO 4	
Index	0x1603	
Subindex	0x01	
Data type	UNSIGNED32	
Access type	RW	
Default value	0x60400010	
Value range	–	–
PDO mapping	NO	
Backup	YES	

Continued on next page.

**DEFAULT VALUES FOR MAPPED OBJECTS IN RXPDO4**

Mapped object	Subindex	Default value	
1 <sup>st</sup>	0x01	0x60400010	→Controlword
2 <sup>nd</sup>	0x02	0x60FF0020	→Target velocity
3 <sup>rd</sup>	0x03	0x00000000	no object mapped
4 <sup>th</sup>	0x04	0x00000000	no object mapped
5 <sup>th</sup>	0x05	0x00000000	no object mapped
6 <sup>th</sup>	0x06	0x00000000	no object mapped
7 <sup>th</sup>	0x07	0x00000000	no object mapped
8 <sup>th</sup>	0x08	0x00000000	no object mapped
9 <sup>th</sup>	0x09	0x00000000	no object mapped
10 <sup>th</sup>	0x0A	0x00000000	no object mapped
11 <sup>th</sup>	0x0B	0x00000000	no object mapped
12 <sup>th</sup>	0x0C	0x00000000	no object mapped

Table 6-77 Receive PDO 4 mapping

**6.2.23 Transmit PDO 1 parameter**

The object is only available if the active fieldbus is CANopen.

Name	Transmit PDO 1 parameter
Index	0x1800
Object code	RECORD
Highest subindex supported	3

**6.2.23.1 COB-ID used by TxPDO 1**

The Communication Object Identifier of transmit process data object.

Name	COB-ID used by TxPDO 1
Index	0x1800
Subindex	0x01
Data type	UNSIGNED32
Access type	RW
Default value	0x40000180 + Node-ID
Value range	→Table 6-78 and Table 6-79
PDO mapping	NO
Backup	YES

Continued on next page.

Bit 31	Bit 30	Bit 29...11	Bit 10...0
valid	RTR	0 (CAN base frame)	11-bit CAN ID

Table 6-78 COB-ID used by TxPDO – Structure

Bit	Description	
valid	0b	PDO exists / PDO is valid
	1b	PDO does not exist / PDO is not valid
RTR	0b	RTR allowed on this PDO
	1b	no RTR allowed on this PDO
11-bit Can ID	11-bit CAN ID of the CAN base frame	
	Value range	0x181...0x57F 0x000 (if valid = 1)

Table 6-79 COB-ID used by TxPDO – Description

### 6.2.23.2 *Transmission type TxPDO 1*

Describes the PDO's communication principle.

With transmission type 253, the PDO is only transmitted on remote transmission request (RTR). With transmission type 255, the PDO is transmitted if the data changes its value. Therefore, the inhibit time defines a minimum interval.

Name	Transmission type TxPDO 1	
Index	0x1800	
Subindex	0x02	
Data type	UNSIGNED8	
Access type	RW	
Default value	255	
Value range	1: synchronous 253: asynchronous on RTR only 255: asynchronous	–
PDO mapping	NO	
Backup	YES	

### 6.2.23.3 *Inhibit time TxPDO 1*

Represents the minimum interval for event-triggered PDO transmission. The value is defined as multiple of 100  $\mu$ s.

Event-triggered PDOs can generate immense loads on both CAN bus and device especially if the inhibit time of different PDOs is set to a small value.

Name	Inhibit time TxPDO 1	
Index	0x1800	
Subindex	0x03	
Data type	UNSIGNED16	
Access type	RW	
Default value	10	
Value range	–	–
PDO mapping	NO	
Backup	YES	

## 6.2.24 *Transmit PDO 2 parameter*

The object is only available if the active fieldbus is CANopen.

Name	Transmit PDO 2 parameter	
Index	0x1801	
Object code	RECORD	
Highest subindex supported	3	

### 6.2.24.1 *COB-ID used by TxPDO 2*

The Communication Object Identifier of transmit process data object.

Name	COB-ID used by TxPDO 2	
Index	0x1801	
Subindex	0x01	
Data type	UNSIGNED32	
Access type	RW	
Default value	0xC0000280 + Node-ID	
Value range	→ Table 6-78 and Table 6-79	
PDO mapping	NO	
Backup	YES	

### 6.2.24.2 Transmission type TxPDO 2

Describes the PDO's communication principle.

With transmission type 253, the PDO is only transmitted on remote transmission request (RTR). With transmission type 255, the PDO is transmitted if the data changes its value. Therefore, the inhibit time defines a minimum interval.

Name	Transmission type TxPDO 2	
Index	0x1801	
Subindex	0x02	
Data type	UNSIGNED8	
Access type	RW	
Default value	255	
Value range	1: synchronous 253: asynchronous on RTR only 255: asynchronous	–
PDO mapping	NO	
Backup	YES	

### 6.2.24.3 Inhibit time TxPDO 2

Represents the minimum interval for event-triggered PDO transmission. The value is defined as multiple of 100  $\mu$ s.

Event-triggered PDOs can generate immense loads on both CAN bus and device especially if the inhibit time of different PDOs is set to a small value.

Name	Inhibit time TxPDO 2	
Index	0x1801	
Subindex	0x03	
Data type	UNSIGNED16	
Access type	RW	
Default value	10	
Value range	–	–
PDO mapping	NO	
Backup	YES	



## 6.2.25 Transmit PDO 3 parameter

The object is only available if the active fieldbus is CANopen.

Name	Transmit PDO 3 parameter
Index	0x1802
Object code	RECORD
Highest subindex supported	3

### 6.2.25.1 COB-ID used by TxPDO 3

The Communication Object Identifier of transmit process data object.

Name	COB-ID used by TxPDO 3
Index	0x1802
Subindex	0x01
Data type	UNSIGNED32
Access type	RW
Default value	0xC0000380 + Node-ID
Value range	→ Table 6-78 and Table 6-79
PDO mapping	NO
Backup	YES

### 6.2.25.2 Transmission type TxPDO 3

Describes the PDO's communication principle.

With transmission type 253, the PDO is only transmitted on remote transmission request (RTR). With transmission type 255, the PDO is transmitted if the data changes its value. Therefore, the inhibit time defines a minimum interval.

Name	Transmission type TxPDO 3	
Index	0x1802	
Subindex	0x02	
Data type	UNSIGNED8	
Access type	RW	
Default value	255	
Value range	1: synchronous 253: asynchronous on RTR only 255: asynchronous	–
PDO mapping	NO	
Backup	YES	

### 6.2.25.3 Inhibit time TxPDO 3

Represents the minimum interval for event-triggered PDO transmission. The value is defined as multiple of 100  $\mu$ s.

Event-triggered PDOs can generate immense loads on both CAN bus and device especially if the inhibit time of different PDOs is set to a small value.

Name	Inhibit time TxPDO 3	
Index	0x1802	
Subindex	0x03	
Data type	UNSIGNED16	
Access type	RW	
Default value	10	
Value range	–	–
PDO mapping	NO	
Backup	YES	

## 6.2.26 Transmit PDO 4 parameter

The object is only available if the active fieldbus is CANopen.

Name	Transmit PDO 4 parameter	
Index	0x1803	
Object code	RECORD	
Highest subindex supported	3	

### 6.2.26.1 COB-ID used by TxPDO 4

The Communication Object Identifier of transmit process data object.

Name	COB-ID used by TxPDO 4	
Index	0x1803	
Subindex	0x01	
Data type	UNSIGNED32	
Access type	RW	
Default value	0xC0000480 + Node-ID	
Value range	→ Table 6-78 and Table 6-79	
PDO mapping	NO	
Backup	YES	

**6.2.26.2 Transmission type TxPDO 4**

Describes the PDO's communication principle.

With transmission type 253, the PDO is only transmitted on remote transmission request (RTR). With transmission type 255, the PDO is transmitted if the data changes its value. Therefore, the inhibit time defines a minimum interval.

Name	Transmission type TxPDO 4	
Index	0x1803	
Subindex	0x02	
Data type	UNSIGNED8	
Access type	RW	
Default value	255	
Value range	1: synchronous 253: asynchronous on RTR only 255: asynchronous	–
PDO mapping	NO	
Backup	YES	

**6.2.26.3 Inhibit time TxPDO 4**

Represents the minimum interval for event-triggered PDO transmission. The value is defined as multiple of 100  $\mu$ s.

Event-triggered PDOs can generate immense loads on both CAN bus and device especially if the inhibit time of different PDOs is set to a small value.

Name	Inhibit time TxPDO 4	
Index	0x1803	
Subindex	0x03	
Data type	UNSIGNED16	
Access type	RW	
Default value	10	
Value range	–	–
PDO mapping	NO	
Backup	YES	

## 6.2.27 Transmit PDO 1 mapping

Contains the process data mapping parameters of TxPDO1. Mapping of objects is required to enable PDO processing. Subindex 0 represents the number of mapped objects. Subindex 0x01...0x0C represent the mapped objects whereby the value describes the corresponding index, subindex, and length. The value for the length (in bits) is used to calculate the total mapping length.

The maximal allowed length for all mapped objects is as follows:

- CANopen 8 Byte
- EtherCAT 40 Byte

Write access is only permitted in NMT state «Pre-Operational».

The structure for the mapped object in subindex 0x01...0x0C is as follows:

Bit 31...16	Bit 15...8	Bit 7...0
Index	Subindex	Length

Table 6-80 Transmit PDO mapping – Structure of mapped object

To be able to change the PDO mapping, the following procedure must be performed:

- a) Write the value "0" (zero) to subindex 0x00 (disable PDO).
- b) Modify the desired objects in subindex 0x01...0x0n.
- c) Write the desired number of mapped objects to subindex 0x00.

Name	Transmit PDO 1 mapping
Index	0x1A00
Object code	RECORD
Highest subindex supported	12

### 6.2.27.1 Number of mapped objects in TxPDO 1

Name	Number of mapped objects in TxPDO 1	
Index	0x1A00	
Subindex	0x00	
Data type	UNSIGNED8	
Access type	RW	
Default value	1	
Value range	0 (PDO disabled)	1...12 (1...12 objects are mapped)
PDO mapping	NO	
Backup	YES	

**6.2.27.2 1st mapped object in TxPDO 1**

Objects with subindex 0x02...0x0C follow the same description as the object with subindex 1.

Name	1st mapped object in TxPDO 1		
Index	0x1A00		
Subindex	0x01		
Data type	UNSIGNED32		
Access type	RW		
Default value	0x60410010		
Value range	–		–
PDO mapping	NO		
Backup	YES		

**DEFAULT VALUES FOR MAPPED OBJECTS IN TXPDO1**

Mapped object	Subindex	Default value	
1 <sup>st</sup>	0x01	0x60410010	→ Statusword
2 <sup>nd</sup>	0x02	0x00000000	no object mapped
3 <sup>rd</sup>	0x03	0x00000000	no object mapped
4 <sup>th</sup>	0x04	0x00000000	no object mapped
5 <sup>th</sup>	0x05	0x00000000	no object mapped
6 <sup>th</sup>	0x06	0x00000000	no object mapped
7 <sup>th</sup>	0x07	0x00000000	no object mapped
8 <sup>th</sup>	0x08	0x00000000	no object mapped
9 <sup>th</sup>	0x09	0x00000000	no object mapped
10 <sup>th</sup>	0x0A	0x00000000	no object mapped
11 <sup>th</sup>	0x0B	0x00000000	no object mapped
12 <sup>th</sup>	0x0C	0x00000000	no object mapped

Table 6-81 Transmit PDO 1 mapping

## 6.2.28 Transmit PDO 2 mapping

Contains the process data mapping parameters of TxPDO2. For a detailed description applicable by analogy → “Transmit PDO 1 mapping” on page 6-104.

Name	Transmit PDO 2 mapping
Index	0x1A01
Object code	RECORD
Highest subindex supported	12

### 6.2.28.1 Number of mapped objects in TxPDO 2

Name	Number of mapped objects in TxPDO 2	
Index	0x1A01	
Subindex	0x00	
Data type	UNSIGNED8	
Access type	RW	
Default value	2	
Value range	0 (PDO disabled)	1...12 (1...12 objects are mapped)
PDO mapping	NO	
Backup	YES	

### 6.2.28.2 1st mapped object in TxPDO 2

Objects with subindex 0x02...0x0C follow the same description as the object with subindex 1.

Name	1st mapped object in TxPDO 2	
Index	0x1A01	
Subindex	0x01	
Data type	UNSIGNED32	
Access type	RW	
Default value	0x60410010	
Value range	–	–
PDO mapping	NO	
Backup	YES	

Continued on next page.

**DEFAULT VALUES FOR MAPPED OBJECTS IN TXPDO2**

Mapped object	Subindex	Default value	
1 <sup>st</sup>	0x01	0x60410010	→ Statusword
2 <sup>nd</sup>	0x02	0x60610008	→ Modes of operation display
3 <sup>rd</sup>	0x03	0x00000000	no object mapped
4 <sup>th</sup>	0x04	0x00000000	no object mapped
5 <sup>th</sup>	0x05	0x00000000	no object mapped
6 <sup>th</sup>	0x06	0x00000000	no object mapped
7 <sup>th</sup>	0x07	0x00000000	no object mapped
8 <sup>th</sup>	0x08	0x00000000	no object mapped
9 <sup>th</sup>	0x09	0x00000000	no object mapped
10 <sup>th</sup>	0x0A	0x00000000	no object mapped
11 <sup>th</sup>	0x0B	0x00000000	no object mapped
12 <sup>th</sup>	0x0C	0x00000000	no object mapped

Table 6-82 Transmit PDO 2 mapping

**6.2.29 Transmit PDO 3 mapping**

Contains the process data mapping parameters of TxPDO3. For a detailed description applicable by analogy → “Transmit PDO 1 mapping” on page 6-104.

Name	Transmit PDO 3 mapping
Index	0x1A02
Object code	RECORD
Highest subindex supported	12

**6.2.29.1 Number of mapped objects in TxPDO 3**

Name	Number of mapped objects in TxPDO 3	
Index	0x1A02	
Subindex	0x00	
Data type	UNSIGNED8	
Access type	RW	
Default value	2	
Value range	0 (PDO disabled)	1...12 (1...12 objects are mapped)
PDO mapping	NO	
Backup	YES	

### 6.2.29.2 1st mapped object in TxPDO 3

Objects with subindex 0x02...0x0C follow the same description as the object with subindex 1.

Name	1st mapped object in TxPDO 3	
Index	0x1A02	
Subindex	0x01	
Data type	UNSIGNED32	
Access type	RW	
Default value	0x60410010	
Value range	–	–
PDO mapping	NO	
Backup	YES	

#### DEFAULT VALUES FOR MAPPED OBJECTS IN TXPDO3

Mapped object	Subindex	Default value	
1 <sup>st</sup>	0x01	0x60410010	→ Statusword
2 <sup>nd</sup>	0x02	0x60640020	→ Position actual value
3 <sup>rd</sup>	0x03	0x00000000	no object mapped
4 <sup>th</sup>	0x04	0x00000000	no object mapped
5 <sup>th</sup>	0x05	0x00000000	no object mapped
6 <sup>th</sup>	0x06	0x00000000	no object mapped
7 <sup>th</sup>	0x07	0x00000000	no object mapped
8 <sup>th</sup>	0x08	0x00000000	no object mapped
9 <sup>th</sup>	0x09	0x00000000	no object mapped
10 <sup>th</sup>	0x0A	0x00000000	no object mapped
11 <sup>th</sup>	0x0B	0x00000000	no object mapped
12 <sup>th</sup>	0x0C	0x00000000	no object mapped

Table 6-83 Transmit PDO 3 mapping



### 6.2.30 Transmit PDO 4 mapping

Contains the process data mapping parameters of TxPDO4. For a detailed description applicable by analogy → “Transmit PDO 1 mapping” on page 6-104.

Name	Transmit PDO 4 mapping
Index	0x1A03
Object code	RECORD
Highest subindex supported	12

#### 6.2.30.1 Number of mapped objects in TxPDO 4

Name	Number of mapped objects in TxPDO 4	
Index	0x1A03	
Subindex	0x00	
Data type	UNSIGNED8	
Access type	RW	
Default value	2	
Value range	0 (PDO disabled)	1...12 (1...12 objects are mapped)
PDO mapping	NO	
Backup	YES	

#### 6.2.30.2 1st mapped object in TxPDO 4

Objects with subindex 0x02...0x0C follow the same description as the object with subindex 1.

Name	1st mapped object in TxPDO 4	
Index	0x1A03	
Subindex	0x01	
Data type	UNSIGNED32	
Access type	RW	
Default value	0x60410010	
Value range	–	–
PDO mapping	NO	
Backup	YES	

Continued on next page.

## DEFAULT VALUES FOR MAPPED OBJECTS IN TXPDO4

Mapped object	Subindex	Default value	
1 <sup>st</sup>	0x01	0x60410010	→ Statusword
2 <sup>nd</sup>	0x02	0x606C0020	→ Velocity actual value
3 <sup>rd</sup>	0x03	0x00000000	no object mapped
4 <sup>th</sup>	0x04	0x00000000	no object mapped
5 <sup>th</sup>	0x05	0x00000000	no object mapped
6 <sup>th</sup>	0x06	0x00000000	no object mapped
7 <sup>th</sup>	0x07	0x00000000	no object mapped
8 <sup>th</sup>	0x08	0x00000000	no object mapped
9 <sup>th</sup>	0x09	0x00000000	no object mapped
10 <sup>th</sup>	0x0A	0x00000000	no object mapped
11 <sup>th</sup>	0x0B	0x00000000	no object mapped
12 <sup>th</sup>	0x0C	0x00000000	no object mapped

Table 6-84 Transmit PDO 4 mapping

### 6.2.31 SYNC manager communication type

The object is only available if the active fieldbus is EtherCAT.

The preconfigured read only object is used to read out the transfer mode of the EtherCAT Sync Manager's channels.

Name	SYNC manager communication type
Index	0x1C00
Object code	ARRAY
Highest subindex supported	4

#### 6.2.31.1 Number of used SYNC manager channels

Name	Number of used SYNC manager channels	
Index	0x1C00	
Subindex	0x00	
Data type	UNSIGNED8	
Access type	RO	
Default value	4	
Value range	4	4
PDO mapping	NO	
Backup	NO	

**6.2.31.2 Communication type SYNC channel 0**

Name	Communication type SYNC channel 0	
Index	0x1C00	
Subindex	0x01	
Data type	UNSIGNED8	
Access type	RO	
Default value	1: Mailbox Receive (Master → Slave)	
Value range	1	1
PDO mapping	NO	
Backup	NO	

**6.2.31.3 Communication type SYNC channel 1**

Name	Communication type SYNC channel 1	
Index	0x1C00	
Subindex	0x02	
Data type	UNSIGNED8	
Access type	RO	
Default value	2: Mailbox Receive (Master ← Slave)	
Value range	2	2
PDO mapping	NO	
Backup	NO	

**6.2.31.4 Communication type SYNC channel 2**

Name	Communication type SYNC channel 2	
Index	0x1C00	
Subindex	0x03	
Data type	UNSIGNED8	
Access type	RO	
Default value	3: Process Data Output (Master → Slave)	
Value range	3	3
PDO mapping	NO	
Backup	NO	

**6.2.31.5 Communication type SYNC channel 3**

Name	Communication type SYNC channel 3	
Index	0x1C00	
Subindex	0x04	
Data type	UNSIGNED8	
Access type	RO	
Default value	4: Process Data Output (Master ← Slave)	
Value range	4	4
PDO mapping	NO	
Backup	NO	

## 6.2.32 SYNC manager 2 PDO assignment

The object is only available if the active fieldbus is EtherCAT.

Used to configure a PDO assignment for Sync channel 2 (Master → Slave).

In order to change the value in object → 1st assigned RxPDO, object → Number of assigned RxPDOs must be set to zero first.

Write access is only permitted in NMT state «Pre-Operational».

Name	SYNC manager 2 PDO assignment
Index	0x1C12
Object code	ARRAY
Highest subindex supported	1

### 6.2.32.1 Number of assigned RxPDOs

Name	Number of assigned RxPDOs
Index	0x1C12
Subindex	0x00
Data type	UNSIGNED8
Access type	RW
Default value	1
Value range	0 (PDO disabled) 1
PDO mapping	NO
Backup	YES

### 6.2.32.2 1st assigned RxPDO

Name	1st assigned RxPDO
Index	0x1C12
Subindex	0x01
Data type	UNSIGNED16
Access type	RW
Default value	0x1600
Value range	0x1600 0x1603
PDO mapping	NO
Backup	YES

### 6.2.33 SYNC manager 3 PDO assignment

The object is only available if the active fieldbus is EtherCAT.

Used to configure a PDO assignment for Sync channel 2 (Master ← Slave).

In order to change the value in object → 1st assigned TxPDO, object → Number of assigned TxPDOs must be set to zero first.

Write access is only permitted in NMT state «Pre-Operational».

Name	SYNC manager 3 PDO assignment
Index	0x1C13
Object code	ARRAY
Highest subindex supported	1

#### 6.2.33.1 Number of assigned TxPDOs

Name	Number of assigned TxPDOs
Index	0x1C13
Subindex	0x00
Data type	UNSIGNED8
Access type	RW
Default value	1
Value range	0 (PDO disabled) 1
PDO mapping	NO
Backup	YES

#### 6.2.33.2 1st assigned TxPDO

Name	1st assigned TxPDO
Index	0x1C13
Subindex	0x01
Data type	UNSIGNED16
Access type	RW
Default value	0x1A00
Value range	0x1A00 0x1A03
PDO mapping	NO
Backup	YES

## 6.2.34 SYNC manager 2 parameter

The object is only available if the active fieldbus is EtherCAT.

Used to display the synchronization of the output parameters.

Name	SYNC manager 2 parameter
Index	0x1C32
Object code	RECORD
Highest subindex supported	32

### 6.2.34.1 Synchronization type

Displays the synchronization type of the output parameters.

Name	Synchronization type
Index	0x1C32
Subindex	0x01
Data type	UNSIGNED16
Access type	RO
Default value	Synchronous
Value range	→ Table 6-85
PDO mapping	NO
Backup	NO

Value	Description
0x0001	Synchronous: Synchronous (with SM2 event)
0x0002	Distributed clock Sync0: Synchronous with SYNC0 event

Table 6-85 SYNC mode output parameters

### 6.2.34.2 Cycle time

Displays the cycle time of the output parameters. In Sync Manager synchronous mode, the value is measured while in Distributed Clock synchronous mode, the value is taken from the SyncO cycle time register. The value is given in [ns].

Name	Cycle time
Index	0x1C32
Subindex	0x02
Data type	UNSIGNED32
Access type	RO
Default value	–
Value range	–
PDO mapping	NO
Backup	NO

**6.2.34.3 Synchronization types supported**

Displays the supported synchronization modes of the output parameters.

Name	Synchronization types supported	
Index	0x1C32	
Subindex	0x04	
Data type	UNSIGNED16	
Access type	RO	
Default value	–	
Value range	–	–
PDO mapping	NO	
Backup	NO	

Bit	Description
15...12	reserved
11	Fixed delay time (synchronization executed by hardware)
10...7	reserved
6, 5	Shift settings 00 = No output shift supported
4...2	DC mode supported 000 = No DC 001 = DC Sync0
1	Synchronous supported
0	FreeRun supported

Table 6-86 Synchronization types supported – Output parameters

**6.2.34.4 Minimum cycle time**

Displays the minimum cycle time of the output parameters. The value is given in [ns].

Name	Minimum cycle time	
Index	0x1C32	
Subindex	0x05	
Data type	UNSIGNED32	
Access type	RO	
Default value	1'000'000	
Value range	–	–
PDO mapping	NO	
Backup	NO	

#### 6.2.34.5 Calc and copy time

The time needed by the application controller to copy the process data from the Sync Manager to the local memory and to perform calculations, if necessary, before the data is sent to the process. The value is given in [ns].

Name	Calc and copy time
Index	0x1C32
Subindex	0x06
Data type	UNSIGNED32
Access type	RO
Default value	1'000
Value range	–
PDO mapping	NO
Backup	NO

#### 6.2.34.6 Delay time

The hardware delay time of the slave. The time from receiving the trigger (Sync0 or Sync1 Event) to drive output values to the time until they become valid in the process. The value is given in [ns].

Name	Delay time
Index	0x1C32
Subindex	0x09
Data type	UNSIGNED32
Access type	RO
Default value	1'000
Value range	–
PDO mapping	NO
Backup	NO

#### 6.2.34.7 SM-event missed

The SM-event missed counter.

Name	SM-event missed
Index	0x1C32
Subindex	0x0B
Data type	UNSIGNED16
Access type	RO
Default value	0
Value range	–
PDO mapping	NO
Backup	NO



**6.2.34.8 Cycle time too small**

The cycle time too small/even counter.

Name	Cycle time too small	
Index	0x1C32	
Subindex	0x0C	
Data type	UNSIGNED16	
Access type	RO	
Default value	0	
Value range	–	–
PDO mapping	NO	
Backup	NO	

**6.2.34.9 Sync error**

Displays the sync error information.

Name	Sync error	
Index	0x1C32	
Subindex	0x20	
Data type	BOOL	
Access type	RO	
Default value	0	
Value range	–	–
PDO mapping	YES	
Backup	NO	

Value	Description
1	Synchronization error
0	No synchronization error or Sync error not supported

Table 6-87 Sync values

## 6.2.35 SYNC manager 3 parameter

The object is only available if the active fieldbus is EtherCAT.

Used to display the synchronization of the input parameters.

Name	SYNC manager 3 parameter
Index	0x1C33
Object code	RECORD
Highest subindex supported	32

### 6.2.35.1 Synchronization type

Displays the synchronization type of the input parameters.

Name	Synchronization type
Index	0x1C33
Subindex	0x01
Data type	UNSIGNED16
Access type	RO
Default value	Synchronous with SM2
Value range	→ Table 6-88
PDO mapping	NO
Backup	NO

Value	Description
0x0002	Distributed clock Sync0: Synchronous with SYNC0 event
0x0022	Synchronous with SM2: Synchronous with SM2 event

Table 6-88 SYNC mode input parameters

### 6.2.35.2 Cycle time

Displays the cycle time of the input parameters. In Sync Manager synchronous mode, the value is measured while in Distributed Clock synchronous mode, the value is taken from the Sync0 cycle time register. The value is given in [ns].

Name	Cycle time
Index	0x1C33
Subindex	0x02
Data type	UNSIGNED32
Access type	RO
Default value	–
Value range	–
PDO mapping	NO
Backup	NO

**6.2.35.3 Synchronization types supported**

Displays the supported synchronization modes of the input parameters.

Name	Synchronization types supported	
Index	0x1C33	
Subindex	0x04	
Data type	UNSIGNED16	
Access type	RO	
Default value	–	
Value range	–	–
PDO mapping	NO	
Backup	NO	

Bit	Description
15...7	reserved
6, 5	Shift settings 00 = No output shift supported
4...2	DC mode supported 000 = No DC 001 = DC Sync0
1	Synchronous supported
0	FreeRun supported

Table 6-89 Synchronization types supported – Input parameters

**6.2.35.4 Minimum cycle time**

Displays the minimum cycle time of the input parameters. The value is given in [ns].

Name	Minimum cycle time	
Index	0x1C33	
Subindex	0x05	
Data type	UNSIGNED32	
Access type	RO	
Default value	1'000'000	
Value range	–	–
PDO mapping	NO	
Backup	NO	

#### 6.2.35.5 *Calc and copy time*

The time needed by the application controller to copy the process data from the Sync Manager to the local memory and to perform calculations, if necessary, before the data is sent to the process. The value is given in [ns].

Name	Calc and copy time	
Index	0x1C33	
Subindex	0x06	
Data type	UNSIGNED32	
Access type	RO	
Default value	1'000	
Value range	–	–
PDO mapping	NO	
Backup	NO	

#### 6.2.35.6 *SM-event missed*

The cycle time too small/even counter.

Name	SM-event missed	
Index	0x1C33	
Subindex	0x0B	
Data type	UNSIGNED16	
Access type	RO	
Default value	0	
Value range	–	–
PDO mapping	NO	
Backup	NO	

#### 6.2.35.7 *Cycle time too small*

The cycle time too small/even counter.

Name	Cycle time too small	
Index	0x1C33	
Subindex	0x0C	
Data type	UNSIGNED16	
Access type	RO	
Default value	0	
Value range	–	–
PDO mapping	NO	
Backup	NO	

**6.2.35.8 Sync error**

Displays the sync error information.

Name	Sync error
Index	0x1C33
Subindex	0x20
Data type	BOOL
Access type	RO
Default value	0
Value range	–
PDO mapping	YES
Backup	NO

Value	Description
1	Synchronization error
0	No synchronization error or Sync error not supported

Table 6-90 Sync values

**6.2.36 Program data**

Used to download a firmware file (msdc). Download will commence only if both, a stop program command and a clear program command were immediately received by →Program control.

Related object: →“Program control” on page 6-122

Name	Program data
Index	0x1F50
Object code	ARRAY
Highest subindex supported	1

**6.2.36.1 Program number 1**

Name	Program number 1
Index	0x1F50
Subindex	0x01
Data type	DOMAIN
Access type	WO
Default value	–
Value range	–
PDO mapping	NO
Backup	NO

## 6.2.37 Program control

Initiates firmware download related commands and reads back information on the running application.

While the bootloader is active, only a subset of objects is supported and only one communication interface can be used. For example: The bootloader is activated with the stop program command. If the first command received by the bootloader is sent by USB, the communication is possible via USB only until the application is started with a start program command or a device reset is performed.

To successfully perform a firmware update, the following command sequence must be executed:

Stop program – clear program – download program with write access to → Program data

Related object: → “Program data” on page 6-121

Name	Program control
Index	0x1F51
Object code	ARRAY
Highest subindex supported	1

### 6.2.37.1 Program number 1

Name	Program number 1
Index	0x1F51
Subindex	0x01
Data type	UNSIGNED8
Access type	RW
Default value	–
Value range	→ Table 6-91
PDO mapping	NO
Backup	NO

Value	Write access	Read access
0x00	Stop program: Activate bootloader application	Program stopped: Bootloader application is active
0x01	Start program: Activate Program	Program started: Program is active
0x02	Reset program: Initiate device reset	Not used
0x03	Clear program: Erase the flash memory before new program data is downloaded	No program available: No valid application is available in the flash memory
0x04...0x07	reserved	reserved
0x80	Triggers an ESM state change acknowledge upon application restart. Relevant only for EPOS4 bootloader OBD.	–

Table 6-91 Program control – Value range

## 6.2.38 Program software identification

Provides identification on the loaded program software.

If no valid flash content or program software is available, the program software identification is "0" (zero).

While the bootloader is active, the identification of the actually running bootloader version is returned. After a bootloader update, a device reset or start program command is required for display of the new identification number.

Name	Program software identification
Index	0x1F56
Object code	ARRAY
Highest subindex supported	1

### 6.2.38.1 Program number 1

Name	Program number 1
Index	0x1F56
Subindex	0x01
Data type	UNSIGNED32
Access type	RO
Default value	–
Value range	→Table 6-92
PDO mapping	NO
Backup	NO

Bit	Description
31...16	Identification of the application
15...0	Identification of the bootloader

Table 6-92 Program software identification – Value range

## 6.2.39 *Flash status identification*

Displays the status of the firmware download process.

Name	Flash status identification
Index	0x1F57
Object code	ARRAY
Highest subindex supported	1

### 6.2.39.1 *Program number 1*

Name	Program number 1
Index	0x1F57
Subindex	0x01
Data type	UNSIGNED32
Access type	RO
Default value	–
Value range	→ Table 6-93
PDO mapping	NO
Backup	NO

Continued on next page.



Bit	Value	Description	
31...16		Manufacturer-specific information	
15...8		Reserved, always 0	
7...1	127...93	Reserved for manufacturer-specific errors	
	92	Decryption error [a]	
	91	Authentication sequence error. Expected command sequence (activate bootloader – clear program – write program data) was not observed. [a]	
	90	Flash clear error [a]	
	89	Hardware version mismatch. Received firmware cannot be use with this hardware; manufacturer-specific error. [a]	
	88	Unspecified error [a]	
	87	Flash secured. Write access currently forbidden. [a]	
	86	General address error [a]	
	85	Flash write error [a]	
	84	Flash not cleared before write [a]	
	83	Data format error or data CRC error [a]	
	82	Data format unknown [a]	
	81	No valid program available [a]	
	80...68	Reserved for manufacturer-specific errors [a]	
	67	Decryption error	
	66	Authentication sequence error: Expected command sequence (activate bootloader – clear program – write program data) was not observed.	
	65	Flash clear error	
	64	Hardware version mismatch. Received firmware cannot be use with this hardware; manufacturer-specific error.	
	63	Unspecified error	
	62...8	Reserved	
	7	Flash secured. Write access currently forbidden.	
	6	General address error	
	5	Flash write error	
	4	Flash not cleared before write	
	3	Data format error or data CRC error	
	2	Data format unknown	
	1	No valid program available	
	0	No error occurred, valid program available	
	0	1	Download in progress. Program Software Identification is not valid.
		0	No download in progress. Program Software Identification is valid.
[a] Error received from extension communication module			

Table 6-93 Flash status identification – Value range

## 6.2.40 Node-ID

Defines the node ID of the device and is used by the communication interfaces CAN, USB, and RS232.

If the hardware DIP switches are not set to “0” (zero), the node ID is defined by the DIP switches. The value is read at boot-up and is visible in this object. If the DIP switches are set to “0” (zero), the node ID can be defined by this object. For detailed information on DIP switches see separate document → «Hardware Reference» of respective controller.

Changes to this object only come into effect after restart. Therefore, storing all parameters after a change is required, then restart.

The default value 255 is an invalid node ID and it is expected that the user changes the value to a valid node ID via USB or CAN LSS communication interface. For detailed information on LSS see separate document → «EPOS4 Communication Guide»; chapter “Layer Setting Services (LSS)”.

Related object: → “Active fieldbus” on page 6-130

Name	Node-ID	
Index	0x2000	
Subindex	0x00	
Data type	UNSIGNED8	
Access type	RW	
Default value	255: if the active fieldbus is CANopen 1: if the active fieldbus is EtherCAT	
Value range	1	127 (and 255)
PDO mapping	NO	
Backup	YES	

### 6.2.41 CAN bit rate

**The object is only available if the active fieldbus is CANopen.**

Holds the desired bit rate of the CAN interface.

Changes to this object only come into effect after restart. Therefore, storing all parameters after a change is required, then restart.

Automatic bit rate detection is activated in the following cases:

- CAN bit rate is set to “9” and saved (followed by reset/power on).
- Hardware DIP switch pin “CAN automatic bit rate detection” is activated (during reset/power on).

Name	CAN bit rate
Index	0x2001
Subindex	0x00
Data type	UNSIGNED8
Access type	RW
Default value	0
Value range	→Table 6-94
PDO mapping	NO
Backup	YES

Value	Bit rate
0	1 Mbit/s
1	800 kbit/s
2	500 kbit/s
3	250 kbit/s
4	125 kbit/s
(5)	reserved
6	50 kbit/s
7	20 kbit/s
(8)	not supported (10 kbit/s)
9	Automatic bite rate detection

Table 6-94 CAN bit rate

## 6.2.42 RS232 bit rate

**The object is not available with...**

- «EPOS4 Disk 60/8 EtherCAT»
- «EPOS4 Disk 60/12 EtherCAT»
- «EPOS4 Micro 24/5 EtherCAT»

Sets the bit rate of the serial communication interface.

Changes to this object only come into effect after restart. Therefore, storing all parameters after a change is required, then restart.

Name	RS232 bit rate
Index	0x2002
Subindex	0x00
Data type	UNSIGNED8
Access type	RW
Default value	5
Value range	→Table 6-95
PDO mapping	NO
Backup	YES

Value	Bit rate
0	9.6 kbit/s
1	14.4 kbit/s
2	19.2 kbit/s
3	38.4 kbit/s
4	57.6 kbit/s
5	115.2 kbit/s

Table 6-95 RS232 bit rate

### 6.2.43 RS232 frame timeout

**The object is not available with...**

- «EPOS4 Disk 60/8 EtherCAT»
- «EPOS4 Disk 60/12 EtherCAT»
- «EPOS4 Micro 24/5 EtherCAT»

Defines the timeout over a RS232 communication frame. It is scaled in [ms].

Name	RS232 frame timeout	
Index	0x2005	
Subindex	0x00	
Data type	UNSIGNED16	
Access type	RW	
Default value	500	
Value range	50	65'535
PDO mapping	NO	
Backup	YES	

### 6.2.44 USB frame timeout

Defines the timeout over a USB communication frame. It is scaled in [ms].

Name	USB frame timeout	
Index	0x2006	
Subindex	0x00	
Data type	UNSIGNED16	
Access type	RW	
Default value	500	
Value range	50	65'535
PDO mapping	NO	
Backup	YES	

### 6.2.45 CAN bit rate display

The object is only available if the active fieldbus is CANopen.

Represents the actually configured CAN bit rate. Its value can differ from the value of the object →“CAN bit rate” on page 6-127 if automatic bit rate detection is or was active. In all other cases, the value of these two objects are identical.

Related object: →“CAN bit rate” on page 6-127

Name	CAN bit rate display
Index	0x200A
Subindex	0x00
Data type	UNSIGNED8
Access type	RO
Default value	–
Value range	→Table 6-94
PDO mapping	NO
Backup	NO

### 6.2.46 Active fieldbus

Shows the actual active fieldbus.

Name	Active fieldbus
Index	0x2010
Subindex	0x00
Data type	UNSIGNED8
Access type	RO
Default value	–
Value range	→Table 6-96
PDO mapping	NO
Backup	NO

Value	Fieldbus
0	None
1	CANopen
2	EtherCAT

Table 6-96 Fieldbus type

## 6.2.47 *Additional identity*

Name	Additional identity
Index	0x2100
Object code	RECORD
Highest subindex supported	1

### 6.2.47.1 *Serial number complete*

Contains the full 64-bit device serial number.

Name	Serial number complete
Index	0x2100
Subindex	0x01
Data type	UNSIGNED64
Access type	RO
Default value	–
Value range	–
PDO mapping	NO
Backup	YES

## 6.2.48 *Extension 1 identity*

**The object is only available if the active fieldbus is EtherCAT.**

Shows version information of the connected extension communication.

Name	Extension 1 identity
Index	0x2101
Object code	RECORD
Highest subindex supported	6

### 6.2.48.1 *Extension 1 software version*

Contains the software version of the connected extension communication.

Name	Extension 1 software version
Index	0x2101
Subindex	0x01
Data type	UNSIGNED16
Access type	RO
Default value	–
Value range	–
PDO mapping	NO
Backup	NO

### 6.2.48.2 *Extension 1 hardware version*

Contains the software version of the connected extension communication.

Name	Extension 1 hardware version
Index	0x2101
Subindex	0x02
Data type	UNSIGNED16
Access type	RO
Default value	–
Value range	→ Table 6-97
PDO mapping	NO
Backup	NO

Hardware version	Hardware
0x5100	EtherCAT extension

Table 6-97 Extension 1 hardware – Version definition

### 6.2.48.3 *Extension 1 application number*

Contains the application number of the connected extension communication.

Name	Extension 1 application number
Index	0x2101
Subindex	0x03
Data type	UNSIGNED16
Access type	RO
Default value	–
Value range	–
PDO mapping	NO
Backup	NO

### 6.2.48.4 *Extension 1 application version*

Contains the application number of the connected extension communication.

Name	Extension 1 application version
Index	0x2101
Subindex	0x04
Data type	UNSIGNED16
Access type	RO
Default value	–
Value range	–
PDO mapping	NO
Backup	NO



**6.2.48.5** *Extension 1 serial number*

Contains the full 64-bit device serial number of the connected extension communication.

Name	Extension 1 serial number	
Index	0x2101	
Subindex	0x05	
Data type	UNSIGNED64	
Access type	RO	
Default value	–	
Value range	–	–
PDO mapping	NO	
Backup	NO	

**6.2.48.6** *Extension 1 type*

Contains the type of the connected extension communication.

Name	Extension 1 type	
Index	0x2101	
Subindex	0x06	
Data type	UNSIGNED8	
Access type	RO	
Default value	–	
Value range	→ Table 6-98	
PDO mapping	NO	
Backup	NO	

Value	Fieldbus
0	None
2	EtherCAT

Table 6-98 Extension communication type

## 6.2.49 Custom persistent memory

Name	Custom persistent memory
Index	0x210C
Object code	ARRAY
Highest subindex supported	4

### 6.2.49.1 Custom persistent memory (1...4)

Can be used to store custom values (for example axis numbers, identifications, etc.) on the EPOS4. The stored values will not be evaluated by the firmware but will be cleared by setting the default parameters.

Names	Custom persistent memory 1 Custom persistent memory 2 Custom persistent memory 3 Custom persistent memory 4
Index	0x210C
Subindex	0x01...0x04
Data type	UNSIGNED32
Access type	RW
Default value	0
Value range	–
PDO mapping	NO
Backup	YES

## 6.2.50 Power supply

Used to display the power supply parameters.

Name	Power supply
Index	0x2200
Object code	RECORD
Highest subindex supported	1

### 6.2.50.1 Power supply voltage

Represents the actual power supply voltage. The value is given in [0.1 V].

Name	Power supply voltage
Index	0x2200
Subindex	0x01
Data type	UNSIGNED16
Access type	RO
Default value	–
Value range	–
PDO mapping	NO
Backup	NO

## 6.2.51 Power supply supervision

Used to customize power supervision.

Name	Power supply supervision
Index	0x2201
Object code	RECORD
Highest subindex supported	2

### 6.2.51.1 Power supply undervoltage limit

If the supply voltage falls below this undervoltage limit, the →Undervoltage error will be set. The device can only be enabled if the supply voltage is higher than the summed undervoltage limit (→Table 6-99) plus the hysteresis undervoltage (→Table 6-100). The value is given in [0.001 V].

The maximum value is →Power supply overvoltage limit (0x2201; 0x02) “Max” value minus the sum of the voltage hysteresis (→Table 6-100). If the undervoltage limit is set higher than the overvoltage limit, the overvoltage limit will be adjusted accordingly.

Name	Power supply undervoltage limit
Index	0x2201
Subindex	0x01
Data type	UNSIGNED32
Access type	RW
Default value	→Table 6-99
Value range	→Table 6-99
PDO mapping	NO
Backup	NO

Hardware	Default	Min	Max
EPOS4 Disk 60/8 CAN EPOS4 Disk 60/8 EtherCAT	8'000	8'000	62'500
EPOS4 Disk 60/12 CAN EPOS4 Disk 60/12 CAN SSC EPOS4 Disk 60/12 EtherCAT EPOS4 Disk 60/12 EtherCAT SSC	8'000	8'000	62'500
EPOS4 Micro 24/5 CAN	7'000	7'000	28'500
EPOS4 Micro 24/5 EtherCAT EPOS4 Compact 24/5 EtherCAT 3-axes	7'000	7'000	28'500
EPOS4 Module 24/1.5 EPOS4 Compact 24/1.5 CAN EPOS4 Compact 24/1.5 EtherCAT	8'000	8'000	28'500
EPOS4 Module 50/5 EPOS4 Compact 50/5 CAN EPOS4 Compact 50/5 EtherCAT	8'000	8'000	55'500
EPOS4 Module 50/8 EPOS4 Compact 50/8 CAN EPOS4 Compact 50/8 EtherCAT	8'000	8'000	55'500
EPOS4 Module 50/15 EPOS4 Compact 50/15 CAN EPOS4 Compact 50/15 EtherCAT	8'000	8'000	55'500

Continued on next page.

Hardware	Default	Min	Max
EPOS4 50/5	8'000	8'000	55'500
EPOS4 70/15	8'000	8'000	74'500

Table 6-99 Power supply voltage – Undervoltage limit

Hardware	Hysteresis undervoltage	Hysteresis overvoltage
EPOS4 Disk 60/8 CAN EPOS4 Disk 60/8 EtherCAT	500	1'000
EPOS4 Disk 60/12 CAN EPOS4 Disk 60/12 CAN SSC EPOS4 Disk 60/12 EtherCAT EPOS4 Disk 60/12 EtherCAT SSC	500	1'000
EPOS4 Micro 24/5 CAN	500	3'000
EPOS4 Micro 24/5 EtherCAT EPOS4 Compact 24/5 EtherCAT 3-axes	500	3'000
EPOS4 Module 24/1.5 EPOS4 Compact 24/1.5 CAN EPOS4 Compact 24/1.5 EtherCAT	500	3'000
EPOS4 Module 50/5 EPOS4 Compact 50/5 CAN EPOS4 Compact 50/5 EtherCAT	500	2'000
EPOS4 Module 50/8 EPOS4 Compact 50/8 CAN EPOS4 Compact 50/8 EtherCAT	500	2'000
EPOS4 Module 50/15 EPOS4 Compact 50/15 CAN EPOS4 Compact 50/15 EtherCAT	500	2'000
EPOS4 50/5	500	2'000
EPOS4 70/15	500	3'000

Table 6-100 Power supply voltage – Hysteresis

## 6.2.51.2 Power supply overvoltage limit

If the supply voltage raises above this overvoltage limit, the →Overvoltage error will be set. The error can only be cleared if the supply voltage falls below the overvoltage limit minus hysteresis overvoltage (→Table 6-101). The value is given in [0.001 V].

The overvoltage limit's "Min" value is dependent on the →Power supply undervoltage limit (0x2201; 0x01) and must be equal or larger than the summed undervoltage limit (→Table 6-99) plus the hysteresis undervoltage plus the hysteresis overvoltage (→Table 6-100).

Name	Power supply overvoltage limit
Index	0x2201
Subindex	0x02
Data type	UNSIGNED32
Access type	RW
Default value	→Table 6-101
Value range	→Table 6-101
PDO mapping	NO
Backup	NO

Hardware	Default	Min	Max
EPOS4 Disk 60/8 CAN EPOS4 Disk 60/8 EtherCAT	64'000	Dependent on the undervoltage limit (→Table 6-99)	64'000
EPOS4 Disk 60/12 CAN EPOS4 Disk 60/12 CAN SSC EPOS4 Disk 60/12 EtherCAT EPOS4 Disk 60/12 EtherCAT SSC	64'000		64'000
EPOS4 Micro 24/5 CAN	32'000		32'000
EPOS4 Micro 24/5 EtherCAT EPOS4 Compact 24/5 EtherCAT 3-axes	32'000		32'000
EPOS4 Module 24/1.5 EPOS4 Compact 24/1.5 CAN EPOS4 Compact 24/1.5 EtherCAT	32'000		32'000
EPOS4 Module 50/5 EPOS4 Compact 50/5 CAN EPOS4 Compact 50/5 EtherCAT	58'000		58'000
EPOS4 Module 50/8 EPOS4 Compact 50/8 CAN EPOS4 Compact 50/8 EtherCAT	58'000		58'000
EPOS4 Module 50/15 EPOS4 Compact 50/15 CAN EPOS4 Compact 50/15 EtherCAT	58'000		58'000
EPOS4 50/5	58'000		58'000
EPOS4 70/15	78'000		78'000

Table 6-101 Power supply voltage – Overvoltage limit

## 6.2.52 Axis configuration

Used to setup the main components of the axis by configuring the sensors and the control structure.

Write access is only permitted in device state «Power Disable».

Related object: →“Motor type” on page 6-263

Name	Axis configuration
Index	0x3000
Object code	RECORD
Highest subindex supported	6

### 6.2.52.1 Sensors configuration

Used to define the sensor types used for the axis.

- If →“Motor type” on page 6-263 is set to “brushed DC motor”, the field “Digital Hall sensor” is set to “none”.
- Upon changing this parameter, the absolute position may be corrupted. Therefore, «Position referenced to home position» (→“Statusword” on page 6-222), →“Position actual value” on page 6-227, and →“Additional position actual values” on page 6-256 will be cleared.

Related objects: →“Digital incremental encoder 1” on page 6-156 / →“Digital incremental encoder 2” on page 6-170 / →“Digital Hall sensor” on page 6-168 / →“SSI absolute encoder” on page 6-160 / →“Analog incremental encoder” on page 6-158

Name	Sensors configuration
Index	0x3000
Subindex	0x01
Data type	UNSIGNED32
Access type	RW
Default value	0x00100001
Value range	→Table 6-102 and Table 6-103
PDO mapping	NO
Backup	YES

Bit 31...24	Bit 23...16	Bit 15...8	Bit 7...0
reserved (0)	Sensor 3 type	Sensor 2 type	Sensor 1 type

Table 6-102 Sensor configuration – Bits

Continued on next page.

Name	Value	Description
Sensor 1 type	0x00	None
	0x01	Digital incremental encoder 1
Sensor 2 type	0x00	None
	0x01	Digital incremental encoder 2 [a]
	0x02	Analog incremental encoder SinCos [a]
	0x03	SSI absolute encoder
Sensor 3 type	0x00	None
	0x10	Digital Hall Sensor (EC motors only)
[a] Not available with «EPOS4 Disk 60/8» / «EPOS4 Disk 60/12» / «EPOS4 Micro 24/5»		

Table 6-103 Supported sensor types

**Find details here:**

For detailed information on socket and pin assignment see separate document →«Hardware Reference» of respective controller.

**6.2.52.2 Control structure**

Defines the control structure of the axis depended on the available sensors.

- The main sensor and the auxiliary sensor can only be selected if the corresponding value of →Sensors configuration (0x3000; 0x01) has been configured (not “none”).
- The auxiliary sensor can only be selected if the main sensor has been configured (not “none”).
- The auxiliary sensor must be mounted on the motor shaft.
- Using one single physical sensor for the purpose of both main sensor and auxiliary sensor is not permitted.
- Setting the mounting position of a sensor on a gear is only permitted if a gear has been configured (not “none”).
- The mounting positions of the auxiliary sensor and the main sensor cannot be the same. If this behavior is required, the gear ratio must be set to 1:1 (virtual gear).
- The mounting position for commutation sensors must be “on motor”.
- Dual loop position controller can only be selected if both main sensor and auxiliary sensor have been configured (not “none”). Single loop controller is supported with main sensor only.
- The process value reference must be of the same value as the mounting position of the sensor that is configured as main sensor. If sensor 1 is mounted “on gear” and configured as main sensor, the process value reference must be “on gear” as well.
- Take into account that the position control quality depends, among other influences, on the resolution of the main sensor. For some sensor types, such as SSI, the “position refresh rate” has an additional influence on the position control quality. Increase the sensor’s “data rate” to improve position control quality.

Continued on next page.

- Upon changing this parameter, the absolute position may be corrupted. Therefore, →«Position referenced to home position» (→“Statusword” on page 6-222), →“Position actual value” on page 6-227, and →“Additional position actual values” on page 6-256 will be cleared.

Name	Control structure
Index	0x3000
Subindex	0x02
Data type	UNSIGNED32
Access type	RW
Default value	0x00010111
Value range	→Table 6-104, Table 6-105, and Table 6-106
PDO mapping	NO
Backup	YES





Bit	Name	Value	Description
31...30	reserved	0	–
29...28	Mounting Position Sensor 3	0	On motor
27...26	Mounting Position Sensor 2	0	On motor (or undefined)
		1	On gear
25...24	Mounting Position Sensor 1	0	On motor (or undefined)
		1	On gear
23...20	Auxiliary Sensor	0	None
		1	Sensor 1
		2	Sensor 2
		3	Sensor 3
19...16	Main Sensor	0	None
		1	Sensor 1
		2	Sensor 2
		3	Sensor 3
15...14	Process Value Reference	0	On motor (or undefined)
		1	On gear
13	reserved	0	–
12	Gear	0	None
		1	Gear mounted to the system
11...8	Position Control Structure	0	None
		1	PID position controller
		2	Dual loop position controller
7...4	Velocity Control Structure	0	None
		1	PI velocity controller (low pass filter)
		2	PI velocity controller (observer)
3...0	Current Control Structure	1	PI current controller

Table 6-104 Control structure – Bits

Continued on next page.



**CONFIGURATION WITHOUT GEAR**

Value (hex)	Description	Motor		
		DC	EC block	EC sinus
0 x 0 0 0 0 0 0 0 1 *1) *3)	 <ul style="list-style-type: none"> <li>PI current controller</li> <li><b>No</b> PI velocity controller</li> <li><b>No</b> PID position controller</li> <li>Process value reference on motor (or undefined)</li> <li><b>No</b> main sensor</li> <li>Mounting position on motor (or undefined)</li> </ul>	✓	✓	✓
0 x 0 0 0 1 0 1 V 1	 <ul style="list-style-type: none"> <li>PI current controller</li> <li>PI velocity controller with [1: low pass filter, 2: observer]</li> <li>PID position controller</li> <li>Process value reference on motor (or undefined)</li> <li>Sensor 1 is main sensor</li> <li>Mounting position on motor (or undefined)</li> </ul>	✓	✓	✓
0 x 0 0 0 2 0 1 V 1	 <ul style="list-style-type: none"> <li>PI current controller</li> <li>PI velocity controller with [1: low pass filter, 2: observer]</li> <li>PID position controller</li> <li>Process value reference on motor (or undefined)</li> <li>Sensor 2 is main sensor</li> <li>Mounting position on motor (or undefined)</li> </ul>	✓	✓	✓
0 x 0 0 0 3 0 1 V 1 *2)	 <ul style="list-style-type: none"> <li>PI current controller</li> <li>PI velocity controller with [1: low pass filter, 2: observer]</li> <li>PID position controller</li> <li>Process value reference on motor (or undefined)</li> <li>Sensor 3 is main sensor</li> <li>Mounting position on motor (or undefined)</li> </ul>	—	✓	✓

(\*1) Configuration does not support max speed limitation

(\*2) Configuration reduces control quality due to poor sensor resolution

(\*3) Configuration supports CST mode only

Table 6-105 Control structure without gear – permitted values

Continued on next page.

**CONFIGURATION WITH GEAR**

Value (hex)	Description	Motor		
		DC	EC block	EC sinus
0 x 0 M 0 0 1 0 0 1	<p><b>*1) *3) *4)</b></p> <ul style="list-style-type: none"> <li>PI current controller</li> <li><b>No</b> PI velocity controller</li> <li><b>No</b> PID position controller</li> <li>Gear configured   process value reference on motor (or undefined)</li> <li><b>No</b> main sensor</li> <li>Mounting position sensor 1 on motor   sensor 2 [0: on motor, 4: on gear]</li> <li>Mounting position sensor 3 on motor (or undefined)</li> </ul>	✓	✓	✓
0 x 0 M 0 0 1 0 0 1	<p><b>*1) *3) *4)</b></p> <ul style="list-style-type: none"> <li>PI current controller</li> <li><b>No</b> PI velocity controller</li> <li><b>No</b> PID position controller</li> <li>Gear configured   process value reference on motor (or undefined)</li> <li><b>No</b> main sensor</li> <li>Mounting position sensor 1 on gear   sensor 2 [1: on motor, 5: on gear]</li> <li>Mounting position sensor 3 on motor (or undefined)</li> </ul>	✓	✓	✓
0 x 0 M 0 1 1 1 V 1	<ul style="list-style-type: none"> <li>PI current controller</li> <li>PI velocity controller with [1: low pass filter, 2: observer]</li> <li>PID position controller</li> <li>Gear configured   process value reference on motor (or undefined)</li> <li>Sensor 1 is main sensor</li> <li>Mounting position sensor 1 on motor   sensor 2 [0: on motor, 4: on gear]</li> <li>Mounting position sensor 3 on motor (or undefined)</li> </ul>	✓	✓	✓
0 x 0 M 0 2 1 1 V 1	<ul style="list-style-type: none"> <li>PI current controller</li> <li>PI velocity controller with [1: low pass filter, 2: observer]</li> <li>PID position controller</li> <li>Gear configured   process value reference on motor (or undefined)</li> <li>Sensor 2 is main sensor</li> <li>Mounting position sensor 1 [0: on motor, 1: on gear]   sensor 2 on motor</li> <li>Mounting position sensor 3 on motor (or undefined)</li> </ul>	✓	✓	✓

Continued on next page.

Value (hex)	Description	Motor		
		DC	EC block	EC sinus
0 x 0 1 0 1 5 1 V 1	<ul style="list-style-type: none"> <li>PI current controller</li> <li>PI velocity controller with [1: low pass filter, 2: observer]</li> <li>PID position controller</li> <li>Gear configured   process value reference on gear</li> <li>Sensor 1 is main sensor</li> <li>Mounting position sensor 1 on gear   sensor 2 on motor</li> <li>Mounting position sensor 3 on motor (or undefined)</li> </ul>	✓	✓	✓
0 x 0 5 0 1 5 1 V 1	<ul style="list-style-type: none"> <li>PI current controller</li> <li>PI velocity controller with [1: low pass filter, 2: observer]</li> <li>PID position controller</li> <li>Gear configured   process value reference on gear</li> <li>Sensor 1 is main sensor</li> <li>Mounting position sensor 1 on gear   sensor 2 on gear</li> <li>Mounting position sensor 3 on motor (or undefined)</li> </ul>	✓	✓	—
0 x 0 4 0 2 5 1 V 1	<ul style="list-style-type: none"> <li>PI current controller</li> <li>PI velocity controller with [1: low pass filter, 2: observer]</li> <li>PID position controller</li> <li>Gear configured   process value reference on gear</li> <li>Sensor 2 is main sensor</li> <li>Mounting position sensor 1 on motor   sensor 2 on gear</li> <li>Mounting position sensor 3 on motor (or undefined)</li> </ul>	✓	✓	✓
0 x 0 5 0 2 5 1 V 1	<ul style="list-style-type: none"> <li>PI current controller</li> <li>PI velocity controller with [1: low pass filter, 2: observer]</li> <li>PID position controller</li> <li>Gear configured   process value reference on gear</li> <li>Sensor 2 is main sensor</li> <li>Mounting position sensor 1 on gear   sensor 2 on gear</li> <li>Mounting position sensor 3 on motor (or undefined)</li> </ul>	✓	✓	—
0 x 0 M 0 3 1 1 V 1 *2)	<ul style="list-style-type: none"> <li>PI current controller</li> <li>PI velocity controller with [1: low pass filter, 2: observer]</li> <li>PID position controller</li> <li>Gear configured   process value reference on motor (or undefined)</li> <li>Sensor 3 is main sensor</li> <li>Mounting position sensor 1 on motor   sensor 2 [0: on motor, 4: on gear]</li> <li>Mounting position sensor 3 on motor (or undefined)</li> </ul>	—	✓	✓

Continued on next page.





Value (hex)	Description	Motor		
		DC	EC block	EC sinus
0 x 0 1 0 3 1 1 V 1 *2)	<ul style="list-style-type: none"> <li>PI current controller</li> <li>PI velocity controller with [1: low pass filter, 2: observer]</li> <li>PID position controller</li> <li>Gear configured   process value reference on motor (or undefined)</li> <li>Sensor 3 is main sensor</li> <li>Mounting position sensor 1 on gear   sensor 2 on motor</li> <li>Mounting position sensor 3 on motor (or undefined)</li> </ul>	—	✓	✓
0 x 0 5 0 3 1 1 V 1 *2)	<ul style="list-style-type: none"> <li>PI current controller</li> <li>PI velocity controller with [1: low pass filter, 2: observer]</li> <li>PID position controller</li> <li>Gear configured   process value reference on motor (or undefined)</li> <li>Sensor 3 is main sensor</li> <li>Mounting position sensor 1 on gear   sensor 2 on gear</li> <li>Mounting position sensor 3 on motor (or undefined)</li> </ul>	—	✓	—

- (\*1) Configuration does not support max speed limitation
- (\*2) Configuration reduces control quality due to poor sensor resolution
- (\*3) Configuration supports CST mode only
- (\*4) Gear configuration has no effect on system behavior

Table 6-106 Control structure with gear – permitted values

Continued on next page.

CONFIGURATION WITH GEAR AND DUAL LOOP CONTROL

Value (hex)	Description	Motor		
		DC	EC block	EC sinus
0 x 0 1 2 1 5 2 V 1	 <ul style="list-style-type: none"> <li>PI current controller</li> <li>PI velocity controller with [1: low pass filter, 2: observer]</li> <li>Dual loop position control</li> <li>Gear configured   process value reference on gear</li> <li>Sensor 1 is main sensor</li> <li>Sensor 2 is auxiliary sensor</li> <li>Mounting position sensor 1 on gear   sensor 2 on motor</li> <li>Mounting position sensor 3 on motor (or undefined)</li> </ul>	✓	✓	✓
0 x 0 1 3 1 5 2 V 1 *2) *5)	 <ul style="list-style-type: none"> <li>PI current controller</li> <li>PI velocity controller with [1: low pass filter, 2: observer]</li> <li>Dual loop position control</li> <li>Gear configured   process value reference on gear</li> <li>Sensor 1 is main sensor</li> <li>Sensor 3 is auxiliary sensor</li> <li>Mounting position sensor 1 on gear   sensor 2 on motor (or undefined)</li> <li>Mounting position sensor 3 on motor (or undefined)</li> </ul>	—	✓	✓
0 x 0 5 3 1 5 2 V 1 *2)	 <ul style="list-style-type: none"> <li>PI current controller</li> <li>PI velocity controller with [1: low pass filter, 2: observer]</li> <li>Dual loop position control</li> <li>Gear configured   process value reference on gear</li> <li>Sensor 1 is main sensor</li> <li>Sensor 3 is auxiliary sensor</li> <li>Mounting position sensor 1 on gear   sensor 2 on gear</li> <li>Mounting position sensor 3 on motor (or undefined)</li> </ul>	—	✓	—
0 x 0 4 1 2 5 2 V 1	 <ul style="list-style-type: none"> <li>PI current controller</li> <li>PI velocity controller with [1: low pass filter, 2: observer]</li> <li>Dual loop position control</li> <li>Gear configured   process value reference on gear</li> <li>Sensor 2 is main sensor</li> <li>Sensor 1 is auxiliary sensor</li> <li>Mounting position sensor 2 on gear   sensor 1 on motor</li> <li>Mounting position sensor 3 on motor (or undefined)</li> </ul>	✓	✓	✓

Continued on next page.

Value (hex)	Description	Motor		
		DC	EC block	EC sinus
0 x 0 4 3 2 5 2 V 1 *2) *5) 	*2) *5) PI current controller PI velocity controller with [1: low pass filter, 2: observer] Dual loop position control Gear configured   process value reference on gear Sensor 2 is main sensor Sensor 3 is auxiliary sensor Mounting position sensor 2 on gear   sensor 1 on motor (or undefined) Mounting position sensor 3 on motor (or undefined)	—	✓	✓
0 x 0 5 3 2 5 2 V 1 *2) 	*2) PI current controller PI velocity controller with [1: low pass filter, 2: observer] Dual loop position control Gear configured   process value reference on gear Sensor 2 is main sensor Sensor 3 is auxiliary sensor Mounting position sensor 1 on gear   sensor 2 on gear Mounting position sensor 3 on motor (or undefined)	—	✓	—

(\*2) Configuration reduces control quality due to poor sensor resolution

(\*5) Depending on mounting position of auxiliary sensor, sinusoidal commutation may not be possible

Table 6-107 Control structure with gear and dual loop control – permitted values

### 6.2.52.3 Commutation sensors

Defines the control structure of the axis dependent on the available sensors and their disposition.

Defines the commutation sensors for the axis motor. For “brushed DC motor” without meaning. For “brushless DC motor”, the entry may not be set to 0x0000 (no commutation sensor defined). “Sensor absolute” is used for sensors that do not require additional alignment to perform commutation (for example digital Hall sensors). In contrast, “Sensor relative” is used if additional algorithms are required to use the sensor as commutation sensor (for example digital incremental encoder). Combinations of both relative and absolute commutation sensor are possible.

- The commutation sensor absolute, as well as the commutation sensor relative can only be selected if the corresponding value of «Sensor configuration» is configured (not none).
- If a sensor is used as commutation sensor, it must be mounted on the motor shaft. The configuration is done by →“Control structure” on page 6-139.
- For some sensor types, such as SSI, the position refresh rate has an influence on the commutation quality. Increase the sensor’s “data rate” to improve commutation quality or do not use relating sensor for commutation.

Name	Commutation sensors
Index	0x3000
Subindex	0x03
Data type	UNSIGNED32
Access type	RW
Default value	0x00000031
Value range	→Table 6-108 and Table 6-109
PDO mapping	NO
Backup	YES

Bit	Name	Value	Description
31...8	reserved	0	–
7...4	Commutation Sensor Absolute	0	None
		2	Sensor 2
		3	Sensor 3
3...0	Commutation Sensor Relative	0	None
		1	Sensor 1
		2	Sensor 2
		3	Sensor 3

Table 6-108 Commutation sensors – Bits

Value	Description	Motor type supported
0x00000000	No commutation sensor defined	DC motor
0x00000020	Sensor 2 used for commutation [a]	EC sinus (SSI encoder only)
0x00000030	Sensor 3 used for commutation [a]	EC block
0x00000031	Sensor 3 and Sensor 1 used for commutation [a]	EC sinus
0x00000032	Sensor 3 and Sensor 2 used for commutation [a]	EC sinus
[a] The value can only be set if a supported motor type is selected (→“Motor type” on page 6-263)		

Table 6-109 Commutation sensors – Value range

### 6.2.52.4 Axis configuration miscellaneous

Used to define various options regarding the axis configuration.

Name	Axis configuration miscellaneous
Index	0x3000
Subindex	0x04
Data type	UNSIGNED32
Access type	RW
Default value	0x00000000
Value range	→ Table 6-110
PDO mapping	NO
Backup	YES

Bit	Name	Value	Description
31...10	reserved	0	–
9	Commutation (auxiliary) sensor supervision [a]	1	Commutation (auxiliary) sensor supervision disabled
		0	Commutation (auxiliary) sensor supervision enabled
8	Sensor supervision	1	Main sensor supervision disabled
		0	Main sensor supervision enabled
7...1	reserved	0	–
0	Axis polarity	1	Inverse polarity – rotational direction of the axis is CW when positive demanded values are attached
		0	Normal polarity – rotational direction of the axis is CCW when positive demanded values are attached

[a] With an unsupervised commutation sensor, commutation errors cannot be detected and the motor might possibly behave incorrect.

Table 6-110 Axis configuration miscellaneous – Bits

### 6.2.52.5 Main sensor resolution

Displays the resolution of the main sensor given in [increments/revolution].

Name	Main sensor resolution
Index	0x3000
Subindex	0x05
Data type	UNSIGNED32
Access type	RO
Default value	–
Value range	–
PDO mapping	NO
Backup	NO



## 6.2.52.6 Max system speed

Displays the max system speed. The value is given in [velocity units] (→page 2-19).

Related objects: →“Motor type” on page 6-263 / →“Max profile velocity” on page 6-235 / →“Max motor speed” on page 6-235 / →“Target velocity” on page 6-263 / →“Max gear input speed” on page 6-155

Name	Max system speed	
Index	0x3000	
Subindex	0x06	
Data type	UNSIGNED32	
Access type	RO	
Default value	–	
Value range	1	→ Table 6-111 → Table 6-112
PDO mapping	NO	
Backup	NO	

Velocity limit		Max motor speed greater Max gear input speed	Max motor speed lower or equal Max gear input speed
Gear	no	Max motor speed	Max motor speed
	yes	$\frac{\text{Max gear input speed}}{\text{Absolute gear reduction}}$	$\frac{\text{Max motor speed}}{\text{Absolute gear reduction}}$

Table 6-111 Max system speed – Limits

Velocity units factor	Max system speed limited by velocity units	Limit
$10^0 / 10^{-1} / 10^{-2} / 10^{-3} / 10^{-4}$	No	—
$10^{-5}$	Yes	21474.83647
$10^{-6}$	Yes	2147.483647

Table 6-112 Max system speed – Speed limitations based on velocity units

## 6.2.53 Motor data

Used to configure the parameters of the motor.

Some parameters are used to limit the output current according to the I2t method. For detailed motor specifications → maxon catalog.

Related object: → “Motor type” on page 6-263

Name	Motor data
Index	0x3001
Object code	RECORD
Highest subindex supported	5

### 6.2.53.1 Nominal current

Represents the nominal current of the motor [mA]. Continuous operation of the motor at this current level and at 25 °C ambient will cause the winding to ultimately reach the specified maximal winding temperature. This assumes no heat sinking. The value can be substantially increased if the motor mount is made of heat-dissipating materials.

Related object: → “Motor rated torque” on page 6-231

Name	Nominal current
Index	0x3001
Subindex	0x01
Data type	UNSIGNED32
Access type	RW
Default value	→ Table 6-113
Value range	→ Table 6-113
PDO mapping	RXPDO
Backup	YES

Hardware	Default	Min	Max
EPOS4 Disk 60/8 CAN EPOS4 Disk 60/8 EtherCAT	8'000	0	8'000
EPOS4 Disk 60/12 CAN EPOS4 Disk 60/12 CAN SSC EPOS4 Disk 60/12 EtherCAT EPOS4 Disk 60/12 EtherCAT SSC	12'000	0	12'000
EPOS4 Micro 24/5 CAN	5'000	0	5'000
EPOS4 Micro 24/5 EtherCAT EPOS4 Compact 24/5 EtherCAT 3-axes	5'000	0	5'000
EPOS4 Module 24/1.5 EPOS4 Compact 24/1.5 CAN EPOS4 Compact 24/1.5 EtherCAT	1'500	0	1'500
EPOS4 Module 50/5 EPOS4 Compact 50/5 CAN EPOS4 Compact 50/5 EtherCAT	5'000	0	5'000
EPOS4 Module 50/8 EPOS4 Compact 50/8 CAN EPOS4 Compact 50/8 EtherCAT	8'000	0	8'000

Continued on next page.

Hardware	Default	Min	Max
EPOS4 Module 50/15 EPOS4 Compact 50/15 CAN EPOS4 Compact 50/15 EtherCAT	15'000	0	15'000
EPOS4 50/5	5'000	0	5'000
EPOS4 70/15	15'000	0	15'000

Table 6-113 Nominal current

### 6.2.53.2 Output current limit

Represents the maximal permissible current of the motor [mA]. We recommend to set the value to double of →Nominal current.

Related object: →“Thermal time constant winding” on page 6-152

Name	Output current limit
Index	0x3001
Subindex	0x02
Data type	UNSIGNED32
Access type	RW
Default value	→Table 6-114
Value range	→Table 6-114
PDO mapping	RXPDO
Backup	YES

Hardware	Default	Min	Max
EPOS4 Disk 60/8 CAN EPOS4 Disk 60/8 EtherCAT	24'000	0	24'000
EPOS4 Disk 60/12 CAN EPOS4 Disk 60/12 CAN SSC EPOS4 Disk 60/12 EtherCAT EPOS4 Disk 60/12 EtherCAT SSC	36'000	0	36'000
EPOS4 Micro 24/5 CAN	15'000	0	15'000
EPOS4 Micro 24/5 EtherCAT EPOS4 Compact 24/5 EtherCAT 3-axes	15'000	0	15'000
EPOS4 Module 24/1.5 EPOS4 Compact 24/1.5 CAN EPOS4 Compact 24/1.5 EtherCAT	4'500	0	4'500
EPOS4 Module 50/5 EPOS4 Compact 50/5 CAN EPOS4 Compact 50/5 EtherCAT	15'000	0	15'000
EPOS4 Module 50/8 EPOS4 Compact 50/8 CAN EPOS4 Compact 50/8 EtherCAT	30'000	0	30'000
EPOS4 Module 50/15 EPOS4 Compact 50/15 CAN EPOS4 Compact 50/15 EtherCAT	30'000	0	30'000
EPOS4 50/5	15'000	0	15'000
EPOS4 70/15	30'000	0	30'000

Table 6-114 Output current limit

**6.2.53.3** *Number of pole pairs*

Represents the number of magnetic pole pairs (number of poles divided by 2) of the rotor of a brushless DC motor (maxon EC motor/BLDC motor).

Write access is only permitted in device state «Power Disable».

Related object: →“Max motor speed” on page 6-235

Name	Number of pole pairs	
Index	0x3001	
Subindex	0x03	
Data type	UNSIGNED8	
Access type	RW	
Default value	1	
Value range	1	255
PDO mapping	NO	
Backup	YES	

**6.2.53.4** *Thermal time constant winding*

Represents the thermal time constant of motor winding. It is used to calculate the length of time the →“Output current limit” on page 6-151 (subindex 0x02) is permitted to be connected to the motor. The value is given in [0.1 s]. Example: For a time constant of 4 seconds, set the value “40”.

Name	Thermal time constant winding	
Index	0x3001	
Subindex	0x04	
Data type	UNSIGNED16	
Access type	RW	
Default value	40	
Value range	1	10'000
PDO mapping	NO	
Backup	YES	

**6.2.53.5** *Torque constant*

Represents the motor's torque constant. The value is given in [ $\mu\text{Nm/A}$ ].

Related object: →“Motor rated torque” on page 6-231

Name	Torque constant	
Index	0x3001	
Subindex	0x05	
Data type	UNSIGNED32	
Access type	RW	
Default value	0	
Value range	0	10'000'000
PDO mapping	NO	
Backup	YES	

## 6.2.54 Electrical system parameters

The parameters are evaluated during the auto tuning identification of the electrical system. They are used during the auto tuning identification of the mechanical system to calculate the torque constant as well as for the sensor supervision.

Name	Electrical system parameters
Index	0x3002
Object code	RECORD
Highest subindex supported	2

### 6.2.54.1 Electrical resistance

Represents the electrical system resistance. The value is given in [mΩ].

Name	Electrical resistance
Index	0x3002
Subindex	0x01
Data type	UNSIGNED32
Access type	RW
Default value	0
Value range	0 4'294'967'295
PDO mapping	NO
Backup	YES

### 6.2.54.2 Electrical inductance

Represents the electrical system inductance. The value is given in [μH].

Name	Electrical inductance
Index	0x3002
Subindex	0x02
Data type	UNSIGNED16
Access type	RW
Default value	0
Value range	0 65'535
PDO mapping	NO
Backup	YES

## 6.2.55 Gear configuration

Used to setup configuration of a gear. A gear can only be used if the corresponding value of →Axis configuration (→Control structure) has been configured (not “none”).

Write access is only permitted in device state «Power Disable».

Related object: →“Axis configuration” on page 6-138

Name	Gear configuration
Index	0x3003
Object code	RECORD
Highest subindex supported	4

### 6.2.55.1 Gear reduction numerator

The absolute gear reduction is calculated by division of gear reduction numerator by gear reduction denominator. It is also the ratio of input speed/turns as well as output speed/turns of a gear.

For detailed gear specifications →maxon catalog.

Name	Gear reduction numerator	
Index	0x3003	
Subindex	0x01	
Data type	UNSIGNED32	
Access type	RW	
Default value	1	
Value range	1	4'294'967'295
PDO mapping	NO	
Backup	YES	

### 6.2.55.2 Gear reduction denominator

The absolute gear reduction is calculated by division of gear reduction numerator by gear reduction denominator. It is also the ratio of input speed/turns as well as output speed/turns of a gear.

For detailed gear specifications →maxon catalog.

Name	Gear reduction denominator	
Index	0x3003	
Subindex	0x02	
Data type	UNSIGNED32	
Access type	RW	
Default value	1	
Value range	1	4'294'967'295
PDO mapping	NO	
Backup	YES	

### 6.2.55.3 Max gear input speed

Indicates the configured maximal allowed input speed for the gear. It serves as protection of the gear. Together with the →Max motor speed, it limits the gear's output speed. The value is given in [rpm].

For detailed gear specifications →maxon catalog.

Write access is permitted in device state «Power Enabled».

Related objects: →“Max profile velocity” on page 6-235 / →“Axis configuration” on page 6-138

Name	Max gear input speed		
Index	0x3003		
Subindex	0x03		
Data type	UNSIGNED32		
Access type	RW		
Default value	100'000		
Value range	1		100'000
PDO mapping	NO		
Backup	YES		

Velocity limit		Max motor speed greater Max gear input speed	Max motor speed lower or equal Max gear input speed
Gear	no	Max motor speed	Max motor speed
	yes	$\frac{\text{Max gear input speed}}{\text{Absolute gear reduction}}$	$\frac{\text{Max motor speed}}{\text{Absolute gear reduction}}$

Table 6-115 Gear velocity limits

### 6.2.55.4 Gear miscellaneous configuration

Used to define various options regarding the gear configuration.

Name	Gear miscellaneous configuration		
Index	0x3003		
Subindex	0x04		
Data type	UNSIGNED32		
Access type	RW		
Default value	0		
Value range	→Table 6-116		
PDO mapping	NO		
Backup	YES		

Bit	Name	Value	Description
31...1	reserved	0	–
0	Gear direction	0	Normal (rotational direction of input and output are the same)
		1	Inverted (rotational direction of input and output are opposite)

Table 6-116 Gear miscellaneous configuration – Bits

## 6.2.56 Digital incremental encoder 1

Defines the configuration of the digital incremental encoder 1.

Name	Digital incremental encoder 1
Index	0x3010
Object code	RECORD
Highest subindex supported	4

### 6.2.56.1 Digital incremental encoder 1 number of pulses

Defines the resolution of the digital incremental encoder 1. The value is given in [pulses/revolution]. Unit conversion is as follows:

$$4 \times \frac{\text{pulses}}{\text{revolutions}} = \frac{\text{increments}[\text{inc}]}{\text{revolutions}[\text{rev}]} = \frac{\text{quadcounts}[\text{qc}]}{\text{revolutions}[\text{rev}]}$$

Write access is only permitted in device state «Power Disable».

Name	Digital incremental encoder 1 number of pulses	
Index	0x3010	
Subindex	0x01	
Data type	UNSIGNED32	
Access type	RW	
Default value	500	
Value range	16	2'500'000
PDO mapping	NO	
Backup	YES	



**6.2.56.2 Digital incremental encoder 1 type**

Defines the configuration of the digital incremental encoder 1.

Write access is only permitted in device state «Power Disable».

Name	Digital incremental encoder 1 type
Index	0x3010
Subindex	0x02
Data type	UNSIGNED16
Access type	RW
Default value	0x0001
Value range	→Table 6-117
PDO mapping	NO
Backup	YES

Bit	Name	Value	Description
15...10	reserved	0	–
9	Method	0	Speed measured as time between two consecutive sensor edges
		1	Speed measured as number of sensor edges per control cycle
8...5	reserved	0	–
4	Direction	0	maxon
		1	Inverted (or encoder mounted on motor shaft)
3...2	reserved	0	–
1...0	Index	0	Encoder without index (2-channel)
		1	Encoder with index (3-channel)
		2	reserved
		3	Encoder with index (3-channel, without index supervision)

Table 6-117 Digital incremental encoder 1 type – Bits

**6.2.56.3 Digital incremental encoder 1 index position**

Holds the digital incremental encoder 1 position reached upon last detected encoder index pulse. The value is given in [increments].

Name	Digital incremental encoder 1 index position
Index	0x3010
Subindex	0x04
Data type	INTEGER32
Access type	RO
Default value	–
Value range	–
PDO mapping	TXPDO
Backup	NO

## 6.2.57 Analog incremental encoder

**The object is not available with...**

- «EPOS4 Disk 60/8»
- «EPOS4 Disk 60/12»
- «EPOS4 Micro 24/5»

Defines the configuration of the analog incremental encoder SinCos. Make sure to activate the encoder for the respective axis using →Axis configuration.

Write access is only permitted if the corresponding axis is in device state «Power Disable».

Related object: →“Axis configuration” on page 6-138

Name	Analog incremental encoder
Index	0x3011
Object code	RECORD
Highest subindex supported	3

### 6.2.57.1 Analog incremental encoder type

Defines the configuration of the analog incremental encoder SinCos.

Name	Analog incremental encoder type
Index	0x3011
Subindex	0x01
Data type	UNSIGNED16
Access type	RW
Default value	0x0001
Value range	→Table 6-118
PDO mapping	NO
Backup	YES

Bit	Name	Value	Description
15...5	reserved	0	–
4	Direction	0	maxon
		1	Inverted (or encoder mounted on motor shaft)
3...1	reserved	0	–
0	Index	0	Encoder without index (2-channel)
		1	Encoder with index (3-channel)

Table 6-118 Analog incremental encoder type – Bits

### 6.2.57.2 Analog incremental encoder resolution

Defines the resolution of the analog incremental encoder SinCos. Use “Number of periods” (bits 31...8) to set the Analog incremental encoder SinCos’ number of periods per turn. Use “Interpolation bits” (bits 7...0) to define the desired interpolation within a period. Hence, the resolution yields as follows:

$$Resolution = 2^{InterpolationBits} \cdot PeriodsPerTurn \left[ \frac{inc}{rev} \right]$$

Thereby, the following boundaries apply:

$$MaxResolution = 2^{InterpolationBits} \cdot PeriodsPerTurn \leq 10'000'000 \left[ \frac{inc}{rev} \right]$$

$$MinResolution = 2^{InterpolationBits} \cdot PeriodsPerTurn \geq 64 \left[ \frac{inc}{rev} \right]$$

Name	Analog incremental encoder resolution
Index	0x3011
Subindex	0x02
Data type	UNSIGNED32
Access type	RW
Default value	0x00080004
Value range	→Table 6-119
PDO mapping	NO
Backup	YES

Bit	Name	Default	Min	Max
31...8	Number of periods	2'048	1	2'500'000
7...0	Interpolation bits	4	2	10

Table 6-119 Analog incremental encoder resolution – Bits

### 6.2.57.3 Analog incremental encoder index position

Holds the analog incremental encoder SinCos’ position reached upon last detected encoder index pulse. The value is given in [increments].

Name	Analog incremental encoder index position		
Index	0x3011		
Subindex	0x03		
Data type	INTEGER32		
Access type	RO		
Default value	–		
Value range	–	–	
PDO mapping	TXPDO		
Backup	NO		

## 6.2.58 SSI absolute encoder

Defines the configuration of the SSI absolute encoder. Make sure to activate the SSI absolute encoder for the respective axis using →“Axis configuration” on page 6-138.

Write access is only permitted if the corresponding axis is in state «Power Disable».

A virtual index pulse is generated at value “0” (zero) of single turn part of the raw value. The virtual index can be used for homing or touch probe.

Name	SSI absolute encoder
Index	0x3012
Object code	RECORD
Highest subindex supported	13

### 6.2.58.1 SSI data rate

Represents the SSI encoder data rate (SSI clock frequency). The value is given in [kbit/s].

The maximal data rate depends on the actual cable length and the configuration of the encoder. For the correlation between cable length and data rate →Figure 6-43. Use cables with twisted pairs.

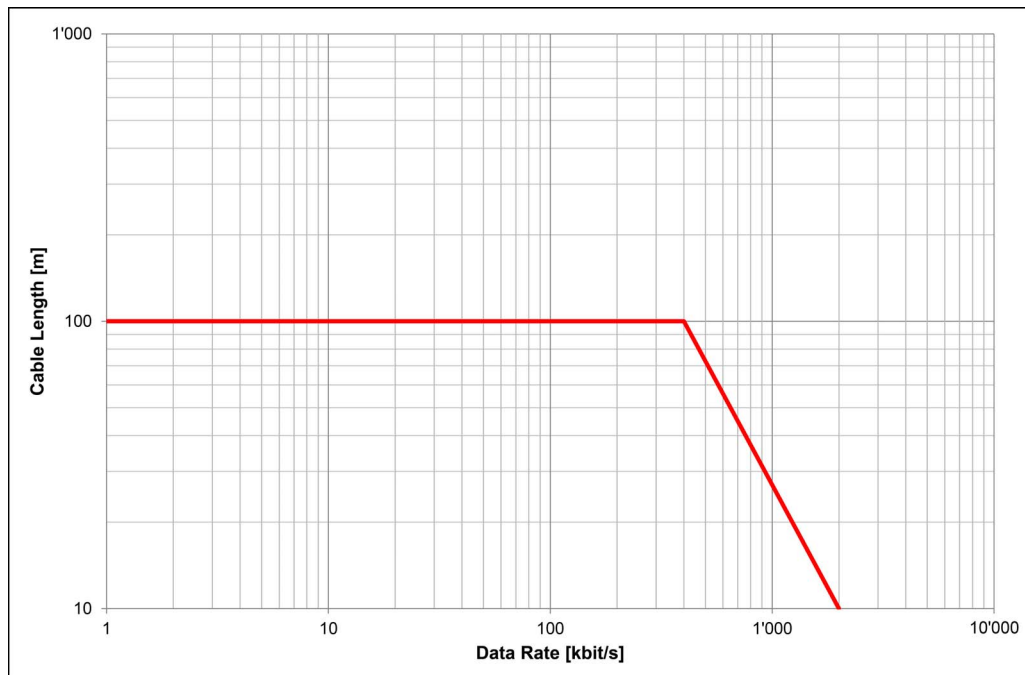

Figure 6-43 SSI encoder – Data rate vs. cable length

Name	SSI data rate	
Index	0x3012	
Subindex	0x01	
Data type	UNSIGNED16	
Access type	RW	
Default value	2'000	
Value range	400	2'000
PDO mapping	NO	
Backup	YES	

### 6.2.58.2 SSI number of data bits

Defines the number of multi-turn, single-turn, and special bits of the SSI data frame. The maximum value combined is 62 (including special bits → Figure 6-44).

Related object: →“SSI position bits” on page 6-166

Name	SSI number of data bits
Index	0x3012
Subindex	0x02
Data type	UNSIGNED32
Access type	RW
Default value	0x00000C00
Value range	→Table 6-120
PDO mapping	NO
Backup	YES

Bit	Name	Default	Min	Max
31...24	Special bits leading	0	0	16
23...16	Multi-turn bits	0	0	32
15...8	Single-turn bits	12	6	32
7...0	Special bits trailing	0	0	16

Table 6-120 SSI encoder – Number of data bits



Figure 6-44 SSI encoder – Data frame

### 6.2.58.3 SSI encoding type

Defines the type of SSI encoding.

Name	SSI encoding type
Index	0x3012
Subindex	0x03
Data type	UNSIGNED16
Access type	RW
Default value	0x001
Value range	→Table 6-121
PDO mapping	NO
Backup	YES

Bit	Name	Value	Description	Default
15...10	reserved	0	—	0
9	Reference reset	0	No reference reset on frame error	0
		1	Reset referenced flag on frame error (→Statusword)	
8	Check frame	0	No frame checking	0
		1	Frame start and end bit checking	
7...5	reserved	0	—	0
4	Direction	0	maxon	0
		1	Inverted (or encoder mounted on motor shaft)	
3...0	Encoding type	0	Binary coded data	0
		1	Gray coded data	
		—	reserved	

Table 6-121 SSI encoder – Protocol

**6.2.58.4 SSI timeout time**

Represents the minimal duration after the last clock edge of a sequence until the first clock edge of the next sequence (→Figure 6-45). The value is given in [μs].

Name	SSI timeout time	
Index	0x3012	
Subindex	0x05	
Data type	UNSIGNED16	
Access type	RW	
Default value	30	
Value range	0	50
PDO mapping	NO	
Backup	YES	

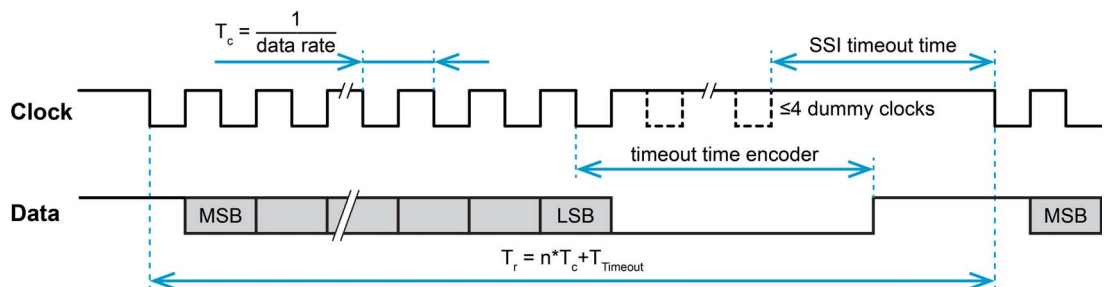

Figure 6-45 SSI encoder – Timing

**6.2.58.5 SSI special bits trailing data**

The trailing special bits of the SSI data frame will be copied to this object if the number of special bits trailing >0 (→Table 6-120). In the device, no additional processing of the special bits will take place, thus, subsequent processing must be handled by the superior application.

Name	SSI special bits trailing data	
Index	0x3012	
Subindex	0x06	
Data type	UNSIGNED16	
Access type	RO	
Default value	-	
Value range	-	-
PDO mapping	YES	
Backup	NO	

**6.2.58.6 SSI refresh frequency**

Displays the momentarily used refresh frequency. The maximal refresh frequency is  $1/Tr$ . However, this can be smaller depending on the device's internal timings conditions (→ Figure 6-45). The value is given in [Hz]; typically are 25'000, 12'500, 5'000.

Related object: → "SSI absolute encoder" on page 6-160

Name	SSI refresh frequency	
Index	0x3012	
Subindex	0x07	
Data type	UNSIGNED32	
Access type	RO	
Default value	–	
Value range	–	–
PDO mapping	NO	
Backup	NO	

**6.2.58.7 SSI power up time**

Defines the duration from power-up until the SSI encoder is initialized and ready for operation. The value is given in [ms].

Name	SSI power up time	
Index	0x3012	
Subindex	0x08	
Data type	UNSIGNED16	
Access type	RW	
Default value	200	
Value range	0	10'000
PDO mapping	NO	
Backup	YES	

**6.2.58.8 SSI position raw value**

Represents the lower 32 bit part of the actual SSI absolute position raw value derived directly by the encoder (right aligned). The value is given in [increments].

Name	SSI position raw value	
Index	0x3012	
Subindex	0x09	
Data type	UNSIGNED32	
Access type	RO	
Default value	–	
Value range	–	–
PDO mapping	NO	
Backup	NO	



**6.2.58.9 SSI commutation offset value**

Represents the SSI absolute position offset value to align to the “0” (zero) angle position for commutation purposes. The SSI commutation offset [0...encoder resolution] represents [0°...360°].

For detailed information see separate document → «EPOS4 Application Notes»; section “Adjustment of SSI Commutation Offset Value” (find a list of sources → chapter “1.1.6 Sources for additional Information” on page 1-12). The value is given in [increments].

Name	SSI commutation offset value	
Index	0x3012	
Subindex	0x0A	
Data type	UNSIGNED32	
Access type	RW	
Default value	0	
Value range	–	–
PDO mapping	NO	
Backup	YES	



**Encoder alignment**

- If you are using a maxon absolute encoder, the alignment is factory-set and the “SSI commutation offset value” does not require to be set.
- If you are using a third party absolute encoder, you must...
  - either ensure that the alignment follows the specified pattern (→ Figure 6-46)
  - or use the “SSI commutation offset value” to align the angle position.

**Signal Sequence of Hall Sensors**

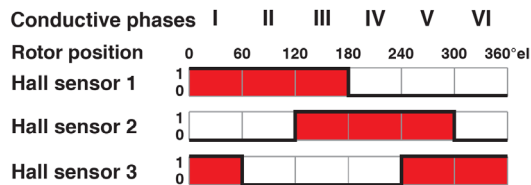

**Supplied Motor Voltage (Phase to Phase)**

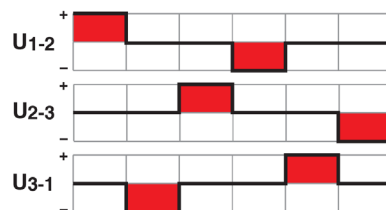

Figure 6-46 Block commutation of EC (BLDC) motors – Definition of phases

**6.2.58.10 SSI position bits**

Unlike the SSI encoder's maximal data length of 62 bit (→“SSI number of data bits” on page 6-161), the position format of the device has a maximum length of 32 bits. Hence, the number of data bits used by the SSI encoder must be reduced, if the sum exceeds 32 multi-turn/single-turn bits.

Among other instances, the number of single-turn bits is also used for calculation of the actual speed. The resolution for rotary encoders is as follows:

$$Resolution = 2^{\text{Single-turn bits}} \left[ \frac{inc}{rev} \right]$$

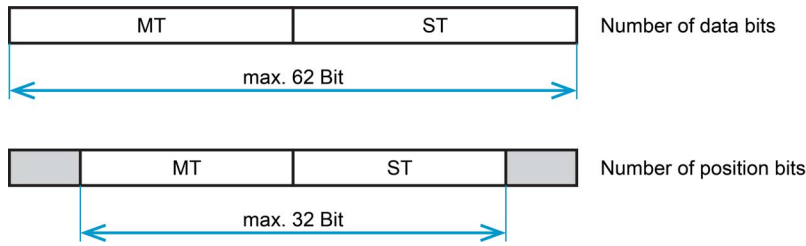

Figure 6-47 SSI encoder – Data bits

Name	SSI position bits
Index	0x3012
Subindex	0x0B
Data type	UNSIGNED32
Access type	RW
Default value	0x0000000C
Value range	→Table 6-122
PDO mapping	NO
Backup	YES

Bit	Name	Min	Max
31...16	reserved	–	–
15...8	Multi-turn bits	0	26
7...0	Single-turn bits	6	31

Table 6-122 SSI position bits

**6.2.58.11 SSI special bits leading data**

The leading special bits of the SSI data frame will be copied to this object if the number of special bits leading >0 (→ Table 6-120). In the device, no additional processing of special bits will take place, thus, subsequent processing must be handled by the superior application.

Name	SSI special bits leading data	
Index	0x3012	
Subindex	0x0C	
Data type	UNSIGNED16	
Access type	RO	
Default value	–	
Value range	–	–
PDO mapping	YES	
Backup	NO	

**6.2.58.12 SSI position raw value complete**

Represents the actual SSI absolute position raw value [MT, ST] derived directly by the encoder. The value is given in [increments].

Name	SSI position raw value complete	
Index	0x3012	
Subindex	0x0D	
Data type	UNSIGNED64	
Access type	RO	
Default value	–	
Value range	–	–
PDO mapping	NO	
Backup	NO	

## 6.2.59 Digital Hall sensor

Defines the configuration of the digital Hall sensor. Make sure to activate the digital Hall sensor for the respective axis using →“Axis configuration” on page 6-138.

Name	Digital Hall sensor
Index	0x301A
Object code	RECORD
Highest subindex supported	2

### 6.2.59.1 Digital Hall sensor type

Defines the configuration of the digital Hall sensor.

Write access is only permitted in device state «Power Disable».

Name	Digital Hall sensor type
Index	0x301A
Subindex	0x01
Data type	UNSIGNED16
Access type	RW
Default value	0
Value range	→Table 6-123
PDO mapping	NO
Backup	YES

Bit	Name	Value	Description
15...5	reserved	–	–
4	Method	0	Speed measured as time between two consecutive sensor edges
		1	Speed measured as number of sensor edges per control cycle
3...1	reserved	–	–
0	Polarity	0	maxon
		1	Inverted

Table 6-123 Digital Hall sensor – Bits

**6.2.59.2 Digital Hall sensor pattern**

Displays the actual state of the three digital Hall sensors as a pattern.

Name	Digital Hall sensor pattern	
Index	0x301A	
Subindex	0x02	
Data type	UNSIGNED16	
Access type	RO	
Default value	–	
Value range	–	–
PDO mapping	NO	
Backup	NO	

Bit	Hardware Signal
2	Digital Hall sensor 3
1	Digital Hall sensor 2
0	Digital Hall sensor 1

Table 6-124 Digital Hall sensor – Pattern

## 6.2.60 Digital incremental encoder 2

**The object is not available with...**

- «EPOS4 Disk 60/8»
- «EPOS4 Disk 60/12»
- «EPOS4 Micro 24/5»

Defines the configuration of the digital incremental encoder 2.

Name	Digital incremental encoder 2
Index	0x3020
Object code	RECORD
Highest subindex supported	4

### 6.2.60.1 Digital incremental encoder 2 number of pulses

Defines the resolution of the digital incremental encoder 2. The value is given in [pulses/revolution]. Unit conversion is as follows:

$$4 \times \frac{\text{pulses}}{\text{revolutions}} = \frac{\text{increments}[\text{inc}]}{\text{revolutions}[\text{rev}]} = \frac{\text{quadcounts}[\text{qc}]}{\text{revolutions}[\text{rev}]}$$

Write access is only permitted in device state «Power Disable».

Name	Digital incremental encoder 2 number of pulses	
Index	0x3020	
Subindex	0x01	
Data type	UNSIGNED32	
Access type	RW	
Default value	500	
Value range	16	2'500'000
PDO mapping	NO	
Backup	YES	

**6.2.60.2 Digital incremental encoder 2 type**

Defines the configuration of the digital incremental encoder 2.

Write access is only permitted in device state «Power Disable».

Name	Digital incremental encoder 2 type
Index	0x3020
Subindex	0x02
Data type	UNSIGNED16
Access type	RW
Default value	0x0001
Value range	→Table 6-125
PDO mapping	NO
Backup	YES

Bit	Name	Value	Description
15...10	reserved	0	–
9	Method	0	Speed measured as time between two consecutive sensor edges
		1	Speed measured as number of sensor edges per control cycle
8...5	reserved	0	–
4	Direction	0	maxon
		1	Inverted (or encoder mounted on motor shaft)
3...2	reserved	0	–
1...0	Index	0	Encoder without index (2-channel)
		1	Encoder with index (3-channel)
		2	reserved
		3	Encoder with index (3-channel, without index supervision)

Table 6-125 Digital incremental encoder 2 type – Bits

**6.2.60.3 Digital incremental encoder 2 index position**

Holds the digital incremental encoder 2 position reached upon last detected encoder index pulse. The value is given in [increments].

Name	Digital incremental encoder 2 index position
Index	0x3020
Subindex	0x04
Data type	INTEGER32
Access type	RO
Default value	–
Value range	–
PDO mapping	TXPDO
Backup	NO

## 6.2.61 Current control parameter set

Holds the current controller parameters. The current controller is realized with a digital PI controller.

Name	Current control parameter set
Index	0x30A0
Object code	RECORD
Highest subindex supported	2

### 6.2.61.1 Current controller P gain

Represents the proportional gain of the current controller. The value is given in  $[\frac{\mu V}{A}]$ .

Name	Current controller P gain	
Index	0x30A0	
Subindex	0x01	
Data type	UNSIGNED32	
Access type	RW	
Default value	1'171'880	
Value range	–	–
PDO mapping	RXPDO	
Backup	YES	

### 6.2.61.2 Current controller I gain

Represents the integral gain of the current controller. The value is given in  $[\frac{\mu V}{A \cdot ms}]$ .

Name	Current controller I gain	
Index	0x30A0	
Subindex	0x02	
Data type	UNSIGNED32	
Access type	RW	
Default value	3'906'250	
Value range	–	–
PDO mapping	RXPDO	
Backup	YES	



## 6.2.62 Position control parameter set

Holds the position controller parameters. The position controller is realized with a digital PID controller.

Name	Position control parameter set
Index	0x30A1
Object code	RECORD
Highest subindex supported	9

### 6.2.62.1 Position controller P gain

Represents the proportional gain of the position controller. The value is given in  $[\frac{\mu A}{rad}]$ .

Name	Position controller P gain
Index	0x30A1
Subindex	0x01
Data type	UNSIGNED32
Access type	RW
Default value	1'500'000
Value range	–
PDO mapping	RXPDO
Backup	YES

### 6.2.62.2 Position controller I gain

Represents the integral gain of the position controller. The value is given in →SI unit position controller I gain (0x30A1; 0x09).

#### Reconfirm values when importing/exporting parameters

Prior to the firmware release 0x0170h, the position controller I gain has been given in  $[-\frac{\mu A}{rad \cdot s}]$ .

Make sure to consider this fact and check for correct values when importing/exporting a parameter file from/to firmware older than 0x0170h.

Name	Position controller I gain
Index	0x30A1
Subindex	0x02
Data type	UNSIGNED32
Access type	RW
Default value	780'000
Value range	–
PDO mapping	RXPDO
Backup	YES

### 6.2.62.3 Position controller D gain

Represents the differential gain of the position controller. The value is given in  $[\frac{\mu A \cdot s}{rad}]$ .

Name	Position controller D gain
Index	0x30A1
Subindex	0x03
Data type	UNSIGNED32
Access type	RW
Default value	16'000
Value range	–
PDO mapping	RXPDO
Backup	YES

### 6.2.62.4 Position controller FF velocity gain

Represents the speed feedforward gain of the position controller. The value is given in  $[\frac{\mu A \cdot s}{rad}]$ .

Name	Position controller FF velocity gain
Index	0x30A1
Subindex	0x04
Data type	UNSIGNED32
Access type	RW
Default value	0
Value range	–
PDO mapping	RXPDO
Backup	YES

### 6.2.62.5 Position controller FF acceleration gain

Represents the acceleration feedforward gain of the position controller. The value is given in  $[\frac{\mu A \cdot s^2}{rad}]$ .

Name	Position controller FF acceleration gain
Index	0x30A1
Subindex	0x05
Data type	UNSIGNED32
Access type	RW
Default value	0
Value range	–
PDO mapping	RXPDO
Backup	YES

**6.2.62.6 SI unit position controller I gain**

Represents the SI units of the →Position controller I gain (0x30A1; 0x02). Coding of the user-defined units and prefixes follows →chapter “2.3.1 SI Units” on page 2-19.

Name	SI unit position controller I gain		
Index	0x30A1		
Subindex	0x09		
Data type	UNSIGNED32		
Access type	RW		
Default value	0xFA040300		
Value range	–		–
PDO mapping	RXPDO		
Backup	YES		

Bit 31...24	Bit 23...16	Bit 15...8	Bit 7...0
Prefix	Numerator	Denominator	reserved (0)

Table 6-126 SI units velocity – Bits

Value	Description	Symbol
0xFA040300	micro ampere / radian second	$\frac{\mu A \cdot s}{rad}$
0xFD040300	milli ampere / radian second	$\frac{mA \cdot s}{rad}$

Table 6-127 SI units velocity – Value range

### 6.2.63 Velocity control parameter set

Velocity regulation is implemented with a digital PI controller. The object holds all parameters of the velocity controller.

Name	Velocity control parameter set
Index	0x30A2
Object code	RECORD
Highest subindex supported	5

#### 6.2.63.1 Velocity controller P gain

Represents the proportional gain of the velocity controller. The value is given in  $[\frac{\mu A \cdot s}{rad}]$ .

Name	Velocity controller P gain
Index	0x30A2
Subindex	0x01
Data type	UNSIGNED32
Access type	RW
Default value	20'000
Value range	–
PDO mapping	RXPDO
Backup	YES

#### 6.2.63.2 Velocity controller I gain

Represents the integral gain of the velocity controller. The value is given in  $[\frac{\mu A}{rad}]$ .

Name	Velocity controller I gain
Index	0x30A2
Subindex	0x02
Data type	UNSIGNED32
Access type	RW
Default value	500'000
Value range	–
PDO mapping	RXPDO
Backup	YES

**6.2.63.3 Velocity controller FF velocity gain**

Represents the speed feedforward gain of the velocity controller. The value is given in  $[\frac{\mu A \cdot s}{rad}]$ .

Name	Velocity controller FF velocity gain	
Index	0x30A2	
Subindex	0x03	
Data type	UNSIGNED32	
Access type	RW	
Default value	0	
Value range	–	–
PDO mapping	RXPDO	
Backup	YES	

**6.2.63.4 Velocity controller FF acceleration gain**

Represents the acceleration feedforward gain of the velocity controller. The value is given in  $[\frac{\mu A \cdot s^2}{rad}]$ .

Name	Velocity controller FF acceleration gain	
Index	0x30A2	
Subindex	0x04	
Data type	UNSIGNED32	
Access type	RW	
Default value	0	
Value range	–	–
PDO mapping	RXPDO	
Backup	YES	

**6.2.63.5 Velocity controller filter cut-off frequency**

Represents the velocity low pass filter cut-off frequency of the velocity controller. The value is given in [Hz].

Name	Velocity controller filter cut-off frequency	
Index	0x30A2	
Subindex	0x05	
Data type	UNSIGNED16	
Access type	RW	
Default value	600	
Value range	1	10'000
PDO mapping	NO	
Backup	YES	

## 6.2.64 Velocity observer parameter set

Velocity observation is implemented with a digital disturbance observer. The object holds all parameters of the velocity observer.

Name	Velocity observer parameter set
Index	0x30A3
Object code	RECORD
Highest subindex supported	5

### 6.2.64.1 Velocity observer position correction gain

Represents the position correction gain of the velocity observer. The value is given in [%].

Name	Velocity observer position correction gain
Index	0x30A3
Subindex	0x01
Data type	UNSIGNED32
Access type	RW
Default value	400
Value range	–
PDO mapping	RXPDO
Backup	YES

### 6.2.64.2 Velocity observer velocity correction gain

Represents the velocity correction gain of the velocity observer. The value is given in [mHz].

Name	Velocity observer velocity correction gain
Index	0x30A3
Subindex	0x02
Data type	UNSIGNED32
Access type	RW
Default value	100'000
Value range	–
PDO mapping	RXPDO
Backup	YES

**6.2.64.3 Velocity observer load correction gain**

Represents the load correction gain of the velocity observer. The value is given in  $[\frac{\mu Nm}{rad}]$ .

Name	Velocity observer load correction gain	
Index	0x30A3	
Subindex	0x03	
Data type	UNSIGNED32	
Access type	RW	
Default value	33	
Value range	–	–
PDO mapping	RXPDO	
Backup	YES	

**6.2.64.4 Velocity observer friction**

Represents the velocity observer friction. The value is given in  $[0.001 \cdot \frac{\mu Nm}{rpm}]$ .

Name	Velocity observer friction	
Index	0x30A3	
Subindex	0x04	
Data type	UNSIGNED32	
Access type	RW	
Default value	10	
Value range	–	–
PDO mapping	RXPDO	
Backup	YES	

**6.2.64.5 Velocity observer inertia**

Represents the velocity observer inertia. The value is given in  $[0.001 g \cdot cm^2]$ .

Name	Velocity observer inertia	
Index	0x30A3	
Subindex	0x05	
Data type	UNSIGNED32	
Access type	RW	
Default value	1000	
Value range	–	–
PDO mapping	RXPDO	
Backup	YES	

## 6.2.65 Dual loop position control parameter set

Dual loop position control is implemented with a P main loop (outer loop) controller, a gain scheduler, additional filters, and an auxiliary loop (inner loop) PI speed controller with velocity observer. The object holds all mandatory parameters for the configuration.

Name	Dual loop position control parameter set
Index	0x30AE
Object code	RECORD
Highest subindex supported	64

### 6.2.65.1 Main loop P gain low bandwidth

Represents the main loop low bandwidth proportional factor. The value is given in  $[\frac{10^{-3}}{s}]$ .

Name	Main loop P gain low bandwidth
Index	0x30AE
Subindex	0x01
Data type	UNSIGNED32
Access type	RW
Default value	10'000
Value range	0 <span style="float: right;">10<sup>9</sup></span>
PDO mapping	RXPDO
Backup	YES

### 6.2.65.2 Main loop P gain high bandwidth

Represents the main loop high bandwidth proportional factor. The value is given in  $[\frac{10^{-3}}{s}]$ .

Name	Main loop P gain high bandwidth
Index	0x30AE
Subindex	0x02
Data type	UNSIGNED32
Access type	RW
Default value	100'000
Value range	0 <span style="float: right;">10<sup>9</sup></span>
PDO mapping	RXPDO
Backup	YES



**6.2.65.3 Main loop gain scheduling weight**

Represents the main loop gain scheduler. The value is given in  $[10^{-3}]$ .

Name	Main loop gain scheduling weight	
Index	0x30AE	
Subindex	0x03	
Data type	UNSIGNED16	
Access type	RW	
Default value	12'500	
Value range	5'000	20'000
PDO mapping	RXPDO	
Backup	YES	

**6.2.65.4 Main loop filter coefficient a**

Represents the main loop filter coefficient A. The value is given in  $[10^{-3}]$ .

The internal filter coefficients are not updated until the filter update bit in →Dual loop configuration miscellaneous (0x30AE; 0x40) is written.

Name	Main loop filter coefficient a	
Index	0x30AE	
Subindex	0x10	
Data type	UNSIGNED32	
Access type	RW	
Default value	1'000	
Value range	0	$10^9$
PDO mapping	RXPDO	
Backup	YES	

**6.2.65.5 Main loop filter coefficient b**

Represents the main loop filter coefficient B. The value is given in  $[10^{-3}]$ .

The internal filter coefficients are not updated until the filter update bit in →Dual loop configuration miscellaneous (0x30AE; 0x40) is written.

Name	Main loop filter coefficient b	
Index	0x30AE	
Subindex	0x11	
Data type	UNSIGNED32	
Access type	RW	
Default value	1'000	
Value range	0	$10^9$
PDO mapping	RXPDO	
Backup	YES	

### 6.2.65.6 Main loop filter coefficient c

Represents the main loop filter coefficient C. The value is given in  $[10^{-3}]$ .

The internal filter coefficients are not updated until the filter update bit in →Dual loop configuration miscellaneous (0x30AE; 0x40) is written.

Name	Main loop filter coefficient c	
Index	0x30AE	
Subindex	0x12	
Data type	UNSIGNED32	
Access type	RW	
Default value	1'000	
Value range	0	$10^9$
PDO mapping	RXPDO	
Backup	YES	

### 6.2.65.7 Main loop filter coefficient d

Represents the main loop filter coefficient D. The value is given in  $[10^{-3}]$ .

The internal filter coefficients are not updated until the filter update bit in →Dual loop configuration miscellaneous (0x30AE; 0x40) is written.

Name	Main loop filter coefficient d	
Index	0x30AE	
Subindex	0x13	
Data type	UNSIGNED32	
Access type	RW	
Default value	1'000	
Value range	0	$10^9$
PDO mapping	RXPDO	
Backup	YES	

### 6.2.65.8 Main loop filter coefficient e

Represents the main loop filter coefficient E. The value is given in  $[10^{-3}]$ .

The internal filter coefficients are not updated until the filter update bit in →Dual loop configuration miscellaneous (0x30AE; 0x40) is written.

Name	Main loop filter coefficient e	
Index	0x30AE	
Subindex	0x14	
Data type	UNSIGNED32	
Access type	RW	
Default value	1'000	
Value range	0	$10^9$
PDO mapping	RXPDO	
Backup	YES	

**6.2.65.9 Auxiliary loop P gain**

Represents the proportional gain of the auxiliary loop velocity controller. The value is given in  $[\frac{\mu A \cdot s}{rad}]$ .

Name	Auxiliary loop P gain	
Index	0x30AE	
Subindex	0x20	
Data type	UNSIGNED32	
Access type	RW	
Default value	20'000	
Value range	–	–
PDO mapping	RXPDO	
Backup	YES	

**6.2.65.10 Auxiliary loop I gain**

Represents the integral gain of the auxiliary loop velocity controller. The value is given in  $[\frac{\mu A}{rad}]$ .

Name	Auxiliary loop I gain	
Index	0x30AE	
Subindex	0x21	
Data type	UNSIGNED32	
Access type	RW	
Default value	500'000	
Value range	–	–
PDO mapping	RXPDO	
Backup	YES	

**6.2.65.11 Auxiliary loop FF velocity gain**

Represents the speed feedforward gain of the auxiliary loop velocity controller. The value is given in  $[\frac{\mu A \cdot s}{rad}]$ .

Name	Auxiliary loop FF velocity gain	
Index	0x30AE	
Subindex	0x22	
Data type	UNSIGNED32	
Access type	RW	
Default value	0	
Value range	–	–
PDO mapping	RXPDO	
Backup	YES	

### 6.2.65.12 Auxiliary loop FF acceleration gain

Represents the acceleration feedforward gain of the auxiliary loop velocity controller. The value is given in  $[\frac{\mu A \cdot s^2}{rad}]$ .

Name	Auxiliary loop FF acceleration gain	
Index	0x30AE	
Subindex	0x23	
Data type	UNSIGNED32	
Access type	RW	
Default value	0	
Value range	–	–
PDO mapping	RXPDO	
Backup	YES	

### 6.2.65.13 Auxiliary loop observer position correction gain

Represents the position correction gain of the auxiliary loop velocity observer. The value is given in [%].

Name	Auxiliary loop observer position correction gain	
Index	0x30AE	
Subindex	0x30	
Data type	UNSIGNED32	
Access type	RW	
Default value	400	
Value range	–	–
PDO mapping	RXPDO	
Backup	YES	

### 6.2.65.14 Auxiliary loop observer velocity correction gain

Represents the velocity correction gain of the auxiliary loop velocity observer. The value is given in [ $mHz$ ].

Name	Auxiliary loop observer velocity correction gain	
Index	0x30AE	
Subindex	0x31	
Data type	UNSIGNED32	
Access type	RW	
Default value	100'000	
Value range	–	–
PDO mapping	RXPDO	
Backup	YES	

**6.2.65.15 Auxiliary loop observer load correction gain**

Represents the load correction gain of the auxiliary loop velocity observer. The value is given in  $[\frac{\mu Nm}{rad}]$ .

Name	Auxiliary loop observer load correction gain	
Index	0x30AE	
Subindex	0x32	
Data type	UNSIGNED32	
Access type	RW	
Default value	33	
Value range	–	–
PDO mapping	RXPDO	
Backup	YES	

**6.2.65.16 Auxiliary loop observer friction**

Represents the auxiliary loop velocity observer friction. The value is given in  $[0.001 \cdot \frac{\mu Nm}{rpm}]$ .

Name	Auxiliary loop observer friction	
Index	0x30AE	
Subindex	0x33	
Data type	UNSIGNED32	
Access type	RW	
Default value	10	
Value range	–	–
PDO mapping	RXPDO	
Backup	YES	

**6.2.65.17 Auxiliary loop observer inertia**

Represents the auxiliary loop velocity observer inertia. The value is given in  $[mg \cdot cm^2]$ .

Name	Auxiliary loop observer inertia	
Index	0x30AE	
Subindex	0x34	
Data type	UNSIGNED32	
Access type	RW	
Default value	1'000	
Value range	–	–
PDO mapping	RXPDO	
Backup	YES	

### 6.2.65.18 Dual loop configuration miscellaneous

Used to define various options regarding the axis configuration.

Name	Dual loop configuration miscellaneous
Index	0x30AE
Subindex	0x40
Data type	UNSIGNED16
Access type	RW
Default value	0x0000
Value range	→Table 6-128
PDO mapping	RXPDO
Backup	YES

Bit	Name	Value	Description
15...2	reserved	0	–
1	Main loop filter active	1	Filter functionality is enabled
		0	Filter functionality is disabled
0	Main loop filter update	1	Writing a “1” forces an internal update of the filter coefficients. Always read as “0” (zero).
		0	Has no effect

Table 6-128 Dual loop configuration miscellaneous – Bits

### 6.2.66 Home position

Defines the position that will be set as zero position of the absolute position counter. The value is given in [position units] (→page 2-19).

Related object: →“Home offset move distance” on page 6-187

Name	Home position
Index	0x30B0
Subindex	0x00
Data type	INTEGER32
Access type	RW
Default value	0
Value range	–
PDO mapping	RXPDO
Backup	YES

### 6.2.67 Home offset move distance

Represents a moving distance in a homing procedure. It is useful to move away from a detected position (for example mechanical limit stop or limit switch) at the end of the homing sequence, thus preventing the axis from a border damage respectively limit switch error. The value is given in [position units] (→page 2-19).

Name	Home offset move distance	
Index	0x30B1	
Subindex	0x00	
Data type	INTEGER32	
Access type	RW	
Default value	0	
Value range	–	–
PDO mapping	NO	
Backup	YES	

### 6.2.68 Current threshold for homing mode

Used for homing methods «-1», «-2», «-3», and «-4». A mechanical border will be detected when the measured motor current rises above the specified threshold [mA].

Related object: →“Homing method” on page 6-238

Name	Current threshold for homing mode	
Index	0x30B2	
Subindex	0x00	
Data type	UNSIGNED16	
Access type	RW	
Default value	500	
Value range	–	Maximal value of →Output current limit
PDO mapping	RXPDO	
Backup	YES	

### 6.2.69 Current demand value

The set value for the current controller. The value is given in [mA].

Name	Current demand value	
Index	0x30D0	
Subindex	0x00	
Data type	INTEGER32	
Access type	RO	
Default value	–	
Value range	–	–
PDO mapping	TXPDO	
Backup	NO	

## 6.2.70 Current actual values

Provides the actual current values.

Name	Current actual values
Index	0x30D1
Object code	ARRAY
Highest subindex supported	2

### 6.2.70.1 Current actual value averaged

Represents the →“Current actual value” on page 6-188 filtered by 1<sup>st</sup> order digital low-pass filter with a cut-off frequency of 50 Hz. The value is given in [mA].

Name	Current actual value averaged
Index	0x30D1
Subindex	0x01
Data type	INTEGER32
Access type	RO
Default value	–
Value range	–
PDO mapping	TXPDO
Backup	NO

### 6.2.70.2 Current actual value

Provides the actual value of the motor's current. The value is given in [mA].

Name	Current actual value
Index	0x30D1
Subindex	0x02
Data type	INTEGER32
Access type	RO
Default value	–
Value range	–
PDO mapping	TXPDO
Backup	NO



## 6.2.71 Torque actual values

Provides the actual torque values.

Name	Torque actual values
Index	0x30D2
Object code	ARRAY
Highest subindex supported	1

### 6.2.71.1 Torque actual value averaged

Represents the →“Torque actual value” on page 6-231 filtered by 1<sup>st</sup> order digital low-pass filter with a cut-off frequency of 50 Hz. The value is given in  $[\frac{MotorRatedTorque}{1000}]$ .

Related object: →“Torque actual value” on page 6-231

Name	Torque actual value averaged	
Index	0x30D2	
Subindex	0x01	
Data type	INTEGER16	
Access type	RO	
Default value	–	
Value range	–	–
PDO mapping	TXPDO	
Backup	NO	

## 6.2.72 *Velocity actual values*

Provides the actual velocity values.

Name	Velocity actual values
Index	0x30D3
Object code	ARRAY
Highest subindex supported	1

### 6.2.72.1 *Velocity actual value averaged*

Represents the →“Velocity actual value” on page 6-230 filtered by 1<sup>st</sup> order digital low-pass filter with a cut-off frequency of 5 Hz.

Provides the actual averaged velocity value of the axis, derived by the main sensor defined in →“Axis configuration” on page 6-138. If no main sensor is configured, the velocity actual value is “0” (zero). The value is given in [velocity units] (→page 2-19).

Related objects: →“Velocity actual value” on page 6-230 / →“Additional velocity actual values” on page 6-258

Name	Velocity actual value averaged	
Index	0x30D3	
Subindex	0x01	
Data type	INTEGER32	
Access type	RO	
Default value	–	
Value range	–	–
PDO mapping	TXPDO	
Backup	NO	

## 6.2.73 Standstill window configuration

Configures the conditions to detect when the drive has come to a standstill. The functionality specifies the behavior of some device state machine transitions (→“Device Control” on page 2-16).

The following transitions are not performed until standstill condition is reached:

- «Operation Enable» → «Switch on disabled»
- «Operation Enable» → «Ready to switch on»
- «Operation Enable» → «Switched on»
- «Fault reaction active» → «Fault»

The slowdown behavior can be configured using the related objects.

Related objects: →“Abort connection option code” on page 6-219 / →“Shutdown option code” on page 6-224 / →“Disable operation option code” on page 6-224 / →“Fault reaction option code” on page 6-225

Name	Standstill window configuration
Index	0x30E0
Object code	RECORD
Highest subindex supported	3

### 6.2.73.1 Standstill window

Defines a symmetric range of accepted velocity values relatively to zero.

Standstill is reached, if the →“Velocity actual value averaged” on page 6-190 is within the standstill window (0x01) for the duration of the standstill window time (0x02). The value is given in [velocity units] (→page 2-19).

The value “4'294'967'295” ( $2^{32}-1$ ) switches off standstill detection and standstill is deemed to be reached at the end of the trajectory.

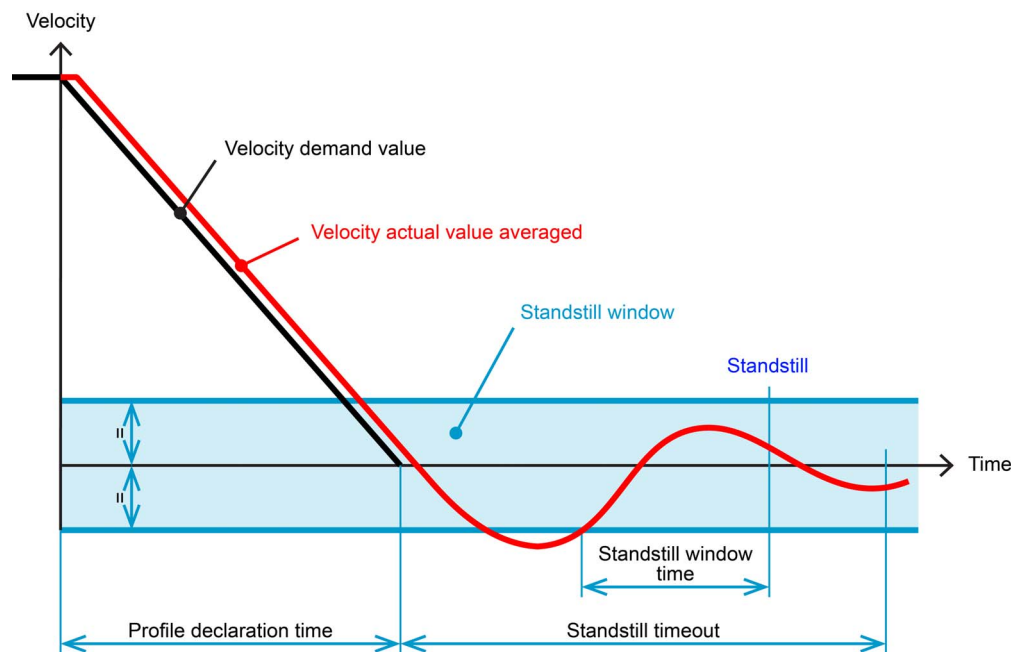

Figure 6-48 Standstill window

Continued on next page.

Name	Standstill window
Index	0x30E0
Subindex	0x01
Data type	UNSIGNED32
Access type	RW
Default value	30
Value range	–
PDO mapping	NO
Backup	YES

### 6.2.73.2 Standstill window time

Standstill is reached, if the → “Velocity actual value averaged” on page 6-190 is within the standstill window (0x01) for the duration of the standstill window time (0x02). The value is given in [ms].

Name	Standstill window time
Index	0x30E0
Subindex	0x02
Data type	UNSIGNED16
Access type	RW
Default value	2
Value range	–
PDO mapping	NO
Backup	YES

### 6.2.73.3 Standstill window timeout

Defines the point of time standstill is supposed to be reached, even if the standstill conditions are not yet fulfilled. This timeout may be used to prevent “hangs” in the device state machine in case the standstill window configuration or the velocity controller parameters are set inauspicious. The value is given in [ms].

The value “65'535” will disable the timeout.

Name	Standstill window timeout
Index	0x30E0
Subindex	0x03
Data type	UNSIGNED16
Access type	RW
Default value	1000
Value range	–
PDO mapping	NO
Backup	YES

## 6.2.74 Digital input properties

Related objects: →“Configuration of digital inputs” on page 6-195 / →“Digital inputs” on page 6-261

Name	Digital input properties
Index	0x3141
Object code	ARRAY
Highest subindex supported	2

### 6.2.74.1 Digital inputs logic state

Displays the state of the digital input logic signal (before polarity correction). A bit is read as “1” if the signal at the corresponding pin is high.

Name	Digital inputs logic state
Index	0x3141
Subindex	0x01
Data type	UNSIGNED16
Access type	RO
Default value	–
Value range	–
PDO mapping	TXPDO
Backup	NO

Bit	Default value
7	High-speed digital input 4
6	High-speed digital input 3 [a]
5	High-speed digital input 2 [a]
4	High-speed digital input 1 [a]
3	Digital input 4
2	Digital input 3
1	Digital input 2
0	Digital input 1
[a] Not available with «EPOS4 Disk 60/8» / «EPOS4 Disk 60/12» / «EPOS4 Micro 24/5»	

Table 6-129 Digital input bits

### 6.2.74.2 *Digital inputs polarity*

Used to set the polarity of the digital input functionalities. If a bit is set to “0” (zero), the associated pin is high active. For bit description → Table 6-129.

Name	Digital inputs polarity	
Index	0x3141	
Subindex	0x02	
Data type	UNSIGNED16	
Access type	RW	
Default value	0x0000	
Value range	–	–
PDO mapping	NO	
Backup	YES	

## 6.2.75 Configuration of digital inputs

Configures the functionality that will be assigned to digital inputs.

Related objects: →“Digital input properties” on page 6-193 / →“Digital inputs” on page 6-261

Name	Configuration of digital inputs
Index	0x3142
Object code	ARRAY
Highest subindex supported	8

### 6.2.75.1 Digital input configuration

Maps functions to digital inputs. Each function can only be mapped once, each digital input can only hold one function.

If a sensor 2 is configured (→“Sensors configuration” on page 6-138), the high-speed digital inputs 1 to 4 will be disabled. This configuration cannot be overridden as long as sensor 2 is configured.

Names	Digital input 1 configuration Digital input 2 configuration Digital input 3 configuration Digital input 4 configuration High-speed digital input 1 configuration [a] High-speed digital input 2 configuration [a] High-speed digital input 3 configuration [a] High-speed digital input 4 configuration
Index	0x3142
Subindex	0x01...0x08
Data type	UNSIGNED8
Access type	RW
Default value	→Table 6-130
Value range	→Table 6-130
PDO mapping	NO
Backup	YES

[a] Not available with «EPOS4 Disk 60/8» / «EPOS4 Disk 60/12» / «EPOS4 Micro 24/5»

Digital input	Default value
DgIn1	0: Negative limit switch
DgIn2	1: Positive limit switch
DgIn3	2: Home switch
DgIn4	19: General purpose D
HsDgIn1	255: none
HsDgIn2	255: none
HsDgIn3	255: none
HsDgIn4	255: none

Table 6-130 Digital inputs – Default values

Continued on next page.

Value	Functionality	Description
255	None	No functionality assigned
254...29	reserved	–
28	Quick stop	Stop movement and switch to «Quick stop active» state (→“Device Control” on page 2-16 for valid transitions)
27	Drive enable	Enable/disable the drive or clear errors in «Fault» state (→“Device Control” on page 2-16 for valid transitions)
26	Touch probe [a]	Samples actual position
25	Positive limit switch without errors	Used in homing mode with corresponding methods only, does not generate limit errors
24	Negative limit switch without errors	Used in homing mode with corresponding methods only, does not generate limit errors
23	General purpose H	State can be read
22	General purpose G	State can be read
21	General purpose F	State can be read
20	General purpose E	State can be read
19	General purpose D	State can be read
18	General purpose C	State can be read
17	General purpose B	State can be read
16	General purpose A	State can be read
15...3	reserved	–
2	Home switch	Used in some homing modes
1	Positive limit switch	Generates limit error except in homing mode with corresponding methods
0	Negative limit switch	Generates limit error except in homing mode with corresponding methods
[a] Not available with HsDigIn1 and HsDigIn3		

Table 6-131 Digital inputs – Configuration



## 6.2.76 Digital output properties

Related objects: →“Configuration of digital outputs” on page 6-198 / →“Digital outputs” on page 6-262

Name	Digital output properties
Index	0x3150
Object code	ARRAY
Highest subindex supported	2

### 6.2.76.1 Digital outputs logic state

Displays the digital output logic state (after polarity correction). A bit is read as “1” if the signal at the corresponding pin is high.

Name	Digital outputs logic state
Index	0x3150
Subindex	0x01
Data type	UNSIGNED16
Access type	RO
Default value	–
Value range	–
PDO mapping	TXPDO
Backup	NO

Bit	Description
3	High-speed digital output2 [a]
2	High-speed digital output1
1	Digital output 2
0	Digital output 1
[a] Available only with «EPOS4 Disk 60/8» / «EPOS4 Disk 60/12»	

Table 6-132 Digital output bits

### 6.2.76.2 Digital outputs polarity

Used to set the polarity of the digital outputs. If a bit is set to “1”, the associated output will be inverted, thus “1” in →“Digital outputs” on page 6-262” will set the output pin low.

For bit description →Table 6-132.

Name	Digital outputs polarity
Index	0x3150
Subindex	0x02
Data type	UNSIGNED16
Access type	RW
Default value	0x0000
Value range	–
PDO mapping	NO
Backup	YES

## 6.2.77 Configuration of digital outputs

Configures the functionality that will be assigned to the digital outputs.

Related objects: →“Digital output properties” on page 6-197 / →“Digital outputs” on page 6-262

Name	Configuration of digital outputs
Index	0x3151
Object code	ARRAY
Highest subindex supported	4: EPOS4 Disk 60/8 and EPOS4 Disk 60/12 3: Others

### 6.2.77.1 Digital output configuration

If a sensor 2 is configured (→“Sensors configuration” on page 6-138), the high-speed digital inputs 1 to 4 will be disabled. Disabling cannot be overridden as long as a sensor 2 is configured.

Names	Digital output 1 configuration Digital output 2 configuration High-speed digital output 1 configuration
Index	0x3151
Subindex	0x01...0x03
Data type	UNSIGNED8
Access type	RW
Default value	→Table 6-133
Value range	→Table 6-134
PDO mapping	NO
Backup	YES

Digital output	Default value
DigOut1	16: General purpose A
DigOut2	17: General purpose B
HsDigOut1	255: None

Table 6-133 Digital outputs – Default values

Value	Functionality	Description
255	None	No functionality assigned
254...26	reserved	–
25	Ready/Fault	Active on device ready / inactive on device fault state
24	Holding brake	Output functionality to drive a holding brake (for details see →“Holding brake parameters” on page 6-200)
23...19	reserved	–
18	General purpose C	State can be read/written by the host
17	General purpose B	State can be read/written by the host
16	General purpose A	State can be read/written by the host
15...1	reserved	–
0	Set brake (GPIO)	To drive a brake operated by the host in conformance to CiA 402 specification

Table 6-134 Digital outputs – Configuration

**6.2.77.2 High-speed digital output 2 configuration****The object is only available with...**

- «EPOS4 Disk 60/8»
- «EPOS4 Disk 60/12»

Names	High-speed digital output 2 configuration
Index	0x3151
Subindex	0x04
Data type	UNSIGNED8
Access type	RW
Default value	255: None
Value range	→ Table 6-135
PDO mapping	NO
Backup	YES

Value	Functionality	Description
255	None	No functionality assigned
254...25	reserved	–
24	Holding brake	Output functionality to drive a holding brake (for details see → “Holding brake parameters” on page 6-200)
23...0	reserved	–

Table 6-135 High-speed digital output 2 – Configuration

### 6.2.78 Holding brake parameters

Holding brakes are designed to provide protection against unintentional drifting at standstill. They are activated when no torque is applied to the motor. If the controller applies torque to the motor, the holding brake is deactivated (→chapter “2.2 Device Control” on page 2-16).

The functionality can be mapped to any digital output (→“Configuration of digital inputs” on page 6-195). Thereby, take the output current limit into account (for details see separate document →«Hardware Reference» of respective controller).

#### DESIGN CHARACTERISTICS OF HOLDING BRAKE

- The holding brake is not designed to brake loads. This is done by the controller.
- The holding brake or the motor may be damaged if the holding brake will activate before the motor has reached full standstill. Thus, it is of vital importance to configure the standstill conditions (→“Standstill window configuration” on page 6-191)!
- The holding brake function will only work properly if a main sensor is configured. Otherwise, there is no available information on the motor speed and, as a consequence thereof, there is no possibility to detect standstill →“Standstill window configuration” on page 6-191 and →“Control structure” on page 6-139).
- The parameters, their characteristics and configuration are optimized for the use of a permanent magnet brake. However, other brake types may be used whereby an appropriate interpretation of the parameters and the respective settings must be carefully considered.

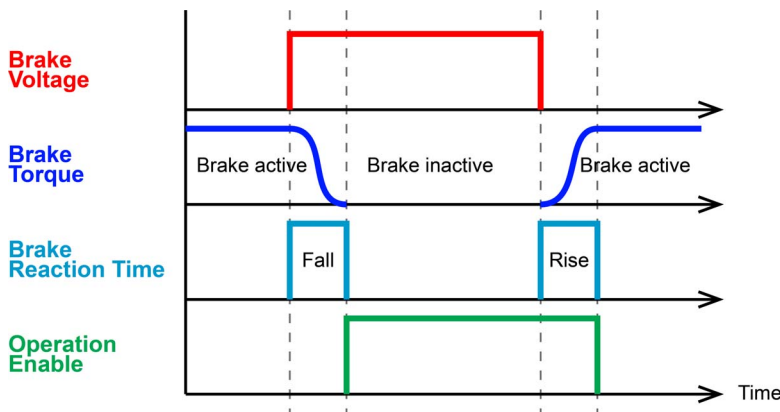

Figure 6-49 Holding brake activation timing (digital output polarity “High active”)

Name	Holding brake parameters
Index	0x3158
Object code	RECORD
Highest subindex supported	5: EPOS4 Disk 60/8 and EPOS4 Disk 60/12 3: Others

Continued on next page.

**6.2.78.1 Holding brake rise time**

Indicates the time required from power-off until reaching the holding brake's torque (→Figure 6-49). For permanent magnet brakes, the corresponding data sheet value is oftentimes called “reaction time coupling/closing”. The value is given in [ms].

Name	Holding brake rise time	
Index	0x3158	
Subindex	0x01	
Data type	UNSIGNED16	
Access type	RW	
Default value	10	
Value range	0	5'000
PDO mapping	NO	
Backup	YES	

**6.2.78.2 Holding brake fall time**

Indicates the time required from power-on until releasing the holding brake's torque (→Figure 6-49). For permanent magnet brakes, the corresponding data sheet value is oftentimes called “reaction time opening”. The value is given in [ms].

Name	Holding brake fall time	
Index	0x3158	
Subindex	0x02	
Data type	UNSIGNED16	
Access type	RW	
Default value	10	
Value range	0	5'000
PDO mapping	NO	
Backup	YES	

**6.2.78.3 Holding brake state**

Indicates the state of the holding brake.

Name	Holding brake state	
Index	0x3158	
Subindex	0x03	
Data type	UNSIGNED8	
Access type	RO	
Default value	–	
Value range	→Table 6-136	
PDO mapping	NO	
Backup	NO	

Value	State
0	Inactive
1	Active

Table 6-136 Holding brake states

#### 6.2.78.4 Holding brake maximal voltage

**The object is only available with...**

- «EPOS4 Disk 60/8»
- «EPOS4 Disk 60/12»

Indicates the maximal voltage of the holding brake. It is limited to the →Power supply voltage (0x2200; 0x01). The value is given in [0.1 V].

The object is only relevant if the holding brake functionality is configured via →High-speed digital output 2 configuration (0x3151; 0x04).

Related object: →“Power supply voltage” on page 6-134

Name	Holding brake maximal voltage	
Index	0x3158	
Subindex	0x04	
Data type	UNSIGNED16	
Access type	RW	
Default value	240	
Value range	0	600
PDO mapping	NO	
Backup	YES	

#### 6.2.78.5 Holding brake reduced voltage

**The object is only available with...**

- «EPOS4 Disk 60/8»
- «EPOS4 Disk 60/12»

Indicates the reduced voltage of the holding brake. It is limited to the →Holding brake maximal voltage (0x04) and is applied after elapsed fall time. The value is given in [0.1 V].

The object is only relevant if the holding brake functionality is configured via →High-speed digital output 2 configuration (0x3151; 0x04).

Name	Holding brake reduced voltage	
Index	0x3158	
Subindex	0x05	
Data type	UNSIGNED16	
Access type	RW	
Default value	240	
Value range	0	600
PDO mapping	NO	
Backup	YES	

## 6.2.79 Analog input properties

Name	Analog input properties
Index	0x3160
Object code	ARRAY
Highest subindex supported	2

### 6.2.79.1 Analog input *n* voltage

Represents the voltage measured at analog inputs. The value is given in [mV].

Names	Analog input 1 voltage Analog input 2 voltage
Index	0x3160
Subindex	0x01...0x02
Data type	INTEGER16
Access type	RO
Default value	–
Value range	–
PDO mapping	TXPDO
Backup	NO

## 6.2.80 Configuration of analog inputs

Configures the functionality that will be assigned to analog inputs.

Related object: →“Analog input properties” on page 6-203

Name	Configuration of analog inputs
Index	0x3161
Object code	ARRAY
Highest subindex supported	2

### 6.2.80.1 Analog input *n* configuration

Maps functions to analog inputs. Each function can only be mapped once, each analog input can only hold one function.

In CSV and an analog input configured as “Set value velocity” (9), the value of →Velocity offset (0x60B1) will automatically be set to “0” (zero). In CST and an analog input configured as “Set value current” (8), the value of →Torque offset (0x60B2) will automatically be set to “0” (zero).

Related objects: →“Modes of operation” on page 6-226 / →“Velocity offset” on page 6-243 / →“Torque offset” on page 6-243

Names	Analog input 1 configuration Analog input 2 configuration
Index	0x3161
Subindex	0x01...0x02
Data type	UNSIGNED8
Access type	RW
Default value	→Table 6-137
Value range	→Table 6-138
PDO mapping	NO
Backup	YES

Analog input	Default value
AnIn1	0: General purpose A
AnIn2	1: General purpose B

Table 6-137 Analog inputs – Default values

Value	Functionality	Description
255	None	No functionality assigned
254...10	reserved	–
9	Set value velocity	
8	Set value current	
7...2	reserved	–
1	General purpose B	Value can be read
0	General purpose A	Value can be read

Table 6-138 Analog inputs – Configuration



### 6.2.81 Analog input general purpose

Displays the actual value measured at the analog inputs. The value is only displayed if the analog input is configured as general purpose. The value is given in [mV].

Related object: →“Analog input properties” on page 6-203

Name	Analog input general purpose
Index	0x3162
Object code	ARRAY
Highest subindex supported	2

#### 6.2.81.1 Analog input general purpose n

Names	Analog input general purpose A Analog input general purpose B	
Index	0x3162	
Subindex	0x01...0x02	
Data type	INTEGER16	
Access type	RO	
Default value	–	
Value range	–	–
PDO mapping	TXPDO	
Backup	NO	

## 6.2.82 Analog input adjustment

Name	Analog input adjustment
Index	0x3163
Object code	RECORD
Highest subindex supported	4

### 6.2.82.1 Analog input *n* adjustment offset

Represents the adjustment offset voltage of an analog input. The value is given in [mV].

Names	Analog input 1 adjustment offset Analog input 2 adjustment offset
Index	0x3163
Subindex	0x01, 0x03
Data type	INTEGER16
Access type	RW
Default value	0
Value range	-1'000 1'000
PDO mapping	NO
Backup	YES

### 6.2.82.2 Analog input *n* adjustment gain factor

Represents the adjustment gain factor of an analog input. The value is given in [1/10000].

Names	Analog input 1 adjustment gain factor Analog input 2 adjustment gain factor
Index	0x3163
Subindex	0x02, 0x04
Data type	UNSIGNED16
Access type	RW
Default value	10'000
Value range	5'000 20'000
PDO mapping	NO
Backup	YES

### 6.2.83 Analog input current set value properties

A setpoint function for the analog input. It configures the current set value which is set by an analog input value. The functionality is supported in →“Cyclic Synchronous Torque Mode (CST)” on page 3-46.

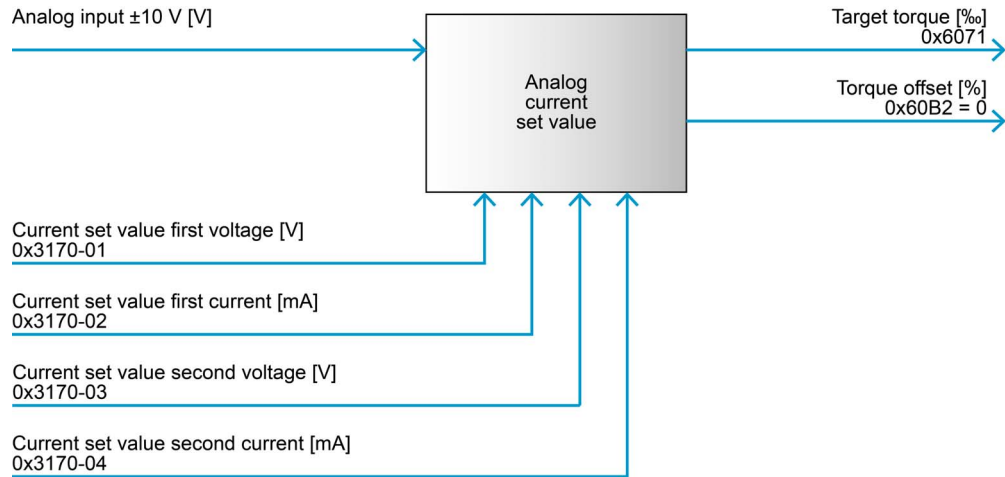

Figure 6-50 Analog input current set value properties – Setpoint function

Name	Analog input current set value properties
Index	0x3170
Object code	ARRAY
Highest subindex supported	4

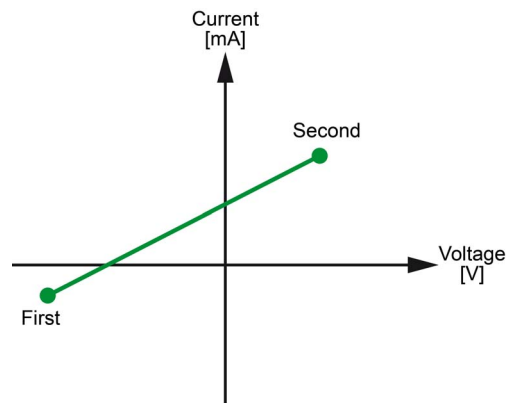

Figure 6-51 Analog input current set value properties – Set value

### 6.2.83.1 *Current set value first voltage*

Represents the set voltage for the first slope point. The value is given in [mV].

Name	Current set value first voltage	
Index	0x3170	
Subindex	0x01	
Data type	INTEGER32	
Access type	RW	
Default value	0	
Value range	-10'000	+10'000
PDO mapping	NO	
Backup	YES	

### 6.2.83.2 *Current set value first current*

Represents the output current for the first slope point. The value is given in [mA].

Name	Current set value first current	
Index	0x3170	
Subindex	0x02	
Data type	INTEGER32	
Access type	RW	
Default value	0	
Value range	-Max output current (→ Table 6-114)	+Max output current (→ Table 6-114)
PDO mapping	NO	
Backup	YES	

### 6.2.83.3 *Current set value second voltage*

Represents the set voltage for the second slope point. The value is given in [mV].

Name	Current set value second voltage	
Index	0x3170	
Subindex	0x03	
Data type	INTEGER32	
Access type	RW	
Default value	0	
Value range	-10'000	+10'000
PDO mapping	NO	
Backup	YES	

#### 6.2.83.4 *Current set value second current*

Represents the output current for the second slope point. The value is given in [mA].

Name	Current set value second current	
Index	0x3170	
Subindex	0x04	
Data type	INTEGER32	
Access type	RW	
Default value	0	
Value range	-Output current limit (→Table 6-114)	+Output current limit (→Table 6-114)
PDO mapping	NO	
Backup	YES	

### 6.2.84 Analog input velocity set value properties

A setpoint function for the analog input. It configures the velocity set value which is set by an analog input value. The input →Max acceleration is used to define the limitations for the target velocity. The functionality is supported in →“Cyclic Synchronous Velocity Mode (CSV)” on page 3-43.

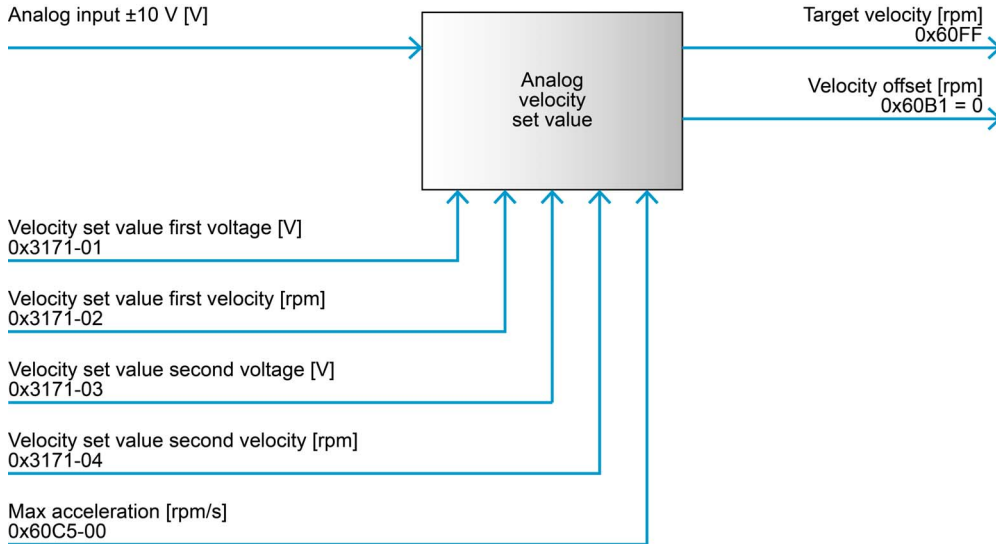

Figure 6-52 Analog input velocity set value properties – Setpoint function

Name	Analog input velocity set value properties
Index	0x3171
Object code	ARRAY
Highest subindex supported	4

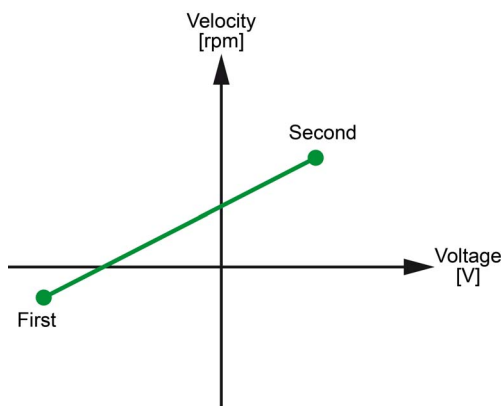

Figure 6-53 Analog input velocity set value properties – Set value

**6.2.84.1 Velocity set value first voltage**

Represents the set voltage for the first slope point. The value is given in [mV].

Name	Velocity set value first voltage	
Index	0x3171	
Subindex	0x01	
Data type	INTEGER32	
Access type	RW	
Default value	0	
Value range	-10'000	+10'000
PDO mapping	NO	
Backup	YES	

**6.2.84.2 Velocity set value first velocity**

Represents the set velocity for the first slope point. The value is given in [velocity units].

Name	Velocity set value first velocity	
Index	0x3171	
Subindex	0x02	
Data type	INTEGER32	
Access type	RW	
Default value	0	
Value range	-100'000 rpm	+100'000 rpm
PDO mapping	NO	
Backup	YES	

**6.2.84.3 Velocity set value second voltage**

Represents the set voltage for the second slope point. The value is given in [mV].

Name	Velocity set value second voltage	
Index	0x3171	
Subindex	0x03	
Data type	INTEGER32	
Access type	RW	
Default value	0	
Value range	-10'000	+10'000
PDO mapping	NO	
Backup	YES	

#### 6.2.84.4 Velocity set value second velocity

Represents the set velocity for the second slope point. The value is given in [velocity units].

Name	Velocity set value second velocity	
Index	0x3171	
Subindex	0x04	
Data type	INTEGER32	
Access type	RW	
Default value	0	
Value range	-100'000 rpm	+100'000 rpm
PDO mapping	NO	
Backup	YES	

### 6.2.85 Analog output properties

Name	Analog output properties
Index	0x3180
Object code	ARRAY
Highest subindex supported	1: EPOS4 Disk 60/8, EPOS4 Disk 60/12, and EPOS4 Micro 24/5 2: Others

#### 6.2.85.1 Analog output n voltage

Represents the voltage output at analog outputs. The value is given in [mV].

Names	Analog output 1 voltage Analog output 2 voltage [a]	
Index	0x3180	
Subindex	0x01, 0x02	
Data type	INTEGER16	
Access type	RO	
Default value	-	
Value range	-	-
PDO mapping	TXPDO	
Backup	NO	
[a] Not available with «EPOS4 Disk 60/8» / «EPOS4 Disk 60/12» / «EPOS4 Micro 24/5»		



## 6.2.86 Configuration of analog outputs

Configures the functionality that will be assigned to analog outputs.

Name	Configuration of analog outputs
Index	0x3181
Object code	ARRAY
Highest subindex supported	1: EPOS4 Disk 60/8, EPOS4 Disk 60/12, and EPOS4 Micro 24/5 2: Others

### 6.2.86.1 Analog output configuration

Names	Analog output 1 configuration Analog output 2 configuration [a]
Index	0x3181
Subindex	0x01, 0x02
Data type	UNSIGNED8
Access type	RW
Default value	→ Table 6-139
Value range	→ Table 6-140
PDO mapping	NO
Backup	YES
[a] Not available with «EPOS4 Disk 60/8» / «EPOS4 Disk 60/12» / «EPOS4 Micro 24/5»	

Analog output	Default value
AnlgOut1	0: General purpose A
AnlgOut2 [a]	1: General purpose B
[a] Not available with «EPOS4 Disk 60/8» / «EPOS4 Disk 60/12» / «EPOS4 Micro 24/5»	

Table 6-139 Analog outputs – Default values

Value	Functionality	Description
255	None	No functionality assigned
254...2	reserved	–
1	General purpose B	Value can be read/written by the host
0	General purpose A	Value can be read/written by the host

Table 6-140 Analog outputs – Configuration

## 6.2.87 Analog output general purpose

Used to set the actual voltage on the analog outputs. Write to this object has only an effect if the analog output is configured as general purpose. The value is given in [mV].

Related object: →“Analog output properties” on page 6-212

Name	Analog output general purpose
Index	0x3182
Object code	ARRAY
Highest subindex supported	1: EPOS4 Disk 60/8, EPOS4 Disk 60/12, and EPOS4 Micro 24/5 2: Others

### 6.2.87.1 Analog output general purpose n

Names	Analog output general purpose A Analog output general purpose B [a]	
Index	0x3182	
Subindex	0x01; 0x02	
Data type	INTEGER32	
Access type	RW	
Default value	0	
Value range	-4'000	4'000
PDO mapping	RXPDO	
Backup	YES	
[a] Not available with «EPOS4 Disk 60/8» / «EPOS4 Disk 60/12» / «EPOS4 Micro 24/5»		

## 6.2.88 Power limitation

Represents the model-based I2t power limitation parameters.

Name	Power limitation
Index	0x3200
Object code	RECORD
Highest subindex supported	2

### 6.2.88.1 I2t level motor

Provides the actual thermal state of the internal i2t motor protection feature. The number is given in percent but values higher than 100% are possible.

Name	I2t level motor
Index	0x3200
Subindex	0x01
Data type	UNSIGNED16
Access type	RO
Default value	–
Value range	–
PDO mapping	TXPDO
Backup	NO

### 6.2.88.2 I2t level power stage

Provides the actual thermal state of the internal I2t power stage protection feature. The number is given in percent but values higher than 100% are possible.

Name	I2t level power stage
Index	0x3200
Subindex	0x02
Data type	UNSIGNED16
Access type	RO
Default value	–
Value range	–
PDO mapping	TXPDO
Backup	NO

## 6.2.89 Thermal overload protection

Handles the thermal overload protection.

Name	Thermal overload protection
Index	0x3201
Object code	RECORD
Highest subindex supported	4

### 6.2.89.1 Temperature power stage

Displays the power stage temperature. The value is given in [0.1 C°].

Name	Temperature power stage
Index	0x3201
Subindex	0x01
Data type	INTEGER16
Access type	RO
Default value	–
Value range	–
PDO mapping	NO
Backup	NO

### 6.2.89.2 Maximal temperature power stage

Displays the maximal permitted power stage temperature. The value is given in [0.1 C°]. If the power stage temperature exceeds this value, the →Thermal overload error (0x4210) will be set.

Name	Maximal temperature power stage
Index	0x3201
Subindex	0x04
Data type	UNSIGNED16
Access type	RW
Default value	→Table 6-141
Value range	→Table 6-141
PDO mapping	NO
Backup	NO

Hardware	Default	Min	Max
EPOS4 Disk 60/8 CAN EPOS4 Disk 60/8 EtherCAT	950	0	950
EPOS4 Disk 60/12 CAN EPOS4 Disk 60/12 CAN SSC EPOS4 Disk 60/12 EtherCAT EPOS4 Disk 60/12 EtherCAT SSC	1'050	0	1'050
EPOS4 Micro 24/5 CAN	900	0	900
EPOS4 Micro 24/5 EtherCAT EPOS4 Compact 24/5 EtherCAT 3-axes	900	0	900

Continued on next page.

Hardware	Default	Min	Max
EPOS4 Module 24/1.5 EPOS4 Compact 24/1.5 CAN EPOS4 Compact 24/1.5 EtherCAT	1'000	0	1'000
EPOS4 Module 50/5 EPOS4 Compact 50/5 CAN EPOS4 Compact 50/5 EtherCAT	1'050	0	1'050
EPOS4 Module 50/8 EPOS4 Compact 50/8 CAN EPOS4 Compact 50/8 EtherCAT	1'000	0	1'000
EPOS4 Module 50/15 EPOS4 Compact 50/15 CAN EPOS4 Compact 50/15 EtherCAT	950	0	950
EPOS4 50/5	1'000	0	1'000
EPOS4 70/15	950	0	950

Table 6-141 Maximal temperature power stage

## 6.2.90 Functional safety

**The object is not available with...**

- «EPOS4 Disk 60/8»
- «EPOS4 Disk 60/12»
- «EPOS4 Micro 24/5»

Handles the functional safety.

Name	Functional safety
Index	0x3202
Object code	RECORD
Highest subindex supported	1

### 6.2.90.1 STO input states



**Find details here:**

For in-depth details on the STO functionality see separate document →«EPOS4 Application Notes».

Displays the STO input states.

Name	STO input states
Index	0x3202
Subindex	0x01
Data type	UNSIGNED8
Access type	RO
Default value	–
Value range	–
PDO mapping	NO
Backup	YES

Value	Description
0x00	No STO Input active
0x01	STO Input 1 active
0x02	STO Input 2 active
0x03	STO Input 1 and STO Input 2 active

Table 6-142 STO input states

## 6.2.91 Motor control

Handles the motor control.

Name	Motor control
Index	0x3203
Object code	RECORD
Highest subindex supported	1

### 6.2.91.1 PWM duty cycle actual value

Displays the duty cycle of a PWM signal that is applied to the motor. The value is given in thousandth part of the supply voltage.

Name	PWM duty cycle actual value
Index	0x3203
Subindex	0x01
Data type	UNSIGNED16
Access type	RO
Default value	–
Value range	–
PDO mapping	YES
Backup	NO

## 6.2.92 Abort connection option code

Specifies the action that will be performed when one of the errors labeled “a” (→“Device Errors” on page 7-273) will be detected. It contains all communication errors.

Some critical errors labeled “d” (→“Device Errors” on page 7-273) always lead to a Disable command even if the fault reaction was not configured to do so.

Related objects: →“Error register” on page 6-70 / →“Fault reaction option code” on page 6-225

Name	Abort connection option code
Index	0x6007
Subindex	0x00
Data type	INTEGER16
Access type	RW
Default value	3
Value range	2
PDO mapping	NO
Backup	YES

Value	Description
2	«Disable voltage» command
3	«Quick stop» command

Table 6-143 Abort connection option code

### 6.2.93 *Error code*

Provides the error code of the last error that occurred in the device. This value differs from the value in object →“Error register” on page 6-70. Yet, it is the value that will also appear in object →“Error history” on page 6-71.

Name	Error code
Index	0x603F
Subindex	0x00
Data type	UNSIGNED16
Access type	RO
Default value	–
Value range	–
PDO mapping	TXPDO
Backup	NO



## 6.2.94 Controlword

Comprises bits for the following items:

- →“Device Control Commands” on page 2-18 (bits 0...3, 7)
- Supervision of operating modes (bits 4...6, 8):
  - “Controlword (Profile Position Mode-specific Bits)” on page 3-25
  - “Controlword (Profile Velocity Mode-specific Bits)” on page 3-28
  - “Controlword (Homing Mode-specific Bits)” on page 3-31

For bit patterns of triggered commands →chapter “2.2.3 Device Control Commands” on page 2-18.

Related object: →“Statusword” on page 6-222

Name	Controlword		
Index	0x6040		
Subindex	0x00		
Data type	UNSIGNED16		
Access type	RW		
Default value	–		
Value range	–		–
PDO mapping	RXPDO, TXPDO		
Backup	NO		

Bit	Description	PPM	PVM	HMM	CSP	CSV	CST
15	Operating mode-specific	Endless movement	reserved	reserved	reserved	reserved	reserved
14...11	reserved						
10, 9	reserved						
8	Operating mode-specific	Halt	Halt	Halt			
7	Fault reset						
6	Operating mode-specific	Abs / rel	reserved	reserved			
5	Operating mode-specific	Change set immediately	reserved	reserved			
4	Operating mode-specific	New setpoint	reserved	Homing operation start			
3	Enable operation						
2	Quick stop						
1	Enable voltage						
0	Switched on						

Table 6-144 Controlword bits

## 6.2.95 Statusword

Comprises bits for the following items:

- “State of the Drive” on page 2-17 (bits 0...6)
- Operating state of the mode (bits 10, 12 and 13):
  - “Statusword (Profile Position Mode-specific Bits)” on page 3-26
  - “Statusword (Profile Velocity Mode-specific Bits)” on page 3-29
  - “Statusword (Homing Mode-specific Bits)” on page 3-32
  - “Statusword (Cyclic Synchronous Position Mode-specific Bits)” on page 3-42
  - “Statusword (Cyclic Synchronous Velocity Mode-specific Bits)” on page 3-45
  - “Statusword (Cyclic Synchronous Torque Mode-specific Bits)” on page 3-48
- Position referenced to home position (bit 15: will be set on homing attained and will be cleared on a position counter overflow or a position sensor error)
- Internal limit active (bit 11; signals a limitation based on an internal calculation)
  - I2t: Limitation according to the I2t method
  - Current: Limitation according to →Current demand value (0x30D0) and →Output current limit (0x3001; 0x02)
  - Max. velocity: Limitation according to →Velocity demand value (0x606B) and →Max profile velocity (0x607F)
  - Max. speed: Limitation according to →Velocity demand value (0x606B) and →Max system speed (0x3000; 0x06)
- Remote (bit 9: indicates NMT state is «Operational»)
- Warning (bit 7: indicates the presence of a warning condition)

Related object: →“Controlword” on page 6-221

Name	Statusword
Index	0x6041
Subindex	0x00
Data type	UNSIGNED16
Access type	RO
Default value	–
Value range	–
PDO mapping	TXPDO
Backup	NO

Bit	Description	PPM	PVM	HMM	CSP	CSV	CST
15	Position referenced to home position						
14	reserved (0)						
13	Operating mode-specific	Following error	Not used	Homing error	Following error		
12	Operating mode-specific	Setpoint acknowledge	Speed	Homing attained	Drive follows command value	Drive follows command value	Drive follows command value
11	Internal limit active	I2t, Current	I2t, Current Max velocity	I2t, Current	I2t, Current Max. speed	I2t, Current Max. speed	I2t, Current Max. speed
10	Operating mode-specific	Target reached	Target reached	Target reached	reserved	reserved	reserved
9	Remote						
8	reserved (0)						

Continued on next page.

Bit	Description	PPM	PVM	HMM	CSP	CSV	CST
7	Warning						
6	Switch on disabled						
5	Quick stop						
4	Voltage enabled (power stage on)						
3	Fault						
2	Operation enabled						
1	Switched on						
0	Ready to switch on						

Table 6-145 Statusword bits

### 6.2.96 Quick stop option code

Indicates the action that will be performed as «Quick stop» is executed.

Name	Quick stop option code		
Index	0x605A		
Subindex	0x00		
Data type	INTEGER16		
Access type	RW		
Default value	6		
Value range	6		6
PDO mapping	NO		
Backup	YES		

Value	Description
6	Decelerate with quick stop ramp and stay in «Quick stop active», enabled

Table 6-146 Quick stop option code

### 6.2.97 Shutdown option code

Indicates the action that will be performed during transition from state «Operation enabled» to states «Ready to switch on» or «Switch on disabled».

Name	Shutdown option code	
Index	0x605B	
Subindex	0x00	
Data type	INTEGER16	
Access type	RW	
Default value	0	
Value range	0	1
PDO mapping	NO	
Backup	YES	

Value	Description
1	Decelerate with slowdown ramp; disabling of the drive function
0	Disable drive function (switch-off the power stage)

Table 6-147 Shutdown option code

### 6.2.98 Disable operation option code

Indicates the action that will be performed during transition from state «Operation enabled» to state «Switched on».

Name	Disable operation option code	
Index	0x605C	
Subindex	0x00	
Data type	INTEGER16	
Access type	RW	
Default value	1	
Value range	0	1
PDO mapping	NO	
Backup	YES	

Value	Description
1	Decelerate with slowdown ramp; disabling of the drive function
0	Disable drive function (switch-off the power stage)

Table 6-148 Disable operation option code

### 6.2.99 Fault reaction option code

Specifies the action to be performed if one of the errors labeled “f” in the →“Device Errors” on page 7-273 will be detected. It contains most errors except communication errors (handled as to →“Abort connection option code” on page 6-219).

Some critical errors (labeled “d” (→“Device Errors” on page 7-273) always lead to a disable command even if the fault reaction was not configured to do so.

Related objects: →“Error register” on page 6-70 / →“Abort connection option code” on page 6-219

Name	Fault reaction option code	
Index	0x605E	
Subindex	0x00	
Data type	INTEGER16	
Access type	RW	
Default value	2	
Value range	0	2
PDO mapping	NO	
Backup	YES	

Value	Description
2	Decelerate with quick stop ramp; disabling of the drive function
1	Decelerate with slowdown ramp; disabling of the drive function
0	Disable drive function

Table 6-149 Fault reaction option code

### 6.2.100 Modes of operation

Switches the actually chosen operating mode. We recommend to use →Modes of operation display after changing the operation mode.

Related object: →“Modes of operation display” on page 6-226

Name	Modes of operation
Index	0x6060
Subindex	0x00
Data type	INTEGER8
Access type	RW
Default value	1
Value range	→Table 6-150
PDO mapping	RXPDO
Backup	YES

Operation mode	Description
1	→Profile Position Mode (PPM)
3	→Profile Velocity Mode (PVM)
6	→Homing Mode (HMM)
8	→Cyclic Synchronous Position Mode (CSP)
9	→Cyclic Synchronous Velocity Mode (CSV)
10	→Cyclic Synchronous Torque Mode (CST)

Table 6-150 Modes of operation

### 6.2.101 Modes of operation display

Displays the actual mode of operation. The meaning of the returned value corresponds to the code in →Table 6-150.

Related object: →“Modes of operation” on page 6-226

Name	Modes of operation display
Index	0x6061
Subindex	0x00
Data type	INTEGER8
Access type	RO
Default value	–
Value range	→Table 6-150
PDO mapping	TXPDO
Backup	NO

### 6.2.102 Position demand value

Used as input for the position controller. For profiled motions, the value is generated by the profile generator. The value is given in [position units] (→page 2-19).

Name	Position demand value	
Index	0x6062	
Subindex	0x00	
Data type	INTEGER32	
Access type	RO	
Default value	–	
Value range	–	–
PDO mapping	TXPDO	
Backup	NO	

### 6.2.103 Position actual value

Provides the actual position value of the axis, derived by the main sensor defined in →“Axis configuration” on page 6-138. The value is given in [position units] (→page 2-19).

- As soon as a homing procedure is successfully performed, the value is absolute and referenced which is indicated by the «Position referenced to home position» bit →“Statusword” on page 6-222
- If no main sensor is configured, the position actual value is always “0” (zero).

Related object: →“Additional position actual values” on page 6-256

Name	Position actual value	
Index	0x6064	
Subindex	0x00	
Data type	INTEGER32	
Access type	RO	
Default value	–	
Value range	–	–
PDO mapping	TXPDO	
Backup	NO	

### 6.2.104 Following error window

Represents the maximal permitted difference between →“Position actual value” on page 6-227 and →“Position demand value” on page 6-227. If exceeded, a following error will occur. If the value is set to 4'294'967'295, following error monitoring is switched off. The value is given in [position units] (→page 2-19).

Name	Following error window	
Index	0x6065	
Subindex	0x00	
Data type	UNSIGNED32	
Access type	RW	
Default value	2000	
Value range	0	2'147'483'647 (and 4'294'967'295 for disable)
PDO mapping	RXPDO	
Backup	YES	

### 6.2.105 *Following error time out*

Indicates the configured time for a following error condition. If exceeded, a following error will occur. The value is given in milliseconds [ms].

Name	Following error time out	
Index	0x6066	
Subindex	0x00	
Data type	UNSIGNED16	
Access type	RW	
Default value	0	
Value range	0	0
PDO mapping	RXPDO	
Backup	NO	



### 6.2.106 Position window

If the →Position demand value has reached the →Target position and the →Position actual value is within the position window for the configured →Position window time, the →Statusword's "Target reached" bit is set in PPM mode.

If the value of the position window is 4'294'967'295, the position window feature is switched off and the →Statusword's "Target reached" bit is set to "1" at the end of the trajectory, i.e. as soon as the internally calculated →Position demand value corresponds to the →Target position independent of the →Position actual value (which might be still different or moving due to friction or some →Following error actual value).

Related objects: →"Statusword" on page 6-222 / →"Target position" on page 6-232

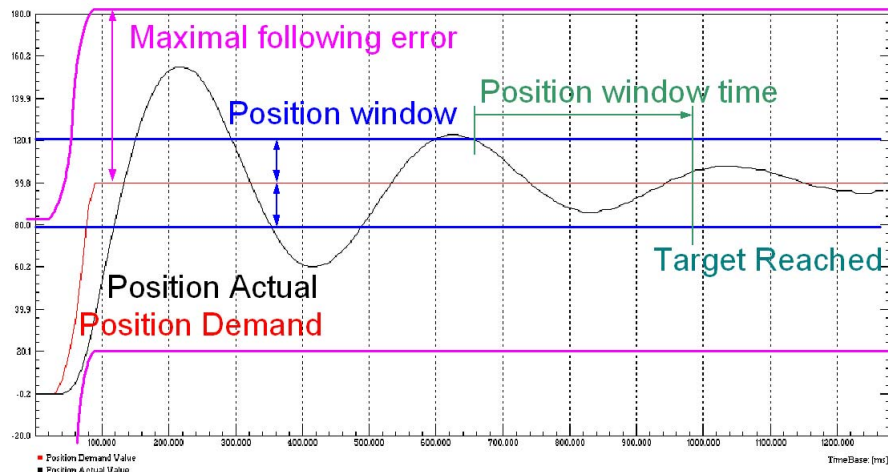

Figure 6-54 Position window

Name	Position window	
Index	0x6067	
Subindex	0x00	
Data type	UNSIGNED32	
Access type	RW	
Default value	4'294'967'295	
Value range	0	2'147'483'647 (and 4'294'967'295 for disable)
PDO mapping	RXPDO	
Backup	YES	

### 6.2.107 Position window time

Indicates the configured position window time for the target reached condition. If the actual position is within the →Position window during the set time, the corresponding bit 10 (target reached) in the →Statusword will be set to “1”. The value is given in [ms]

Related objects: →“Statusword” on page 6-222 / →“Position window” on page 6-229.

Name	Position window time
Index	0x6068
Subindex	0x00
Data type	UNSIGNED16
Access type	RW
Default value	0
Value range	–
PDO mapping	RXPDO
Backup	YES

### 6.2.108 Velocity demand value

Used as input for the position controller. For profiled moves, the value is generated by the profile generator. The value is given in [velocity units] (→page 2-19).

Name	Velocity demand value
Index	0x606B
Subindex	0x00
Data type	INTEGER32
Access type	RO
Default value	–
Value range	–
PDO mapping	TXPDO
Backup	NO

### 6.2.109 Velocity actual value

Provides the actual velocity value of the axis derived by the main sensor defined in →“Axis configuration” on page 6-138. If no main sensor is configured, the value is “0” (zero). The value is given in [velocity units] (→page 2-19).

Related objects: →“Velocity actual value averaged” on page 6-190 / →“Additional velocity actual values” on page 6-258

Name	Velocity actual value
Index	0x606C
Subindex	0x00
Data type	INTEGER32
Access type	RO
Default value	–
Value range	–
PDO mapping	TXPDO
Backup	NO

### 6.2.110 Target torque

Indicates the configured input value for the torque controller in Cyclic Synchronous Torque Mode. The value is given in per thousand of →“Motor rated torque” on page 6-231).

Related object: →“Motor rated torque” on page 6-231

Name	Target torque	
Index	0x6071	
Subindex	0x00	
Data type	INTEGER16	
Access type	RW	
Default value	0	
Value range	–	–
PDO mapping	RXPDO	
Backup	NO	

### 6.2.111 Motor rated torque

Holds the value to which all torque objects are related to. The value is defined as «Nominal current» multiplied by the «Torque constant». The value is given in [ $\mu\text{Nm}$ ].

Changing the value by write access is not permitted.

Related object: →“Motor data” on page 6-150

Name	Motor rated torque	
Index	0x6076	
Subindex	0x00	
Data type	UNSIGNED32	
Access type	RW	
Default value	0	
Value range	–	–
PDO mapping	NO	
Backup	NO	

### 6.2.112 Torque actual value

Provides the actual torque and corresponds to the motor’s instantaneous torque. The value is given in per thousand of →“Motor rated torque” on page 6-231).

Related object: →“Motor rated torque” on page 6-231

Name	Torque actual value	
Index	0x6077	
Subindex	0x00	
Data type	INTEGER16	
Access type	RO	
Default value	–	
Value range	–	–
PDO mapping	TXPDO	
Backup	NO	

### 6.2.113 Target position

Used as input for the profile generator during profiled moves. Represents the position that the drive is supposed to move using the motion control parameters (such as velocity, acceleration, and deceleration). For non-profiled moves, the target position is directly used as input for the position controller. The value is given in [position units] (→page 2-19).

The target position is not set until the command is given by the →“Controlword” on page 6-221. In this case, the target position will be interpreted as absolute or relative depending on the command set to the controlword. Otherwise, the target position is interpreted as absolute value.

Related objects: →“Profile velocity” on page 6-236 / →“Profile acceleration” on page 6-236

Name	Target position	
Index	0x607A	
Subindex	0x00	
Data type	INTEGER32	
Access type	RW	
Default value	0	
Value range	–	–
PDO mapping	RXPDO	
Backup	NO	

## 6.2.114 Position range limit

**The object is not yet implemented and is reserved for future use.**

For the time being, the value range of both objects is limited to the value of "0" (zero) meaning that the functionality of both objects →Min position range limit (0x607B; 0x01) and →Max position range limit (0x607B; 0x02) is disabled. A «Value range error» (abort code 0x0609; 0x30) will be reported in case of writing a value other than "0" (zero).

If you should require a way to implement a limitation of the motion range, you might wish to configure the →Software position limit (0x607D), instead.

Name	Position range limit
Index	0x607B
Object code	ARRAY
Highest subindex supported	2

### 6.2.114.1 Min position range limit

Defines the minimum position range limit by limiting the →Position demand value. Upon reaching or exceeding this limit, the input value automatically skips to the other end of the range. The value is given in [position units] (→page 2-19).

A value of "0" (zero) disables the minimum position range limit check.

Related object: →"Position demand value" on page 6-227

Name	Min position range limit	
Index	0x607B	
Subindex	0x01	
Data type	INTEGER32	
Access type	RW	
Default value	0	
Value range	0	0
PDO mapping	RXPDO	
Backup	NO	

### 6.2.114.2 Max position range limit

Defines the maximum position range limit by limiting the →Position demand value. Upon reaching or exceeding this limit, the input value automatically skips to the other end of the range. The value is given in [position units] (→page 2-19).

A value of "0" (zero) disables the maximum position range limit check.

Related object: →"Position demand value" on page 6-227

Name	Max position range limit	
Index	0x607B	
Subindex	0x02	
Data type	INTEGER32	
Access type	RW	
Default value	0	
Value range	0	0
PDO mapping	RXPDO	
Backup	YES	

### 6.2.115 Software position limit

Defines the min/max position values for the actual position value and the demand position value. An error is launched if the actual position value or the demand position value exceed their limits.

In PPM, the new target position is limited to the min/max position limit.

The software position limit supervision is inactive in Homing Mode (HMM).

Name	Software position limit
Index	0x607D
Object code	ARRAY
Highest subindex supported	2

#### 6.2.115.1 Min position limit

Defines the absolute negative position limit for the →Position demand value or the →Position actual value. The value is given in [position units] (→page 2-19).

If the desired or the actual position is lower than the negative position limit, a software position limit error will be launched.

If the value of Min position limit and Max position limit is "0" (zero), the position limit check is disabled.

Related objects: →"Position demand value" on page 6-227 / →"Position actual value" on page 6-227

Name	Min position limit	
Index	0x607D	
Subindex	0x01	
Data type	INTEGER32	
Access type	RW	
Default value	0	
Value range	-2'147'483'648	2'147'483'647
PDO mapping	RXPDO	
Backup	YES	

#### 6.2.115.2 Max position limit

Defines the absolute positive position limit for the →Position demand value or the →Position actual value. The value is given in [position units] (→page 2-19).

If the desired or the actual position is higher than the positive position limit, a software position limit error will be launched.

If the value of Min position limit and Max position limit is "0" (zero), position limit check is disabled.

Related objects: →"Position demand value" on page 6-227 / →"Position actual value" on page 6-227

Name	Max position limit	
Index	0x607D	
Subindex	0x02	
Data type	INTEGER32	
Access type	RW	
Default value	0	
Value range	-2'147'483'648	2'147'483'647
PDO mapping	RXPDO	
Backup	YES	

### 6.2.116 Max profile velocity

Used as velocity limit in a PPM or PVM move. The value is given in [velocity units] (→page 2-19).

Related objects: →“Profile velocity” on page 6-236 / →“Homing speeds” on page 6-239 / →“Max motor speed” on page 6-235 / →“Target velocity” on page 6-263 / →“Max gear input speed” on page 6-155 / →“Axis configuration” on page 6-138 / →“Max system speed” on page 6-149

Name	Max profile velocity	
Index	0x607F	
Subindex	0x00	
Data type	UNSIGNED32	
Access type	RW	
Default value	50'000	
Value range	1	→Max system speed
PDO mapping	RXPDO	
Backup	YES	

### 6.2.117 Max motor speed

Indicates the configured maximal allowed speed for the motor. It serves as protection of the motor. The value is given in [rpm] (→page 2-19).

For detailed motor specifications →maxon catalog.

Related objects: →“Motor type” on page 6-263 / →“Number of pole pairs” on page 6-152 / →“Max profile velocity” on page 6-235 / →“Target velocity” on page 6-263 / →“Max gear input speed” on page 6-155 / →“Max system speed” on page 6-149

Name	Max motor speed	
Index	0x6080	
Subindex	0x00	
Data type	UNSIGNED32	
Access type	RW	
Default value	50'000	
Value range	1	→Table 6-151
PDO mapping	RXPDO	
Backup	YES	

Motor type	Description	Maximum speed [rpm]
1	Brushed DC motor (maxon DC motor)	100'000
10	Brushless DC motor (maxon EC motor/BLDC motor), sinus commutated	50'000 / number of pole pairs
11	Brushless DC motor (maxon EC motor/BLDC motor), block commutated	100'000 / number of pole pairs

Table 6-151 Max motor speed

### 6.2.118 Profile velocity

Represents the velocity normally attained at the end of the acceleration ramp during a profiled move (PPM, PVM). The value is given in [velocity units] (→page 2-19).

Related object: →“Max profile velocity” on page 6-235

Name	Profile velocity
Index	0x6081
Subindex	0x00
Data type	UNSIGNED32
Access type	RW
Default value	1000
Value range	1 →Max profile velocity
PDO mapping	RXPDO
Backup	YES

### 6.2.119 Profile acceleration

Defines the acceleration value used during a profiled move. The value is given in [acceleration units] (→page 2-19).

Name	Profile acceleration
Index	0x6083
Subindex	0x00
Data type	UNSIGNED32
Access type	RW
Default value	10'000
Value range	1 →Max acceleration
PDO mapping	RXPDO
Backup	YES

### 6.2.120 Profile deceleration

Defines the deceleration value used during a profiled move. The value is given in [acceleration units] (→page 2-19).

Name	Profile deceleration
Index	0x6084
Subindex	0x00
Data type	UNSIGNED32
Access type	RW
Default value	10'000
Value range	1 →Max acceleration
PDO mapping	RXPDO
Backup	YES



### 6.2.121 Quick stop deceleration

Used with a «Quick stop» command to determine the deceleration of the quick stop profile. The value is given in [acceleration units] (→ page 2-19).

Related objects: → “Controlword” on page 6-221 / → “Fault reaction option code” on page 6-225 / → “Abort connection option code” on page 6-219

Name	Quick stop deceleration	
Index	0x6085	
Subindex	0x00	
Data type	UNSIGNED32	
Access type	RW	
Default value	10'000	
Value range	1	→ Max acceleration
PDO mapping	RXPDO	
Backup	YES	

### 6.2.122 Motion profile type

Selects the type of motion profile trajectory used in → “Profile Position Mode (PPM)” on page 3-23, → “Homing Mode (HMM)” on page 3-30, or → “Profile Velocity Mode (PVM)” on page 3-27.

Name	Motion profile type	
Index	0x6086	
Subindex	0x00	
Data type	INTEGER16	
Access type	RW	
Default value	0	
Value range	→ Table 6-152	–
PDO mapping	RXPDO	
Backup	YES	

Value	Description
0	linear ramp (trapezoidal profile)

Table 6-152 Motion profile types

### 6.2.123 Homing method

Used to select the desired homing method.

If the homing method is changed during an ongoing homing process, it will not come into effect before the next homing process is started.

Name	Homing method	
Index	0x6098	
Subindex	0x00	
Data type	INTEGER8	
Access type	RW	
Default value	7	
Value range	–	–
PDO mapping	RXPDO	
Backup	YES	

Value	Description
37	→Homing Method 37 (Actual Position)
34	→Homing Method 34 (Index Positive Speed) [a]
33	→Homing Method 33 (Index Negative Speed) [a]
27	→Homing Method 27 (Home Switch Negative Speed)
23	→Homing Method 23 (Home Switch Positive Speed)
18	→Homing Method 18 (Positive Limit Switch)
17	→Homing Method 17 (Negative Limit Switch)
11	→Homing Method 11 (Home Switch Negative Speed & Index) [a]
7	→Homing Method 7 (Home Switch Positive Speed & Index) [a]
2	→Homing Method 2 (Positive Limit Switch & Index) [a]
1	→Homing Method 1 (Negative Limit Switch & Index) [a]
-1	→Homing Method -1 (Current Threshold Positive Speed & Index) [a]
-2	→Homing Method -2 (Current Threshold Negative Speed & Index) [a]
-3	→Homing Method -3 (Current Threshold Positive Speed)
-4	→Homing Method -4 (Current Threshold Negative Speed)
[a] The index used for homing can be either a hardware index impulse (incremental encoder) or a virtual index (SSI sensor)	

Table 6-153 Homing methods

## 6.2.124 Homing speeds

Used to search a limit switch in a homing sequence. The value is given in [velocity units] (→page 2-19).

Related object: →“Max profile velocity” on page 6-235

Name	Homing speeds
Index	0x6099
Object code	ARRAY
Highest subindex supported	2

### 6.2.124.1 Speed for switch search

Name	Speed for switch search
Index	0x6099
Subindex	0x01
Data type	UNSIGNED32
Access type	RW
Default value	100
Value range	1 →Max profile velocity
PDO mapping	RXPDO
Backup	YES

### 6.2.124.2 Speed for zero search

Used to search the index in a homing sequence. The value is given in [velocity units] (→page 2-19).

Name	Speed for zero search
Index	0x6099
Subindex	0x02
Data type	UNSIGNED32
Access type	RW
Default value	10
Value range	1 →Max profile velocity
PDO mapping	RXPDO
Backup	YES

### 6.2.125 Homing acceleration

Used to define acceleration and deceleration ramps in the homing profile. The value is given in [acceleration units] (→page 2-19).

Related object: →“Max acceleration” on page 6-248

Name	Homing acceleration		
Index	0x609A		
Subindex	0x00		
Data type	UNSIGNED32		
Access type	RW		
Default value	1000		
Value range	1	→Max acceleration	
PDO mapping	RXPDO		
Backup	YES		

### 6.2.126 SI unit position

Defines the position units. Coding of the user-defined units and prefixes follows →chapter “2.3.1 SI Units” on page 2-19.

Write access is only permitted in device state «Power Disable».

Name	SI unit position
Index	0x60A8
Subindex	0x00
Data type	UNSIGNED32
Access type	RW
Default value	0x00B50000
Value range	→Table 6-155
PDO mapping	NO
Backup	YES

Bit 31...24	Bit 23...16	Bit 15...8	Bit 7...0
Prefix	Numerator	Denominator	reserved (0)

Table 6-154 SI units position – Bits

Value	Description	Symbol
0x00B50000	Increments	inc

Table 6-155 SI units position – Value range

### 6.2.127 SI unit velocity

Defines the velocity units. Coding of the user-defined units and prefixes follows → chapter “2.3.1 SI Units” on page 2-19.

Write access is only permitted in device state «Power Disable».

Name	SI unit velocity
Index	0x60A9
Subindex	0x00
Data type	UNSIGNED32
Access type	RW
Default value	0x00B44700
Value range	→ Table 6-157
PDO mapping	NO
Backup	YES

Bit 31...24	Bit 23...16	Bit 15...8	Bit 7...0
Prefix	Numerator	Denominator	reserved (0)

Table 6-156 SI units velocity – Bits

Value	Description	Symbol
0x00B44700	Revolutions/minute	rev/min (rpm)
0xFFB44700	0.1 revolutions/minute	deci rev/min (drpm)
0xFEB44700	0.01 revolutions/minute	centi rev/min (crpm)
0xFDB44700	0.001 revolutions/minute	milli rev/min (mrpm)
0xFCB44700	0.0001 revolutions/minute	$10^{-4}$ rev/min ( $10^{-4}$ rpm)
0xFBB44700	0.00001 revolutions/minute	$10^{-5}$ rev/min ( $10^{-5}$ rpm)
0xFAB44700	0.000001 revolutions/minute	micro rev/min ( $\mu$ rpm)

Table 6-157 SI units velocity – Value range

### 6.2.128 SI unit acceleration

Defines the acceleration units. Coding of the user-defined units and prefixes follows →chapter “2.3.1 SI Units” on page 2-19.

Write access is only permitted in device state «Power Disable».

Name	SI unit acceleration
Index	0x60AA
Subindex	0x00
Data type	UNSIGNED32
Access type	RW
Default value	0x00C00300
Value range	→Table 6-159
PDO mapping	NO
Backup	YES

Bit 31...24	Bit 23...16	Bit 15...8	Bit 7...0
Prefix	Numerator	Denominator	reserved (0)

Table 6-158 SI units acceleration – Bits

Value	Description	Symbol
0x00C00300	(Revolutions/minute)/second	rpm/s

Table 6-159 SI units acceleration – Value range

### 6.2.129 Position offset

Provides the offset of the position. The value is given in [position units].

- In CSP, the object contains the commanded additive position of the drive which is then added to the →Target position.

Related object: →“Target position” on page 6-232

Name	Position offset
Index	0x60B0
Subindex	0x00
Data type	INTEGER32
Access type	RW
Default value	0
Value range	–
PDO mapping	RXPDO
Backup	NO

### 6.2.130 Velocity offset

In CSV, the object provides the offset towards the →Target velocity. The value itself is absolute but, since it represents an additive velocity value, it also can be used to control the drive with relative values in respect to the →Target velocity. The value is given in [velocity units] (→page 2-19).

Name	Velocity offset
Index	0x60B1
Subindex	0x00
Data type	INTEGER32
Access type	RW
Default value	0
Value range	–
PDO mapping	RXPDO
Backup	NO

### 6.2.131 Torque offset

Provides the offset of the torque. The value is given in per thousand of →“Motor rated torque” on page 6-231.

- In CSP, the object contains the input value for torque feed forward.
- In CST, the object contains the commanded additive torque of the drive which is then added to the →Target torque.

Related object: →“Target torque” on page 6-231

Name	Torque offset
Index	0x60B2
Subindex	0x00
Data type	INTEGER16
Access type	RW
Default value	0
Value range	–
PDO mapping	RXPDO
Backup	NO

### 6.2.132 Touch probe function

Configures the touch probe function. Consider →“Digital Input Timing Behavior” on page 4-58 and take note that the touch probe function and Homing Mode cannot be used at the same time. After homing, all touch probe states and latched positions are cleared.

Related object: →“Configuration of digital inputs” on page 6-195

Name	Touch probe function
Index	0x60B8
Subindex	0x00
Data type	UNSIGNED16
Access type	RW
Default value	0
Value range	→Table 6-160
PDO mapping	RXPDO
Backup	NO

Bit	Value	Description
15...6	–	reserved
5 [a]	1	Enable sampling a negative edge touch probe 1
	0	Switch off sampling a negative edge touch probe 1
4 [a]	1	Enable sampling a positive edge touch probe 1
	0	Switch off sampling a positive edge touch probe 1
3; 2 [b]	11	reserved
	10	Touch probe source defined by object 0x60D0-01
	01	Trigger on main encoder index signal [c]
	00	Trigger on touch probe (input mapped to touch probe 1)
1	1	Continuous
	0	Trigger first event
0	1	Enable touch probe 1
	0	Switch off touch probe 1

[a] If main encoder index signal is selected, it is not possible to configure both edges at the same time.  
[b] Configuring bits 3 or 2 with either values 00 or 10 results in the same behavior.  
[c] The index used for homing can be either a hardware index impulse (incremental encoder) or a virtual index (SSI sensor).

Table 6-160 Touch probe function



### 6.2.133 Touch probe status

Provides the status of the touch probe. Status information of the touch probe shall first be evaluated by the control device to check whether the stored touch probe values (→Touch probe 1 positive edge and →Touch probe 1 negative edge) are valid.

Related objects: →“Touch probe 1 positive edge” on page 6-245 / →“Touch probe 1 negative edge” on page 6-246

Name	Touch probe status
Index	0x60B9
Subindex	0x00
Data type	UNSIGNED16
Access type	RO
Default value	0
Value range	→Table 6-161
PDO mapping	TXPDO
Backup	NO

Bit	Value	Description
15...3	–	reserved
2	1	Touch probe 1, negative edge position stored
	0	Touch probe 1, no negative edge position stored
1	1	Touch probe 1, positive edge position stored
	0	Touch probe 1, no positive edge position stored
0	1	Touch probe 1 enabled
	0	Touch probe 1 switched off

Table 6-161 Touch probe status

### 6.2.134 Touch probe 1 positive edge

Provides the position value of the touch probe 1 at positive edge detection. The object is only valid if the position is stored (→Touch probe status; bit 1). The value is given in [position units] (→“System Units” on page 2-19)

Related object: →“Touch probe status” on page 6-245

Name	Touch probe 1 positive edge
Index	0x60BA
Subindex	0x00
Data type	INTEGER32
Access type	RO
Default value	–
Value range	–
PDO mapping	TXPDO
Backup	NO

### 6.2.135 Touch probe 1 negative edge

Provides the position value of the touch probe 1 at negative edge detection. The object is only valid if the position is stored (→Touch probe status; bit 1). The value is given in [position units] (→“System Units” on page 2-19)

Related object: →“Touch probe status” on page 6-245

Name	Touch probe 1 negative edge	
Index	0x60BB	
Subindex	0x00	
Data type	INTEGER32	
Access type	RO	
Default value	–	
Value range	–	–
PDO mapping	TXPDO	
Backup	NO	

## 6.2.136 Interpolation time period

Name	Interpolation time period
Index	0x60C2
Object code	RECORD
Highest subindex supported	2

### 6.2.136.1 Interpolation time period value

Indicates the time between two PDOs. Values > "0" (zero) enable the demand value interpolation in CSP and CSV. It is of importance that the setpoint (→Target position, →Position offset, →Target velocity, →Velocity offset) is written cyclically with the interpolation time period.

The value is given in  $[s \cdot 10^{\text{interpolation time index}}]$ . An →Interpolation time index of value -3 indicates that the interpolation time period value is given in milliseconds.

The value "0" (zero) disables the demand value interpolation.



#### Best Practice

The «Interpolation time period value» must be configured to correspond with the master's synchronized PDO command cycle that updates the CSP set value, respectively the CSV set value.

If a value of "0" (zero) is configured, the device immediately takes the new set value and adapts the position (in case of CSP mode), respectively the velocity (in case of CSV mode) to it within the next control cycle (i.e. 0.4 ms). Afterwards it holds this set value until the next set value of the master is received. This results in an interrupted and noisy motion if the master just provides new set values at cycle rates of 1 ms, 2 ms, or even lower.

If the «Interpolation time period value» is configured properly based on the master's PDO cycle time, the device interpolates the new set value in between the period. This results in a smooth motion and less noisy control result.

Name	Interpolation time period value	
Index	0x60C2	
Subindex	0x01	
Data type	UNSIGNED8	
Access type	RW	
Default value	0	
Value range	0	100
PDO mapping	RXPDO	
Backup	YES	

### 6.2.136.2 Interpolation time index

Defines the unit of the →Interpolation time period value. The value –3 corresponds to the unit [ms].

Name	Interpolation time index	
Index	0x60C2	
Subindex	0x02	
Data type	INTEGER8	
Access type	RW	
Default value	–3	
Value range	–3	–3
PDO mapping	RXPDO	
Backup	YES	

### 6.2.137 Max acceleration

Used to limit the maximal allowed acceleration to prevent mechanical damage. It represents the limit of all other acceleration/deceleration objects of the axis. The value is given in [acceleration units] (→page 2-19). In cyclic modes (CSP, CSV, CST), the object is not taken into account.

Related objects: →“Profile acceleration” on page 6-236 / →“Profile deceleration” on page 6-236 / →“Quick stop deceleration” on page 6-237 / →“Homing acceleration” on page 6-240

Name	Max acceleration	
Index	0x60C5	
Subindex	0x00	
Data type	UNSIGNED32	
Access type	RW	
Default value	4'294'967'295	
Value range	1	4'294'967'295
PDO mapping	RXPDO	
Backup	YES	

## 6.2.138 Touch probe source

Defines the source of the touch probe functions.

Name	Touch probe source
Index	0x60D0
Object code	ARRAY
Highest subindex supported	1

### 6.2.138.1 Touch probe 1 source

Defines the source of the touch probe 1 functions.

Name	Touch probe 1 source
Index	0x60D0
Subindex	0x01
Data type	INTEGER16
Access type	RO
Default value	–
Value range	→ Table 6-162
PDO mapping	NO
Backup	NO

Value	Description
5	index impulse signal of main sensor [a]
4	Digital input 4
3	Digital input 3
2	Digital input 2
1	Digital input 1
0, -1	reserved
-2	High-speed digital input 2 [b]
-3	reserved
-4	High-speed digital input 4
[a] Only permitted when the main sensor has an index signal. Can be a hardware index impulse (incremental encoder) or a virtual index in case of an SSI sensor.	
[b] Not available with «EPOS4 Disk 60/8» / «EPOS4 Disk 60/12» / «EPOS4 Micro 24/5»	

Table 6-162 Touch probe 1 source

### 6.2.139 Touch probe 1 positive edge counter

Provides a continuous counter being incremented with each positive edge at touch probe 1. The counter is only valid if the sampling of the positive edge is enabled (→ Touch probe status; bit 0 and bit 4) and cleared when the touch probe is disabled.

Related object: → “Touch probe status” on page 6-245

Name	Touch probe 1 positive edge counter
Index	0x60D5
Subindex	0x00
Data type	UNSIGNED16
Access type	RO
Default value	–
Value range	→ Table 6-163
PDO mapping	TXPDO
Backup	NO

Probe mode	Value range
Single event	0...1
Continuous	0...65'535 (with overflow)

Table 6-163 Touch probe 1 positive edge counter

### 6.2.140 Touch probe 1 negative edge counter

Provides a continuous counter being incremented with each negative edge at touch probe 1. The counter is only valid if the sampling of the negative edge is enabled (→ Touch probe status; bit 0 and bit 4) and cleared when the touch probe is disabled.

Related object: → “Touch probe status” on page 6-245

Name	Touch probe 1 negative edge counter
Index	0x60D6
Subindex	0x00
Data type	UNSIGNED16
Access type	RO
Default value	–
Value range	→ Table 6-164
PDO mapping	TXPDO
Backup	NO

Probe mode	Value range
Single event	0...1
Continuous	0...65'535 (with overflow)

Table 6-164 Touch probe 1 negative edge counter

### 6.2.141 Supported homing methods

Provides the supported homing methods of the drive.

Related object: →“Homing method” on page 6-238

Name	Supported homing methods
Index	0x60E3
Object code	ARRAY
Highest subindex supported	15

#### 6.2.141.1 1st supported homing method

Provides the 1st supported homing method of the drive.

Name	1st supported homing method
Index	0x60E3
Subindex	0x01
Data type	INTEGER8
Access type	CONST
Default value	37
Value range	→Table 6-153
PDO mapping	NO
Backup	NO

#### 6.2.141.2 2nd supported homing method

Provides the 2nd supported homing method of the drive.

Name	2nd supported homing method
Index	0x60E3
Subindex	0x02
Data type	INTEGER8
Access type	CONST
Default value	34
Value range	→Table 6-153
PDO mapping	NO
Backup	NO

### 6.2.141.3 3rd supported homing method

Provides the 3rd supported homing method of the drive.

Name	3rd supported homing method
Index	0x60E3
Subindex	0x03
Data type	INTEGER8
Access type	CONST
Default value	33
Value range	→Table 6-153
PDO mapping	NO
Backup	NO

### 6.2.141.4 4th supported homing method

Provides the 4th supported homing method of the drive.

Name	4th supported homing method
Index	0x60E3
Subindex	0x04
Data type	INTEGER8
Access type	CONST
Default value	27
Value range	→Table 6-153
PDO mapping	NO
Backup	NO

### 6.2.141.5 5th supported homing method

Provides the 5th supported homing method of the drive.

Name	5th supported homing method
Index	0x60E3
Subindex	0x05
Data type	INTEGER8
Access type	CONST
Default value	23
Value range	→Table 6-153
PDO mapping	NO
Backup	NO



**6.2.141.6 6th supported homing method**

Provides the 6th supported homing method of the drive.

Name	6th supported homing method
Index	0x60E3
Subindex	0x06
Data type	INTEGER8
Access type	CONST
Default value	18
Value range	→Table 6-153
PDO mapping	NO
Backup	NO

**6.2.141.7 7th supported homing method**

Provides the 7th supported homing method of the drive.

Name	7th supported homing method
Index	0x60E3
Subindex	0x07
Data type	INTEGER8
Access type	CONST
Default value	17
Value range	→Table 6-153
PDO mapping	NO
Backup	NO

**6.2.141.8 8th supported homing method**

Provides the 8th supported homing method of the drive.

Name	8th supported homing method
Index	0x60E3
Subindex	0x08
Data type	INTEGER8
Access type	CONST
Default value	11
Value range	→Table 6-153
PDO mapping	NO
Backup	NO

**6.2.141.9 9th supported homing method**

Provides the 9th supported homing method of the drive.

Name	9th supported homing method
Index	0x60E3
Subindex	0x09
Data type	INTEGER8
Access type	CONST
Default value	7
Value range	→Table 6-153
PDO mapping	NO
Backup	NO

**6.2.141.10 10th supported homing method**

Provides the 10th supported homing method of the drive.

Name	10th supported homing method
Index	0x60E3
Subindex	0x0A
Data type	INTEGER8
Access type	CONST
Default value	2
Value range	→Table 6-153
PDO mapping	NO
Backup	NO

**6.2.141.11 11th supported homing method**

Provides the 11th supported homing method of the drive.

Name	11th supported homing method
Index	0x60E3
Subindex	0x0B
Data type	INTEGER8
Access type	CONST
Default value	1
Value range	→Table 6-153
PDO mapping	NO
Backup	NO

**6.2.141.12 12th supported homing method**

Provides the 12th supported homing method of the drive.

Name	12th supported homing method
Index	0x60E3
Subindex	0x0C
Data type	INTEGER8
Access type	CONST
Default value	-1
Value range	→Table 6-153
PDO mapping	NO
Backup	NO

**6.2.141.13 13th supported homing method**

Provides the 13th supported homing method of the drive.

Name	13th supported homing method
Index	0x60E3
Subindex	0x0D
Data type	INTEGER8
Access type	CONST
Default value	-2
Value range	→Table 6-153
PDO mapping	NO
Backup	NO

**6.2.141.14 14th supported homing method**

Provides the 14th supported homing method of the drive.

Name	14th supported homing method
Index	0x60E3
Subindex	0x0E
Data type	INTEGER8
Access type	CONST
Default value	-3
Value range	→Table 6-153
PDO mapping	NO
Backup	NO

### 6.2.141.15 15th supported homing method

Provides the 15th supported homing method of the drive.

Name	15th supported homing method
Index	0x60E3
Subindex	0x0F
Data type	INTEGER8
Access type	CONST
Default value	-4
Value range	→Table 6-153
PDO mapping	NO
Backup	NO

### 6.2.142 Additional position actual values

Provides the actual position values of the axis derived by the sensors defined in →“Axis configuration” on page 6-138. If no sensor is configured in the corresponding field, the position actual value is “0” (zero). The value is given in [position units] (→page 2-19).

Related object: →“Position actual value” on page 6-227

Name	Additional position actual values
Index	0x60E4
Object code	ARRAY
Highest subindex supported	3

#### 6.2.142.1 Position actual value sensor 1

Name	Position actual value sensor 1
Index	0x60E4
Subindex	0x01
Data type	INTEGER32
Access type	RO
Default value	–
Value range	–
PDO mapping	TXPDO
Backup	NO

**6.2.142.2 Position actual value sensor 2**

Name	Position actual value sensor 2	
Index	0x60E4	
Subindex	0x02	
Data type	INTEGER32	
Access type	RO	
Default value	–	
Value range	–	–
PDO mapping	TXPDO	
Backup	NO	

**6.2.142.3 Position actual value sensor 3**

Name	Position actual value sensor 3	
Index	0x60E4	
Subindex	0x03	
Data type	INTEGER32	
Access type	RO	
Default value	–	
Value range	–	–
PDO mapping	TXPDO	
Backup	NO	

### 6.2.143 Additional velocity actual values

Provides the actual velocity values of the axis derived by the sensors defined in →“Axis configuration” on page 6-138. If no sensor is configured in the corresponding field, the velocity actual value is “0” (zero). The value is given in [velocity units] (→page 2-19).

The averaged velocity values represent the corresponding velocity actual value filtered by 1<sup>st</sup> order digital low-pass filter with a cut-off frequency of 5 Hz.

Related objects: →“Velocity actual value” on page 6-230 / →“Velocity actual value averaged” on page 6-190

Name	Additional velocity actual values
Index	0x60E5
Object code	ARRAY
Highest subindex supported	11

#### 6.2.143.1 Velocity actual value sensor 1

Name	Velocity actual value sensor 1
Index	0x60E5
Subindex	0x01
Data type	INTEGER32
Access type	RO
Default value	–
Value range	–
PDO mapping	TXPDO
Backup	NO

#### 6.2.143.2 Velocity actual value sensor 2

Name	Velocity actual value sensor 2
Index	0x60E5
Subindex	0x02
Data type	INTEGER32
Access type	RO
Default value	–
Value range	–
PDO mapping	TXPDO
Backup	NO

**6.2.143.3 Velocity actual value sensor 3**

Name	Velocity actual value sensor 3	
Index	0x60E5	
Subindex	0x03	
Data type	INTEGER32	
Access type	RO	
Default value	–	
Value range	–	–
PDO mapping	TXPDO	
Backup	NO	

**6.2.143.4 Velocity actual value averaged sensor 1**

Name	Velocity actual value averaged sensor 1	
Index	0x60E5	
Subindex	0x09	
Data type	INTEGER32	
Access type	RO	
Default value	–	
Value range	–	–
PDO mapping	TXPDO	
Backup	NO	

**6.2.143.5 Velocity actual value averaged sensor 2**

Name	Velocity actual value averaged sensor 2	
Index	0x60E5	
Subindex	0x0A	
Data type	INTEGER32	
Access type	RO	
Default value	–	
Value range	–	–
PDO mapping	TXPDO	
Backup	NO	

**6.2.143.6 Velocity actual value averaged sensor 3**

Name	Velocity actual value averaged sensor 3	
Index	0x60E5	
Subindex	0x0B	
Data type	INTEGER32	
Access type	RO	
Default value	–	
Value range	–	–
PDO mapping	TXPDO	
Backup	NO	

### 6.2.144 *Following error actual value*

Represents the actual value of the following error. The value is given in [position units] (→page 2-19).

Name	Following error actual value	
Index	0x60F4	
Subindex	0x00	
Data type	INTEGER32	
Access type	RO	
Default value	–	
Value range	–	–
PDO mapping	TXPDO	
Backup	NO	



### 6.2.145 Digital inputs

Displays the state of the digital input functionalities (after polarity correction by →“Digital input properties” on page 6-193; Polarity). A bit is read as “1” if the signal at the corresponding pin is high.

Related objects: →“Digital input properties” on page 6-193 / →“Configuration of digital inputs” on page 6-195

Name	Digital inputs	
Index	0x60FD	
Subindex	0x00	
Data type	UNSIGNED32	
Access type	RO	
Default value	–	
Value range	–	–
PDO mapping	TXPDO	
Backup	NO	

Value	Functionality	Description
255	None	No functionality assigned
254...29	reserved	–
28	Quick stop	Stop movement and switch to «Quick stop active» state (→“Device Control” on page 2-16 for valid transitions)
27	Drive enable	Enable/disable the drive or clear errors in «Fault» state (→“Device Control” on page 2-16 for valid transitions)
26	Touch probe [a]	Samples actual position
25	Positive limit switch without errors	Used in homing mode with corresponding methods only, does not generate limit errors
24	Negative limit switch without errors	Used in homing mode with corresponding methods only, does not generate limit errors
23	General purpose H	State can be read
22	General purpose G	State can be read
21	General purpose F	State can be read
20	General purpose E	State can be read
19	General purpose D	State can be read
18	General purpose C	State can be read
17	General purpose B	State can be read
16	General purpose A	State can be read
15...3	reserved	–
2	Home switch	Used in some homing modes
1	Positive limit switch	Generates limit error except in homing mode with corresponding methods
0	Negative limit switch	Generates limit error except in homing mode with corresponding methods
[a] Not available with HsDigIn1 and HsDigIn3		

Table 6-165 Digital inputs

## 6.2.146 Digital outputs

Configures the state of the digital output functionalities (before polarity correction by →“Digital output properties” on page 6-197; Polarity). If a bit is set to “1” and the polarity bit is set to “0” (zero), the signal at the corresponding pin is high.

Related objects: →“Digital output properties” on page 6-197 / →“Configuration of digital outputs” on page 6-198

Name	Digital outputs
Index	0x60FE
Object code	ARRAY
Highest subindex supported	1

### 6.2.146.1 Physical outputs

Name	Physical outputs
Index	0x60FE
Subindex	0x01
Data type	UNSIGNED32
Access type	Bit 0...23: RW / Bit 24...31: RO
Default value	0
Value range	–
PDO mapping	RXPDO
Backup	NO

Bit	Functionality	Description
31...26	reserved	–
25	Ready/Fault	Active on device ready / inactive on device fault state
24	Holding brake	Output functionality to drive a holding brake (for details see →“Holding brake parameters” on page 6-200)
23...19	reserved	–
18	General purpose C	State can be read/written by the host
17	General purpose B	State can be read/written by the host
16	General purpose A	State can be read/written by the host
15...1	reserved	–
0	Set brake (GPIO)	–

Table 6-166 Digital outputs

### 6.2.147 Target velocity

In Profile Velocity Mode (PVM), the object indicates the configured target velocity and is used as input for the trajectory generator. The value is given in [velocity units] (→page 2-19).

Related objects: →“Max profile velocity” on page 6-235 / →“Max motor speed” on page 6-235 / →“Profile acceleration” on page 6-236 / →“Profile deceleration” on page 6-236

Name	Target velocity
Index	0x60FF
Subindex	0x00
Data type	INTEGER32
Access type	RW
Default value	0
Value range	–
PDO mapping	RXPDO
Backup	NO

### 6.2.148 Motor type

Defines the motor type of the axis.

Changes are only supported in device state «Power Disable».

Related objects: →“Axis configuration” on page 6-138 / →“Motor data” on page 6-150

Name	Motor type
Index	0x6402
Subindex	0x00
Data type	UNSIGNED16
Access type	RW
Default value	10
Value range	→Table 6-167
PDO mapping	NO
Backup	YES

Value	DS-402 Name	Description
1	Phase-modulated DC motor	Brushed DC motor (maxon DC motor)
10	Sinusoidal PM BL motor	Brushless DC motor BLDC sinus commutated (maxon EC motor)
11	Trapezoidal PM BL motor	Brushless DC motor BLDC block commutated (maxon EC motor)

Table 6-167 Motor types

### 6.2.149 Supported drive modes

Provides an overview of the implemented operating modes in the device. Supported are the following modes:

- →Profile Position Mode (PPM)
- →Profile Velocity Mode (PVM)
- →Homing Mode (HMM)
- →Cyclic Synchronous Position Mode (CSP)
- →Cyclic Synchronous Velocity Mode (CSV)
- →Cyclic Synchronous Torque Mode (CST)

Name	Supported drive modes	
Index	0x6502	
Subindex	0x00	
Data type	UNSIGNED32	
Access type	RO	
Default value	0x000003A5	
Value range	–	–
PDO mapping	TXPDO	
Backup	NO	

Bit		Description
31...11	0	reserved
10	0	Cyclic Synchronous Torque Mode With Commutation Angle
9	1	Cyclic Synchronous Torque Mode (CST)
8	1	Cyclic Synchronous Velocity Mode (CSV)
7	1	Cyclic Synchronous Position Mode (CSP)
6	0	Interpolated Position Mode (IPM)
5	1	Homing Mode (HMM)
4	0	reserved
3	0	Torque Mode
2	1	Profile Velocity Mode (PVM)
1	0	Velocity Mode
0	1	Profile Position Mode (PPM)

Table 6-168 Supported drive modes – Bits

### 6.2.150 Modular device profile

The object is only available if the active fieldbus is EtherCAT.

Contains the information to interpret the objects in function areas of the modules.

Name	Modular device profile
Index	0xF000
Object code	RECORD
Highest subindex supported	2

#### 6.2.150.1 Index distance

Name	Index distance
Index	0xF000
Subindex	0x01
Data type	UNSIGNED16
Access type	RO
Default value	–
Value range	0x0010 0x0010
PDO mapping	NO
Backup	NO

#### 6.2.150.2 Maximum number of modules

Name	Maximum number of modules
Index	0xF000
Subindex	0x02
Data type	UNSIGNED16
Access type	RO
Default value	–
Value range	1 1
PDO mapping	NO
Backup	NO

## 6.2.151 Configured module ident list

The object is only available if the active fieldbus is EtherCAT.

Contains the identification numbers of the configured modules.

The device supports only one module. If the number of configured modules is set to “0” (zero), no module is active.

Write access is only permitted in ESM state «Pre-Operational».

Name	Configured module ident list
Index	0xF030
Object code	ARRAY
Highest subindex supported	1

### 6.2.151.1 Nbr of configured modules

Name	Nbr of configured modules		
Index	0xF030		
Subindex	0x00		
Data type	UNSIGNED8		
Access type	RW		
Default value	0		
Value range	0		1
PDO mapping	NO		
Backup	NO		

### 6.2.151.2 Module 1

For details and their definitions on objects specified for the MDP modules see →chapter “6.3 Modular Device Profile Module” on page 6-268.

Name	Module 1
Index	0xF030
Subindex	0x01
Data type	UNSIGNED32
Access type	RW
Default value	–
Value range	→Table 6-170
PDO mapping	NO
Backup	NO

Bit 31...28 (Nibble)	Bit 27...24 (Nibble)	Bit 23...8 (Word)	Bit 7...0 (Byte)
(0x6) EPOS4	Op mode	Application number	Version

Table 6-169 Configured module identification – Bits

Continued on next page.

Value	Description (MDP Profile 742)
0x61xxxxxx	PPM module ident
0x63xxxxxx	PVM module ident
0x68xxxxxx	CSP module ident
0x69xxxxxx	CSV module ident
0x6Axxxxxx	CST module ident

Table 6-170 Configured module identification types

### 6.2.152 Detected module ident list

The object is only available if the active fieldbus is EtherCAT.

Contains the module identification during power-up or after executing the «Detect Modules Command».

Name	Detected module ident list
Index	0xF050
Object code	ARRAY
Highest subindex supported	1

#### 6.2.152.1 Nbr of detected modules

Name	Nbr of detected modules
Index	0xF050
Subindex	0x00
Data type	UNSIGNED8
Access type	RO
Default value	0
Value range	0 1
PDO mapping	NO
Backup	NO

#### 6.2.152.2 Module 1

Name	Module 1
Index	0xF050
Subindex	0x01
Data type	UNSIGNED32
Access type	RO
Default value	–
Value range	→ Table 6-170
PDO mapping	NO
Backup	NO

## 6.3 Modular Device Profile Module

In the EtherCAT Slave Information (ESI) file, the default PDO mapping for the different operation modes is defined as Modular Device Profile (MDP) module. The module can be used by the EtherCAT master to remap the PDO for the selected mode.

The module outputs are assigned to the Receive PDO1 mapping (1600-xx), the module inputs are assigned to the Transmit PDO1 mapping (1A00-xx).

Related objects: → “Modular device profile” on page 6-265 / → “Configured module ident list” on page 6-266 / → “Detected module ident list” on page 6-267

### 6.3.1 MDP Module PPM

Mapped object	Object (index-subindex)	Object name
1 <sup>st</sup>	0x6040-00	→Controlword
2 <sup>nd</sup>	0x607A-00	→Target position
3 <sup>rd</sup>	0x6083-00	→Profile acceleration
4 <sup>th</sup>	0x6084-00	→Profile deceleration
5 <sup>th</sup>	0x6081-00	→Profile velocity
6 <sup>th</sup>	0x6060-00	→Modes of operation
7 <sup>th</sup>	0x60FE-01	→Digital outputs

Table 6-171 MDP module PPM mapping – Default values for RxPDO

Mapped object	Object (index-subindex)	Object name
1 <sup>st</sup>	0x6041-00	→Statusword
2 <sup>nd</sup>	0x6064-00	→Position actual value
3 <sup>rd</sup>	0x606C-00	→Velocity actual value
4 <sup>th</sup>	0x60F4-00	→Following error actual value
5 <sup>th</sup>	0x6061-00	→Modes of operation display
6 <sup>th</sup>	0x60FD-00	→Digital inputs

Table 6-172 MDP module PPM mapping – Default values for TxPDO



## 6.3.2 MDP Module PVM

Mapped object	Object (index-subindex)	Object name
1 <sup>st</sup>	0x6040-00	→Controlword
2 <sup>nd</sup>	0x60FF-00	→Target velocity
3 <sup>rd</sup>	0x6083-00	→Profile acceleration
4 <sup>th</sup>	0x6084-00	→Profile deceleration
5 <sup>th</sup>	0x6060-00	→Modes of operation
6 <sup>th</sup>	0x60FE-01	→Digital outputs

Table 6-173 MDP module PVM mapping – Default values for RxPDO

Mapped object	Object (index-subindex)	Object name
1 <sup>st</sup>	0x6041-00	→Statusword
2 <sup>nd</sup>	0x6064-00	→Position actual value
3 <sup>rd</sup>	0x606C-00	→Velocity actual value
4 <sup>th</sup>	0x6061-00	→Modes of operation display
5 <sup>th</sup>	0x60FD-00	→Digital inputs

Table 6-174 MDP module PVM mapping – Default values for TxPDO

### 6.3.3 MDP Module CSP

Mapped object	Object (index-subindex)	Object name
1 <sup>st</sup>	0x6040-00	→Controlword
2 <sup>nd</sup>	0x607A-00	→Target position
3 <sup>rd</sup>	0x60B0-00	→Position offset
4 <sup>th</sup>	0x60B2-00	→Torque offset
5 <sup>th</sup>	0x6060-00	→Modes of operation
6 <sup>th</sup>	0x60FE-01	→Digital outputs

Table 6-175 MDP module CSP mapping – Default values for RxPDO

Mapped object	Object (index-subindex)	Object name
1 <sup>st</sup>	0x6041-00	→Statusword
2 <sup>nd</sup>	0x6064-00	→Position actual value
3 <sup>rd</sup>	0x606C-00	→Velocity actual value
4 <sup>th</sup>	0x6077-00	→Torque actual value
5 <sup>th</sup>	0x6061-00	→Modes of operation display
6 <sup>th</sup>	0x60FD-00	→Digital inputs

Table 6-176 MDP module CSP mapping – Default values for TxPDO

## 6.3.4 MDP Module CSV

Mapped object	Object (index-subindex)	Object name
1 <sup>st</sup>	0x6040-00	→Controlword
2 <sup>nd</sup>	0x60FF-00	→Target velocity
3 <sup>rd</sup>	0x60B1-00	→Velocity offset
4 <sup>th</sup>	0x6060-00	→Modes of operation
5 <sup>th</sup>	0x60FE-01	→Digital outputs

Table 6-177 MDP module CSV mapping – Default values for RxPDO

Mapped object	Object (index-subindex)	Object name
1 <sup>st</sup>	0x6041-00	→Statusword
2 <sup>nd</sup>	0x6064-00	→Position actual value
3 <sup>rd</sup>	0x606C-00	→Velocity actual value
4 <sup>th</sup>	0x6077-00	→Torque actual value
5 <sup>th</sup>	0x6061-00	→Modes of operation display
6 <sup>th</sup>	0x60FD-00	→Digital inputs

Table 6-178 MDP module CSV mapping – Default values for TxPDO

### 6.3.5 MDP Module CST

Mapped object	Object (index-subindex)	Object name
1 <sup>st</sup>	0x6040-00	→Controlword
2 <sup>nd</sup>	0x6071-00	→Target torque
3 <sup>rd</sup>	0x60B2-00	→Torque offset
4 <sup>th</sup>	0x6060-00	→Modes of operation
5 <sup>th</sup>	0x60FE-01	→Digital outputs

Table 6-179 MDP module CST mapping – Default values for RxPDO

Mapped object	Object (index-subindex)	Object name
1 <sup>st</sup>	0x6041-00	→Statusword
2 <sup>nd</sup>	0x6064-00	→Position actual value
3 <sup>rd</sup>	0x606C-00	→Velocity actual value
4 <sup>th</sup>	0x6077-00	→Torque actual value
5 <sup>th</sup>	0x6061-00	→Modes of operation display
6 <sup>th</sup>	0x60FD-00	→Digital inputs

Table 6-180 MDP module CST mapping – Default values for TxPDO

## 7 ERROR HANDLING

### 7.1 Emergency Message Frame

Upon detection of device-internal errors, the device will transmit emergency message frames over the CANopen network using →“COB-ID EMCY” on page 6-75. An emergency message frame will be transmitted only once per error event and consists of the error code and the actual state of the →“Error register” on page 6-70.

Byte	0	1	2	3	4	5	6	7
Description	Error code		Error register	Not used (always “0”)				

Table 7-181 Emergency message frame

### 7.2 Device Errors

The device can detect a variety of device errors. The reaction to an error depends on error type and option code. After execution of the fault reaction, the device changes to fault state and the drive will be disabled.

The →“Error history” on page 6-71 holds the error codes that occurred and will be signaled via an emergency message frames. The →“Error register” on page 6-70 holds all set error flags and provides a summary on possible errors.

For fault reaction codes, the following notations will be used:

- a: Use →“Abort connection option code” on page 6-219.
- f: Use →“Fault reaction option code” on page 6-225.
- d: A secure movement is no longer possible.
- w: No effect on device status (warning).

“Position Clear” points out that the position will be clearing upon executing the error reset.

Error code	Error register	Name	Fault reaction code	Position clear
0x0000	0000 0000b	No Error	–	
0x1000	0000 0001b	→Generic error	d	
0x1080 ... 0x1088	0000 0001b	→Generic initialization error	d	
0x1090	0000 0001b	→Firmware incompatibility error	d	
0x2310	0000 0010b	→Overcurrent error	d	
0x2320	0000 0010b	→Power stage protection error	d	
0x3210	0000 0100b	→Overvoltage error	d	
0x3220	0000 0100b	→Undervoltage error	d	
0x4210	0000 1000b	→Thermal overload error	d	
0x4380	0000 1000b	→Thermal motor overload error	d	
0x5113	0000 0100b	→Logic supply voltage too low error	d	
0x5280	0000 0001b	→Hardware defect error	d	
0x5281	0000 0001b	→Hardware incompatibility error	d	

Continued on next page.

Error code	Error register	Name	Fault reaction code	Position clear
0x5480 ... 0x5483	0000 0001b	→Hardware error	d	
0x6080	0000 0001b	→Sign of life error	d	
0x6081	0000 0001b	→Extension 1 watchdog error	a	
0x6180 ... 0x61F0	0000 0001b	→Internal software error	d	
0x6320	0000 0001b	→Software parameter error	f	
0x6380	0000 0001b	→Persistent parameter corrupt error	d	
0x7320	0010 0000b	→Position sensor error	d	
0x7380	0010 0000b	→Position sensor breach error	d	X
0x7381	0010 0000b	→Position sensor resolution error	d	X
0x7382	0010 0000b	→Position sensor index error	d	X
0x7388	0010 0000b	→Hall sensor error	d	X
0x7389	0010 0000b	→Hall sensor not found error	d	X
0x738A	0010 0000b	→Hall angle detection error	d	X
0x738C	0010 0000b	→SSI sensor error	d	
0x738D	0010 0000b	→SSI sensor frame error	d	
0x7390	0010 0000b	→Missing main sensor error	d	
0x7391	0010 0000b	→Missing commutation sensor error	d	
0x7392	0010 0000b	→Main sensor direction error	d	X
0x8110	0001 0000b	→CAN overrun error (object lost)	a	
0x8111	0001 0000b	→CAN overrun error	a	
0x8120	0001 0000b	→CAN passive mode error	a	
0x8130	0001 0000b	→CAN heartbeat error	a	
0x8150	0001 0000b	→CAN PDO COB-ID collision	a	
0x8180	0001 0000b	→EtherCAT communication error	a	
0x8181	0001 0000b	→EtherCAT initialization error	d	
0x8182	0001 0000b	→EtherCAT Rx queue overflow	a	
0x8183	0001 0000b	→EtherCAT communication error (internal)	a	
0x8184	0001 0000b	→EtherCAT communication cycle time error	a	
0x81FD	0001 0000b	→CAN bus turned off	a	
0x81FE	0001 0000b	→CAN Rx queue overflow	a	
0x81FF	0001 0000b	→CAN Tx queue overflow	a	
0x8210	0001 0000b	→CAN PDO length error	a	
0x8250	0001 0000b	→RPDO timeout	a	
0x8280	0001 0000b	→EtherCAT PDO communication error	a	
0x8281	0001 0000b	→EtherCAT SDO communication error	a	
0x8611	1000 0000b	→Following error	f	
0x8A80	1000 0000b	→Negative limit switch error	f	
0x8A81	1000 0000b	→Positive limit switch error	f	

Continued on next page.

Error code	Error register	Name	Fault reaction code	Position clear
0x8A82	1000 0000b	→ Software position limit error	f	
0x8A88	0000 0001b	→ STO error	d	
0xFF01	0000 0000b	→ System overloaded error	w	
0xFF02	0000 0001b	→ Watchdog error	d	X
0xFF0B	0000 0001b	→ System peak overloaded error	d	
0xFF10	0010 0000b	→ Controller gain error	f	
0xFF11	0010 0000b	→ Auto tuning identification error	d	
0xFF12	0010 0000b	→ Auto tuning current limit error	d	
0xFF13	0010 0000b	→ Auto tuning identification current error	d	
0xFF14	0010 0000b	→ Auto tuning data sampling error	d	
0xFF15	0010 0000b	→ Auto tuning sample mismatch error	d	
0xFF16	0010 0000b	→ Auto tuning parameter error	d	
0xFF17	0010 0000b	→ Auto tuning amplitude mismatch error	d	
0xFF19	0010 0000b	→ Auto tuning timeout error	d	
0xFF20	0010 0000b	→ Auto tuning standstill error	d	
0xFF21	0010 0000b	→ Auto tuning torque invalid error	d	
0xFF22	0010 0000b	→ Auto tuning max system speed error	d	
0xFF23	0010 0000b	→ Auto tuning motor connection error	d	
0xFF24	0010 0000b	→ Auto tuning sensor signal error	d	

Table 7-182 Device error codes

### 7.2.1 Generic error

Error code	0x1000
Error register	0000 0001b
Cause	Unspecific error occurred
Effect	Device disabled Red LED "ON" Error flag set in → Statusword
Error recovery	Reset fault with → Controlword

### 7.2.2 Generic initialization error

Error code	0x1080 through 0x1088
Error register	0000 0001b
Cause	Critical error occurred during boot-up
Effect	Device disabled Red LED "ON" Error flag set in → Statusword
Error recovery	Reset device. If the problem persists, contact your supplier.

### 7.2.3 Firmware incompatibility error

Error code	0x1090
Error register	0000 0001b
Cause	Incompatible extension firmware version detected
Effect	Device disabled Red LED "ON" Error flag set in → Statusword
Error recovery	First, try to resolve by resetting the device. If reset fails, update the EPOS4 firmware with the extension attached. If the problem persists, contact your supplier.

### 7.2.4 Overcurrent error

Error code	0x2310
Error register	0000 0010b
Cause	<ul style="list-style-type: none"> <li>• Short circuit in motor winding</li> <li>• Controller gains too high and/or deceleration too high</li> <li>• Damaged power stage</li> </ul>
Effect	Device disabled Red LED "ON" Error flag set in → Statusword
Error recovery	Reset fault with → Controlword

### 7.2.5 Power stage protection error

Error code	0x2320
Error register	0000 0010b
Cause	<ul style="list-style-type: none"> <li>• Short circuit of motor winding against ground</li> <li>• Short circuit of motor winding against operating voltage Vcc</li> <li>• Damaged power stage</li> <li>• Strong motor ripple (on top of a high peak current draw)</li> <li>• High deceleration or acceleration demands (which push the control to its limits)</li> <li>• Max. peak current configured which is close to the power stage current protection level</li> <li>• Poor current control parameter set</li> <li>• Sudden STO input interruption or loose contact</li> </ul>
Effect	Device disabled Red LED "ON" Error flag set in → Statusword
Error recovery	Reset fault with → Controlword



**7.2.6 Overvoltage error**

Error code	0x3210
Error register	0000 0100b
Cause	Power supply voltage too high
Effect	Device disabled Red LED "ON" Error flag set in → Statusword
Error recovery	In most cases this error occurs at deceleration where the motor works as a generator and the energy flows from motor to power supply (resulting in an increased voltage). Usually, a capacitor (for example 2200 µF) close to the device will solve the problem. If not, a shunt regulator will be necessary to dissipate brake energy. Reset fault with → Controlword (only possible if supply voltage is in valid range).

**7.2.7 Undervoltage error**

Error code	0x3220
Error register	0000 0100b
Cause	<ul style="list-style-type: none"> <li>• Supply voltage is too low for operation</li> <li>• Power supply cannot supply required acceleration current</li> </ul>
Effect	Device disabled Red LED "ON" Error flag set in → Statusword
Error recovery	Reset fault with → Controlword

**7.2.8 Thermal overload error**

Error code	0x4210
Error register	0000 1000b
Cause	Temperature at device's power stage too high
Effect	Device disabled Red LED "ON" Error flag set in → Statusword
Error recovery	Reset fault with → Controlword (only possible if temperature is in valid range)

**7.2.9 Thermal motor overload error**

Error code	0x4380
Error register	0000 1000b
Cause	Temperature at motor too high or sensor not connected
Effect	Device disabled Red LED "ON" Error flag set in → Statusword
Error recovery	Reset fault with → Controlword (only possible if temperature is in valid range)

### 7.2.10 Logic supply voltage too low error

Error code	0x5113
Error register	0000 0100b
Cause	Logic supply voltage is too low for operation
Effect	Device disabled Red LED "ON" Error flag set in → Statusword
Error recovery	Reset fault with → Controlword (only possible if supply voltage is in valid range)

### 7.2.11 Hardware defect error

Error code	0x5280
Error register	0000 0001b
Cause	Hardware problem detected
Effect	Device disabled Red LED "ON" Error flag set in → Statusword
Error recovery	Reset device. If the problem persists, contact your supplier.

### 7.2.12 Hardware incompatibility error

Error code	0x5281
Error register	0000 0001b
Cause	An incompatible hardware combination was detected
Effect	Device disabled Red LED "ON" Error flag set in → Statusword
Error recovery	Reset device. If the problem persists, contact your supplier.

### 7.2.13 Hardware error

Error code	0x5480 through 0x5483
Error register	0000 0001b
Cause	A hardware problem was detected
Effect	Device disabled Red LED "ON" Error flag set in → Statusword
Error recovery	Reset device. If the problem persists, contact your supplier.

**7.2.14 Sign of life error**

Error code	0x6080
Error register	0000 0001b
Cause	Problem with connection to extension 1: <ul style="list-style-type: none"> <li>• Overload situation</li> <li>• Extension hardware failure</li> </ul>
Effect	Device disabled Red LED "ON" Error flag set in →Statusword
Error recovery	Reset fault with →Controlword Check that extension 1 is firmly connected If problem reoccurs frequently: <ul style="list-style-type: none"> <li>• Update firmware</li> <li>• Contact your supplier</li> </ul>

**7.2.15 Extension 1 watchdog error**

Error code	0x6081
Error register	0000 0001b
Cause	Connection loss to extension 1: <ul style="list-style-type: none"> <li>• Overload situation</li> <li>• Extension hardware failure</li> </ul>
Effect	Device disabled Red LED "ON" Error flag set in →Statusword
Error recovery	Reset fault with →Controlword Check that extension 1 is firmly connected If problem reoccurs frequently: <ul style="list-style-type: none"> <li>• Update firmware</li> <li>• Contact your supplier</li> </ul>

**7.2.16 Internal software error**

Error code	0x6180 through 0x61F0
Error register	0010 0000b
Cause	An internal software error occurred
Effect	Device disabled Red LED "ON" Error flag set in →Statusword
Error recovery	Reset fault with →Controlword

**7.2.17 Software parameter error**

Error code	0x6320
Error register	0000 0001b
Cause	Corrupt parameter detected: The constant velocity phase is too long due to high →Target position and low →Profile velocity
Effect	Fault reaction defined in →Fault reaction option code
Error recovery	Reset fault with →Controlword

**7.2.18 Persistent parameter corrupt error**

Error code	0x6380
Error register	0000 0001b
Cause	Persistent parameters are corrupt or inconsistent (wrong CRC)
Effect	Default parameters are set Device disabled Red LED "ON" Error flag set in → Statusword
Error recovery	Reset fault with → Controlword Set or load device parameters again

**7.2.19 Position sensor error**

Error code	0x7320
Error register	0010 0000b
Cause	Detected position of position sensor is no longer valid due to... <ul style="list-style-type: none"><li>• changed/wrong position sensor parameters</li><li>• other errors that influence the absolute position detection (such as Hall Sensor Error, Position Sensor Index Error, etc.)</li></ul>
Effect	Device disabled Red LED "ON" Error flag set in → Statusword
Error recovery	Reset fault with → Controlword

**7.2.20 Position sensor breach error**

Error code	0x7380
Error register	0010 0000b
Cause	Position sensor supervision has detected a bad working condition due to... <ul style="list-style-type: none"><li>• wrong/broken wiring of encoder</li><li>• defective encoder</li><li>• regulation parameter are not well tuned (→ Current control parameter set)</li></ul>
Effect	Device disabled Red LED "ON" Error flag set in → Statusword
Error recovery	Reset fault with → Controlword

**7.2.21 Position sensor resolution error**

Error code	0x7381
Error register	0010 0000b
Cause	<ul style="list-style-type: none"><li>• Encoder pulses counted between the first two index pulses do not fit the resolution</li><li>• Setting of encoder resolution is wrong</li></ul>
Effect	Device disabled Red LED "ON" Error flag set in → Statusword
Error recovery	Reset fault with → Controlword

**7.2.22 Position sensor index error**

Error code	0x7382
Error register	0010 0000b
Cause	Encoder index signal was not found within two turns at start-up due to... <ul style="list-style-type: none"> <li>• incorrect wiring of encoder cables</li> <li>• encoder without or with defective index channel</li> <li>• wrong sensor type</li> <li>• setting for encoder resolution too low</li> </ul>
Effect	Device disabled Red LED "ON" Error flag set in → Statusword
Error recovery	Reset fault with → Controlword

**7.2.23 Hall sensor error**

Error code	0x7388
Error register	0010 0000b
Cause	Motor Hall sensors report an impossible signal combination due to... <ul style="list-style-type: none"> <li>• incorrect wiring of Hall sensors</li> <li>• incorrect wiring of Hall sensor supply voltage</li> <li>• damaged Hall sensors</li> <li>• big Hall sensor signal noise</li> </ul>
Effect	Device disabled Red LED "ON" Error flag set in → Statusword
Error recovery	Reset fault with → Controlword

**7.2.24 Hall sensor not found error**

Error code	0x7389
Error register	0010 0000b
Cause	No Hall sensor 3 edge found within first motor turn due to... <ul style="list-style-type: none"> <li>• wrong wiring of Hall sensors</li> <li>• defective Hall sensors</li> <li>• setting for encoder resolution too low</li> </ul>
Effect	Device disabled Red LED "ON" Error flag set in → Statusword
Error recovery	Reset fault with → Controlword

### 7.2.25 Hall angle detection error

Error code	0x738A
Error register	0010 0000b
Cause	Angle difference measured between encoder and Hall sensors is too high due to... <ul style="list-style-type: none"> <li>• wrong wiring of Hall sensors</li> <li>• defective Hall sensors</li> <li>• wrong wiring of encoder</li> <li>• defective encoder</li> <li>• wrong setting of encoder resolution or pole pairs</li> </ul>
Effect	Device disabled Red LED "ON" Error flag set in → Statusword
Error recovery	Reset fault with → Controlword

### 7.2.26 SSI sensor error

Error code	0x738C
Error register	0010 0000b
Cause	SSI sensor driver could not sample position data
Effect	Device disabled Red LED "ON" Error flag set in → Statusword
Error recovery	Reset fault with → Controlword

### 7.2.27 SSI sensor frame error

Error code	0x738D
Error register	0010 0000b
Cause	Invalid SSI sensor data frame. Start and/or stop bits have invalid state: <ul style="list-style-type: none"> <li>• wrong wiring of SSI sensor</li> <li>• defective SSI sensor</li> <li>• wrong setting of encoder data bits</li> </ul>
Effect	Device disabled Red LED "ON" Error flag set in → Statusword
Error recovery	Reset fault with → Controlword

### 7.2.28 Missing main sensor error

Error code	0x7390
Error register	0010 0000b
Cause	No main sensor available. Adapt settings in → Axis configuration.
Effect	Device disabled Red LED "ON" Error flag set in → Statusword
Error recovery	Reset fault with → Controlword

**7.2.29 Missing commutation sensor error**

Error code	0x7391
Error register	0010 0000b
Cause	No commutation sensor available. Adapt settings in →Axis configuration.
Effect	Device disabled Red LED "ON" Error flag set in →Statusword
Error recovery	Reset fault with →Controlword

**7.2.30 Main sensor direction error**

Error code	0x7392
Error register	0010 0000b
Cause	Position sensor supervision has detected a turn-away of the motor in the opposite direction due to... <ul style="list-style-type: none"> <li>• wrong setting of sensor polarity</li> <li>• wrong position sensor wiring</li> <li>• wrong motor wiring</li> </ul>
Effect	Device disabled Red LED "ON" Error flag set in →Statusword
Error recovery	Reset fault with →Controlword

**7.2.31 CAN overrun error (object lost)**

Error code	0x8110
Error register	0001 0000b
Cause	One of the CAN mail boxes experienced an overflow caused by too high communication rate
Effect	Fault reaction defined in →Abort connection option code
Error recovery	Reset fault with →Controlword

**7.2.32 CAN overrun error**

Error code	0x8111
Error register	0001 0000b
Cause	Execution of CAN communication had an overrun caused by too high communication rate
Effect	Fault reaction defined in →Abort connection option code
Error recovery	Reset fault with →Controlword

### 7.2.33 CAN passive mode error

Error code	0x8120
Error register	0001 0000b
Cause	Device changed to CAN passive mode due to... <ul style="list-style-type: none"> <li>• CAN bit rate of one CAN node in network wrong</li> <li>• CAN network not connected</li> <li>• hardware wiring of CAN bus not correct</li> </ul>
Effect	Fault reaction defined in →Abort connection option code
Error recovery	Send NMT command reset communication, then reset fault with →Controlword

### 7.2.34 CAN heartbeat error

Error code	0x8130
Error register	0001 0000b
Cause	CANopen Heartbeat Consumer Procedure or Life Guarding have detected a timeout. Probably, the procedure has failed due to wrong configuration. Heartbeat Consumers will be disabled if →Consumer heartbeat time = 0.
Effect	Fault reaction defined in →Abort connection option code State transition defined in →Communication error
Error recovery	Send NMT command reset communication, then reset fault with →Controlword

### 7.2.35 CAN PDO COB-ID collision

Error code	0x8150
Error register	0001 0000b
Cause	Possibly, another CAN node has configured the same transmit PDO COB-ID. Device has received a bad transmit PDO request (valid COB-ID without RTR bit set).
Effect	Fault reaction defined in →Abort connection option code
Error recovery	Reset fault with →Controlword

### 7.2.36 EtherCAT communication error

Error code	0x8180
Error register	0001 0000b
Cause	EtherCAT communication error during operation enable (link lost)
Effect	Fault reaction defined in →Abort connection option code
Error recovery	Reset fault with →Controlword



**7.2.37 EtherCAT initialization error**

Error code	0x8181
Error register	0001 0000b
Cause	Initialization of the Ethernet module has failed
Effect	Device disabled Red LED "ON" Error flag set in → Statusword
Error recovery	Reset device. If the problem persists, perform firmware update or contact your supplier.

**7.2.38 EtherCAT Rx queue overflow**

Error code	0x8182
Error register	0001 0000b
Cause	The EtherCAT receive queue had an overrun caused by too high communication rate
Effect	Fault reaction defined in → Abort connection option code
Error recovery	Reset fault with → Controlword

**7.2.39 EtherCAT communication error (internal)**

Error code	0x8183
Error register	0001 0000b
Cause	Internal communication of the EtherCAT module has failed
Effect	Fault reaction defined in Abort connection option code
Error recovery	Reset fault with → Controlword

**7.2.40 EtherCAT communication cycle time error**

Error code	0x8184
Error register	0001 0000b
Cause	EtherCAT communication error because of invalid cycle time
Effect	Fault reaction defined in Abort connection option code
Error recovery	Reset fault with → Controlword

**7.2.41 CAN bus turned off**

Error code	0x81FD
Error register	0001 0000b
Cause	CAN controller has entered CAN bus off state
Effect	Fault reaction defined in → Abort connection option code
Error recovery	Reset fault with → Controlword

**7.2.42 CAN Rx queue overflow**

Error code	0x81FE
Error register	0001 0000b
Cause	One of the CAN receive queues had an overrun caused by too high communication rate
Effect	Fault reaction defined in →Abort connection option code
Error recovery	Reset fault with →Controlword

**7.2.43 CAN Tx queue overflow**

Error code	0x81FF
Error register	0001 0000b
Cause	One of the CAN transmit queues had an overrun caused by too high communication rate due to... <ul style="list-style-type: none"><li>• load on CAN bus too high</li><li>• event-triggered PDOs defined with too small inhibit time</li><li>• PDO communication configured too high (synchronous) for actual cycle time</li><li>• CAN bus inactive but heartbeat producer enabled (→Producer heartbeat time)</li></ul>
Effect	Fault reaction defined in →Abort connection option code
Error recovery	Reset fault with →Controlword

**7.2.44 CAN PDO length error**

Error code	0x8210
Error register	0001 0000b
Cause	Received PDO was not processed due to length error (too short)
Effect	Fault reaction defined in →Abort connection option code
Error recovery	Reset fault with →Controlword

**7.2.45 RPDO timeout**

Error code	0x8250
Error register	0001 0000b
Cause	<ul style="list-style-type: none"><li>• Interpolation aborted in cyclic mode due to no PDO received after elapsed interpolation time period</li><li>• The error also occurs if the master aborts communication, e.g. due to timing violations of the synchronous PDO transfer</li></ul>
Effect	Fault reaction defined in →Abort connection option code
Error recovery	Reset fault with →Controlword

**7.2.46 EtherCAT PDO communication error**

Error code	0x8280
Error register	0001 0000b
Cause	EtherCAT module detected an error at Process Data (PDO) communication
Effect	Fault reaction defined in →Abort connection option code
Error recovery	Reset fault with →Controlword

**7.2.47 EtherCAT SDO communication error**

Error code	0x8281
Error register	0001 0000b
Cause	EtherCAT module detected an error at Service Data (SDO) communication
Effect	Fault reaction defined in →Abort connection option code
Error recovery	Reset fault with →Controlword

**7.2.48 Following error**

Error code	0x8611
Error register	1000 0000b
Cause	Difference between →Position demand value and →Position actual value higher than →Following error window
Effect	Fault reaction defined in →Fault reaction option code
Error recovery	Reset fault with →Controlword

**7.2.49 Negative limit switch error**

Error code	0x8A80
Error register	1000 0000b
Cause	<ul style="list-style-type: none"> <li>Negative limit switch was/is active</li> <li>Wrong configuration of limit switch function in →Digital inputs</li> </ul>
Effect	Fault reaction defined in →Fault reaction option code
Error recovery	Reset fault with →Controlword

**7.2.50 Positive limit switch error**

Error code	0x8A81
Error register	1000 0000b
Cause	<ul style="list-style-type: none"> <li>Positive limit switch was/is active</li> <li>Wrong configuration of limit switch function in →Digital inputs</li> </ul>
Effect	Fault reaction defined in →Fault reaction option code
Error recovery	Reset fault with →Controlword

**7.2.51 Software position limit error**

Error code	0x8A82
Error register	1000 0000b
Cause	Movement commanded or actual position runs out of software position limit
Effect	Fault reaction defined in →Fault reaction option code
Error recovery	Reset fault with →Controlword

#### 7.2.52 STO error

Error code	0x8A88
Error register	0000 0001b
Cause	Error when STO is not active. STO functionality was triggered while power stage was enabled.
Effect	Device disabled Red LED "ON" Error flag set in → Statusword
Error recovery	Reset fault with → Controlword

#### 7.2.53 System overloaded error

Error code	0xFF01
Error register	0000 0000b
Cause	Device has not enough free resources to process new commands
Effect	Warning bit set in → Statusword
Error recovery	Reset fault by clearing → Diagnosis History / → Error history

#### 7.2.54 Watchdog error

Error code	0xFF02
Error register	0000 0001b
Cause	Cyclic monitoring has detected an invalid device status
Effect	Device disabled Red LED "ON" Error flag set in → Statusword
Error recovery	Reset fault with → Controlword

#### 7.2.55 System peak overloaded error

Error code	0xFF0B
Error register	0000 0001b
Cause	The device has not enough free resources to provide proper regulation
Effect	Device disabled Red LED "ON" Error flag set in → Statusword
Error recovery	Reset fault with → Controlword

#### 7.2.56 Controller gain error

Error code	0xFF10
Error register	0010 0000b
Cause	Control function not possible due to bad controller gains
Effect	Device disabled Red LED "ON" Error flag set in → Statusword Fault reaction defined in → Fault reaction option code
Error recovery	Reset fault with → Controlword

**7.2.57 Auto tuning identification error**

Error code	0xFF11
Error register	0010 0000b
Cause	An error occurred during auto tuning identification
Effect	Device disabled Red LED "ON" Error flag set in → Statusword
Error recovery	Reset fault with → Controlword

**7.2.58 Auto tuning current limit error**

Error code	0xFF12
Error register	0010 0000b
Cause	Current limit occurred during auto tuning identification
Effect	Device disabled Red LED "ON" Error flag set in → Statusword
Error recovery	Reset fault with → Controlword

**7.2.59 Auto tuning identification current error**

Error code	0xFF13
Error register	0010 0000b
Cause	Identification current could not be reached during auto tuning identification
Effect	Device disabled Red LED "ON" Error flag set in → Statusword
Error recovery	Reset fault with → Controlword

**7.2.60 Auto tuning data sampling error**

Error code	0xFF14
Error register	0010 0000b
Cause	Data sampling initialization has failed
Effect	Device disabled Red LED "ON" Error flag set in → Statusword
Error recovery	Reset fault with → Controlword

**7.2.61 Auto tuning sample mismatch error**

Error code	0xFF15
Error register	0010 0000b
Cause	Sample data mismatched during auto tuning identification
Effect	Device disabled Red LED "ON" Error flag set in → Statusword
Error recovery	Reset fault with → Controlword

### 7.2.62 Auto tuning parameter error

Error code	0xFF16
Error register	0010 0000b
Cause	Wrong parameter for auto tuning identification. Error during identification auto tuning process
Effect	Device disabled Red LED "ON" Error flag set in → Statusword
Error recovery	Reset fault with → Controlword

### 7.2.63 Auto tuning amplitude mismatch error

Error code	0xFF17
Error register	0010 0000b
Cause	Nominal actual amplitude mismatch during auto tuning identification
Effect	Device disabled Red LED "ON" Error flag set in → Statusword
Error recovery	Reset fault with → Controlword

### 7.2.64 Auto tuning timeout error

Error code	0xFF19
Error register	0010 0000b
Cause	Auto tuning identification timeout. Termination requirements not met
Effect	Device disabled Red LED "ON" Error flag set in → Statusword
Error recovery	Reset fault with → Controlword

### 7.2.65 Auto tuning standstill error

Error code	0xFF20
Error register	0010 0000b
Cause	Motor did not reach standstill during auto tuning. Make sure that the motor is not moving when starting the tuning process.
Effect	Device disabled Red LED "ON" Error flag set in → Statusword
Error recovery	Reset fault with → Controlword

**7.2.66 Auto tuning torque invalid error**

Error code	0xFF21
Error register	0010 0000b
Cause	Motor movement has been obstructed during tuning process. This might, for example, be caused by the motor being connected to a rigid gear. Ensure that the motor movement is not obstructed.
Effect	Device disabled Red LED "ON" Error flag set in → Statusword
Error recovery	Reset fault with → Controlword

**7.2.67 Auto tuning max system speed error**

Error code	0xFF22
Error register	0010 0000b
Cause	Max system speed exceeded during auto tuning identification. Reduce step amplitude to reduce max speed.
Effect	Device disabled Red LED "ON" Error flag set in → Statusword
Error recovery	Reset fault with → Controlword

**7.2.68 Auto tuning motor connection error**

Error code	0xFF23
Error register	0010 0000b
Cause	Identification current is very small. Check the motor connection.
Effect	Device disabled Red LED "ON" Error flag set in → Statusword
Error recovery	Reset fault with → Controlword

**7.2.69 Auto tuning sensor signal error**

Error code	0xFF24
Error register	0010 0000b
Cause	Sensor signal was not found during tuning identification. Check the sensor and motor connections.
Effect	Device disabled Red LED "ON" Error flag set in → Statusword
Error recovery	Reset fault with → Controlword

### 7.3 CANopen Communication Errors (Abort Codes)

An abort object will be sent over the network instead of a response to a SDO request if the request has failed. The same abort code will be sent as part of the response to other transfer request (such as USB).

The following abort codes are defined by CANopen Communication Profile CiA 301. Codes greater 0x0F00 0000 are maxon-specific.

Abort code	Name	Cause
0x0000 0000	No abort	Communication successful
0x0503 0000	Toggle error	Toggle bit not alternated
0x0504 0000	SDO timeout	SDO protocol timed out
0x0504 0001	Command unknown	Command specifier unknown
0x0504 0004	CRC error	CRC check failed
0x0601 0000	Access error	Unsupported access to an object
0x0601 0001	Write only error	Read command to a write only object
0x0601 0002	Read only error	Write command to a read only object
0x0601 0003	Subindex cannot be written	Subindex cannot be written, subindex 0 must be "0" (zero) for write access
0x0601 0004	SDO complete access not supported	The object cannot be accessed via complete access
0x0602 0000	Object does not exist error	Last read or write command had wrong object index or subindex
0x0604 0041	PDO mapping error	Object is not mappable to the PDO
0x0604 0042	PDO length error	Number and length of objects to be mapped would exceed PDO length
0x0604 0043	General parameter error	General parameter incompatibility
0x0604 0047	General internal incompatibility error	General internal incompatibility in device
0x0606 0000	Hardware error	Access failed due to hardware error
0x0607 0010	Service parameter error	Data type does not match, length or service parameter do not match
0x0607 0013	Service parameter too short error	Data type does not match, length of service parameter too low
0x0609 0011	Subindex error	Last read or write command had wrong object subindex
0x0609 0030	Value range error	Value range of parameter exceeded
0x0800 0000	General error	General error
0x0800 0020	Transfer or store error	Data cannot be transferred or stored
0x0800 0022	Wrong device state error	Data cannot be transferred or stored to application because of present device state
0x0F00 FFBE	Password error	Password is incorrect
0x0F00 FFBF	Illegal command error	Command code is illegal (does not exist)
0x0F00 FFC0	Wrong NMT state error	Device is in wrong NMT state

Table 7-183 CANopen communication errors



## 7.4 EtherCAT FoE Error Codes

In the event of a communication error during a File over EtherCAT (FoE) transfer, the following error codes as defined in the ETG.1020 V1.2.0 EtherCAT Protocol Enhancements Specification (→[13]) will be used.

Error code	Name	Cause
0x8002	Access denied	Unsupported access to an object
0x8004	Illegal	Data cannot be transferred or stored to application due to present device state
0x8008	Bootstrap only	FoE download is supported in bootstrap state only
0x8009	Not bootstrap	The downloaded file is not accepted for firmware updates
0x800B	Program error	Firmware programming was aborted due to a general internal error
0x800C	Checksum wrong	The checksum of the downloaded file was wrong
0x800D	Firmware does not fit for hardware	The firmware file is incompatible to the device hardware
0x8011	Flash problem	The flash memory of the device could not be erased or programmed
0x8012	File incompatible	The firmware format is incompatible to the device

Table 7-184 EtherCAT FoE communication error codes

**••page intentionally left blank••**

## 8 FIRMWARE VERSION HISTORY

### 8.1 Version Overview

Date [yyyy-mm]	Version		Application		Description
	Software	Hardware	#	Version	
2021-04	0170h	6050h, 6150h, 6350h, 6450h, 6551h, 6552h, 6850h, 6950h, 6A50h, 6B50h	0000h	0000h	New hardware, new features, bug fixing
2020-04	0161h	6050h, 6150h, 6350h, 6450h, 6551h, 6552h, 6850h, 6950h	0000h	0000h	New hardware, bug fixing
2019-11	0160h	6050h, 6150h, 6350h, 6450h, 6551h, 6552h, 6850h	0000h	0000h	New hardware, new features, bug fixing
2018-12	0150h	6050h, 6150h, 6350h, 6450h, 6551h, 6552h	0000h	0000h	New hardware, new features, bug fixing
2018-06	0140h	6050h, 6150h, 6350h, 6450h, 6551h, 6552h	0000h	0000h	New hardware, new features, bug fixing
2017-12	0130h	6050h, 6150h, 6350h, 6551h, 6552h	0000h	0000h	New hardware, new features, bug fixing
2017-06	0120h	6050h, 6150h, 6350h, 6551h, 6552h	0000h	0000h	New hardware, new features, bug fixing
2016-11	0110h	6050h, 6150h, 6551h, 6552h	0000h	0000h	New hardware, new features, bug fixing
2016-06	0100h	6551h, 6552h	0000h	0000h	Initial release

Table 8-185 Version overview

## 8.2 Version History

EPOS4_0170h_xxxxh_0000h_0000h (Release 2021-04)		
<b>Binary Files</b>	EPOS4 Disk 60/8 CAN EPOS4 Disk 60/8 EtherCAT	EPOS4_0170h_6A50h_0000h_0000h.bin
	EPOS4 Disk 60/12 CAN EPOS4 Disk 60/12 CAN SSC EPOS4 Disk 60/12 EtherCAT EPOS4 Disk 60/12 EtherCAT SSC	EPOS4_0170h_6B50h_0000h_0000h.bin
	EPOS4 Micro 24/5 CAN	EPOS4_0170h_6850h_0000h_0000h.bin
	EPOS4 Micro 24/5 EtherCAT EPOS4 Compact 24/5 EtherCAT 3-axes	EPOS4_0170h_6950h_0000h_0000h.bin
	EPOS4 Module 24/1.5 EPOS4 Compact 24/1.5 CAN EPOS4 Compact 24/1.5 EtherCAT	EPOS4_0170h_6050h_0000h_0000h.bin
	EPOS4 Module 50/5 EPOS4 Compact 50/5 CAN EPOS4 Compact 50/5 EtherCAT	EPOS4_0170h_6150h_0000h_0000h.bin
	EPOS4 Module 50/8 EPOS4 Compact 50/8 CAN EPOS4 Compact 50/8 EtherCAT	EPOS4_0170h_6551h_0000h_0000h.bin
	EPOS4 Module 50/15 EPOS4 Compact 50/15 CAN EPOS4 Compact 50/15 EtherCAT	EPOS4_0170h_6552h_0000h_0000h.bin
	EPOS4 50/5	EPOS4_0170h_6350h_0000h_0000h.bin
	EPOS4 70/15	EPOS4_0170h_6450h_0000h_0000h.bin
<b>Features</b>	Introduction	«EPOS4 Disk 60/8 CAN» / «EPOS4 Disk 60/8 EtherCAT» / «EPOS4 Disk 60/12 CAN» / «EPOS4 Disk 60/12 CAN SSC» / «EPOS4 Disk 60/12 EtherCAT» / «EPOS4 Disk 60/12 EtherCAT SSC»
	Position window	Position window functionality for PPM and HMM added
	Controller identification	Optical node identification by blinking LED added
	System monitoring	Actual PWM duty cycle object added
	Drive protection	Objects to configure the undervoltage, overvoltage, and thermal overload error limits added
	Error behavior	NMT state in case of CAN heartbeat error is new configurable
	Digital incremental encoder	Configuration for 3-channel encoder without index supervision added
	SSI encoder	Homing methods with (virtual) index added

Continued on next page.

EPOS4_0170h_xxxxh_0000h_0000h (Release 2021-04)		
<b>Changes</b>	CAN communication	Support of Node-ID 255 (undefined) added (used as default value if no valid preset)
	EtherCAT communication	Check of minimal cycle time added. Process data latency improved.
	Regulation tuning	Improvements and corrections in regulation tuning system identification
	Velocity controller	Velocity controller filter cut off frequency object (0x30A2; 0x05) added
	Position controller	Position controller I gain scaling object (0x30A1; 0x09) added
	System monitoring	System overload signalization changed to warning (instead of error)
	Bugfix	Touch probe: occasionally wrong sensor index detection corrected
	Bugfix	CAN PDO: unexpected "CAN Rx queue overflow error" at overlapping PDO and SYNC frames fixed
	Bugfix	PPM with dual loop configuration: sporadic trajectory discontinuity corrected
	Bugfix	General minor bug fixing and improvements

EPOS4_0161h_xxxxh_0000h_0000h (Release 2020-04)		
<b>Binary Files</b>	EPOS4 Micro 24/5 CAN	EPOS4_0161h_6850h_0000h_0000h.bin
	EPOS4 Micro 24/5 EtherCAT EPOS4 Compact 24/5 EtherCAT 3-axes	EPOS4_0161h_6950h_0000h_0000h.bin
	EPOS4 Module 24/1.5 EPOS4 Compact 24/1.5 CAN EPOS4 Compact 24/1.5 EtherCAT	EPOS4_0161h_6050h_0000h_0000h.bin
	EPOS4 Module 50/5 EPOS4 Compact 50/5 CAN EPOS4 Compact 50/5 EtherCAT	EPOS4_0161h_6150h_0000h_0000h.bin
	EPOS4 Module 50/8 EPOS4 Compact 50/8 CAN EPOS4 Compact 50/8 EtherCAT	EPOS4_0161h_6551h_0000h_0000h.bin
	EPOS4 Module 50/15 EPOS4 Compact 50/15 CAN EPOS4 Compact 50/15 EtherCAT	EPOS4_0161h_6552h_0000h_0000h.bin
	EPOS4 50/5	EPOS4_0161h_6350h_0000h_0000h.bin
	EPOS4 70/15	EPOS4_0161h_6450h_0000h_0000h.bin
	<b>Features</b>	Introduction
<b>Changes</b>	Bugfix	Transfer of occasionally incorrect actual position values via EtherCAT resolved

EPOS4_0160h_xxxxh_0000h_0000h (Release 2019-11)		
<b>Binary Files</b>	EPOS4 Micro 24/5 CAN	EPOS4_0160h_6850h_0000h_0000h.bin
	EPOS4 Module 24/1.5 EPOS4 Compact 24/1.5 CAN EPOS4 Compact 24/1.5 EtherCAT	EPOS4_0160h_6050h_0000h_0000h.bin
	EPOS4 Module 50/5 EPOS4 Compact 50/5 CAN EPOS4 Compact 50/5 EtherCAT	EPOS4_0160h_6150h_0000h_0000h.bin
	EPOS4 Module 50/8 EPOS4 Compact 50/8 CAN EPOS4 Compact 50/8 EtherCAT	EPOS4_0160h_6551h_0000h_0000h.bin
	EPOS4 Module 50/15 EPOS4 Compact 50/15 CAN EPOS4 Compact 50/15 EtherCAT	EPOS4_0160h_6552h_0000h_0000h.bin
	EPOS4 50/5	EPOS4_0160h_6350h_0000h_0000h.bin
	EPOS4 70/15	EPOS4_0160h_6450h_0000h_0000h.bin
<b>Features</b>	Introduction	«EPOS4 Micro 24/5 CAN»
	Analog I/O	Analog set value functionality for CST and CSV added
	Communication	CANopen LSS to configure Node-ID and bit rate and for optical node identification added
	Digital I/O	Digital input functionality «Touch probe» added
	SSI encoder	Extended SSI interface for single-turn and multi-turn encoders and up to 62 data bits with configurable mapping to 32 bit position value
<b>Changes</b>	STO	Display of STO state added
	Bugfix	Watchdog error for cyclic NMT command “reset communication” resolved
	Bugfix	Dual loop inconsistent velocity display during tuning resolved
	Bugfix	Max motor speed limitation not applied during tuning resolved
	Bugfix	Inconsistent communication during bootup over USB and RS232 resolved
	Bugfix	Blocking velocity ramps on activating CSV resolved
	Bugfix	General minor bug fixing and improvements

EPOS4_0150h_xxxxh_0000h_0000h (Release 2018-12)		
<b>Binary Files</b>	EPOS4 Module 24/1.5 EPOS4 Compact 24/1.5 CAN EPOS4 Compact 24/1.5 EtherCAT	EPOS4_0150h_6050h_0000h_0000h.bin
	EPOS4 Module 50/5 EPOS4 Compact 50/5 CAN EPOS4 Compact 50/5 EtherCAT	EPOS4_0150h_6150h_0000h_0000h.bin
	EPOS4 Module 50/8 EPOS4 Compact 50/8 CAN EPOS4 Compact 50/8 EtherCAT	EPOS4_0150h_6551h_0000h_0000h.bin
	EPOS4 Module 50/15 EPOS4 Compact 50/15 CAN EPOS4 Compact 50/15 EtherCAT	EPOS4_0150h_6552h_0000h_0000h.bin
	EPOS4 50/5	EPOS4_0150h_6350h_0000h_0000h.bin
	EPOS4 70/15	EPOS4_0150h_6450h_0000h_0000h.bin
<b>Features</b>	Introduction	«EPOS4 Compact 24/1.5 EtherCAT» / «EPOS4 Compact 50/5 EtherCAT»
	Regulation	Dual loop control added
	Regulation tuning	Regulation tuning for dual loop control added
	EtherCAT interface	Firmware update via EtherCAT interface (FoE) added
	USB-to-CAN gateway	Firmware update via USB-to-CAN gateway added
	Communication	NMT commands for USB-to-CAN and RS232-to-CAN gateway added
	Analog outputs	General purpose functionality for analog outputs added
	Analog inputs	Adjustment objects for gain and offset added
	Incremental encoder	Encoder index signal supervision added
<b>Changes</b>	Incremental encoder	Measuring of encoder speed enhanced by detection of time between consecutive sensor edges.
	Hall sensors	Measuring of sensor speed enhanced by detection of time between consecutive sensor edges.
	SI units	SI unit velocity extended by units $10^{-4}$ [rpm], $10^{-5}$ [rpm] and [µrpm]
	Regulation tuning	Current control loop tuning improved
	USB interface	USB communication stability during firmware update improved
	CAN PDO	CAN PDO communication performance improved
	Bugfix	Sporadic "CAN overrun error" caused by excessive NMT command traffic solved
	Bugfix	RS232 blocking at high communication rate solved
	Bugfix	PVM statusword: Target reached signalization corrected
	Bugfix	EtherCAT status LED signalization according to ETG specification corrected
Bugfix	General minor bug fixing and improvements	

**EPOS4\_0140h\_xxxxh\_0000h\_0000h (Release 2018-05)**

<b>Binary Files</b>	EPOS4 Module 24/1.5 EPOS4 Compact 24/1.5 CAN	EPOS4_0140h_6050h_0000h_0000h.bin
	EPOS4 Module 50/5 EPOS4 Compact 50/5 CAN	EPOS4_0140h_6150h_0000h_0000h.bin
	EPOS4 Module 50/8 EPOS4 Compact 50/8 CAN EPOS4 Compact 50/8 EtherCAT	EPOS4_0140h_6551h_0000h_0000h.bin
	EPOS4 Module 50/15 EPOS4 Compact 50/15 CAN EPOS4 Compact 50/15 EtherCAT	EPOS4_0140h_6552h_0000h_0000h.bin
	EPOS4 50/5	EPOS4_0140h_6350h_0000h_0000h.bin
	EPOS4 70/15	EPOS4_0140h_6450h_0000h_0000h.bin
<b>Features</b>	Introduction	«EPOS4 Compact 50/8 EtherCAT» / «EPOS4 Compact 50/15 EtherCAT» / «EPOS4 70/15»
	Communication	Firmware update via CAN interface added
	Incremental encoder 2	Support of second incremental encoder added
	Analog incremental encoder SinCos	Support of Analog incremental encoder SinCos added
	Modes of operation	Cyclic Synchronous Velocity (CSV) added
	Gear	Support of systems with attached gear added
<b>Changes</b>	Power supply	Powering of device via USB only suppressed
	Homing	Homing mode extended by methods featuring "current threshold"
	Incremental encoder	Measuring of sensor speed enhanced by detection of encoder pulse time
	Sensor supervision	Sensor supervision extended for the case of different main and commutation sensors
	SI units	SI unit velocity extended by units drpm, crpm and mrpm
	Regulation tuning	Data type of object "Electrical resistance" adapted
	Motor protection	Objects "I2t level motor" and "I2t level controller" changed to PDO mappable
	Device description	Full device name added to EtherCAT slave information file (ESI)
	Software position limits	Software position limits are also activated in unreferenced state
	Trajectory generator	Stability of trajectory generator improved

Continued on next page.



## EPOS4\_0140h\_xxxxh\_0000h\_0000h (Release 2018-05)

<b>Changes (cont.)</b>	Hall sensors	Spike filtering improved
	Profile Position Mode	PPM controlword: Handling of new setpoint and halt flag deactivation improved
	Bugfix	PPM: Sporadic spikes on demand value when immediately commanding target values solved
	Bugfix	PPM statusword: Spikes on set point acknowledge bit signalization during state change to quick stop or halt command corrected
	Bugfix	PVM statusword: Spikes on speed bit signalization during state change to quick stop corrected
	Bugfix	CSP: Target position value interpolation improved
	Bugfix	Deadlock caused by domain object access via EtherCAT with wrong data size solved
	Bugfix	Sporadic "CAN Rx queue overflow error" with inactive CAN interface solved
	Bugfix	Wrong CAN COB-IDs display during CAN bus initialization fixed
	Bugfix	General minor bug fixing and improvements

EPOS4_0130h_xxxxh_0000h_0000h (Release 2017-12)		
<b>Binary Files</b>	EPOS4 Module 24/1.5 EPOS4 Compact 24/1.5 CAN	EPOS4_0130h_6050h_0000h_0000h.bin
	EPOS4 Module 50/5 EPOS4 Compact 50/5 CAN	EPOS4_0130h_6150h_0000h_0000h.bin
	EPOS4 Module 50/8 EPOS4 Compact 50/8 CAN	EPOS4_0130h_6551h_0000h_0000h.bin
	EPOS4 Module 50/15 EPOS4 Compact 50/15 CAN	EPOS4_0130h_6552h_0000h_0000h.bin
	EPOS4 50/5	EPOS4_0130h_6350h_0000h_0000h.bin
<b>Features</b>	Introduction	EPOS4 EtherCAT extension
	Communication	EtherCAT communication (CoE) for EPOS4 accessories with EtherCAT extension added
	Modes of operation	Cyclic Synchronous Position (CSP) added
	Custom persistent memory	Object to store custom values added
<b>Changes</b>	Bugfix	Position controller: anti-windup behavior improved
	Bugfix	Analog inputs: Display of negative values corrected
	Bugfix	SSI encoder: Reading special bits fixed
	Bugfix	CAN gateway: Sporadic watchdog error fixed
	Bugfix	CAN: Automatic bit rate detection fixed
	Bugfix	Statusword: Internal limit signalization corrected
	Bugfix	CST statusword: Drive follows command signalization corrected
Bugfix	General minor bug fixing and improvements	

## EPOS4\_0120h\_xxxxh\_0000h\_0000h (Release 2017-06)

<b>Binary Files</b>	EPOS4 Module 24/1.5 EPOS4 Compact 24/1.5 CAN	EPOS4_0120h_6050h_0000h_0000h.bin
	EPOS4 Module 50/5 EPOS4 Compact 50/5 CAN	EPOS4_0120h_6150h_0000h_0000h.bin
	EPOS4 Module 50/8 EPOS4 Compact 50/8 CAN	EPOS4_0120h_6551h_0000h_0000h.bin
	EPOS4 Module 50/15 EPOS4 Compact 50/15 CAN	EPOS4_0120h_6552h_0000h_0000h.bin
	EPOS4 50/5	EPOS4_0120h_6350h_0000h_0000h.bin
<b>Features</b>	Introduction	«EPOS4 50/5»
	SSI encoder	EC (BLDC) motor commutation by SSI absolute encoder only (without Hall sensors) added
	Digital I/Os	Digital input functionality «Drive enable» and «Quick stop» added
	Watchdog	Watchdog handling (including error signalization) added
<b>Changes</b>	CAN PDO	CAN PDO communication performance improved
	System monitoring	System performance monitoring (including error signalization) improved
	Bugfix	PVM statusword: Target reached signalization at velocity limitation corrected
	Bugfix	Mechanical tuning: Error handling at wrong torque constant detection improved

**EPOS4\_0110h\_xxxxh\_0000h\_0000h (Release 2016-11)**

<b>Binary Files</b>	EPOS4 Module 24/1.5 EPOS4 Compact 24/1.5 CAN	EPOS4_0110h_6050h_0000h_0000h.bin
	EPOS4 Module 50/5 EPOS4 Compact 50/5 CAN	EPOS4_0110h_6150h_0000h_0000h.bin
	EPOS4 Module 50/8 EPOS4 Compact 50/8 CAN	EPOS4_0110h_6551h_0000h_0000h.bin
	EPOS4 Module 50/15 EPOS4 Compact 50/15 CAN	EPOS4_0110h_6552h_0000h_0000h.bin
<b>Features</b>	Introduction	«EPOS4 Module 24/1.5» / «EPOS4 Compact 24/1.5 CAN» / «EPOS4 Module 50/5» / «EPOS4 Compact 50/15 CAN»
	RS232 interface	RS232 communication interface added
	USB to CAN gateway	Basic USB-to-CAN gateway functionality (SDO communication only)
	RS232 to CAN gateway	Basic RS232-to-CAN gateway functionality (SDO communication only)
	SSI encoder	Support of SSI absolute encoders added
	Holding brake	Autonomous control of a holding brake based on the device state added
	Software position limits	Software position limits functionality added
<b>Changes</b>	Digital I/Os	Default values of object "Digital input configuration" (0x3142) adapted
	CAN heartbeat	Stability of heartbeat consumer improved
	Regulation Tuning	Object "Electrical system parameters" (0x3002) added
	Device state machine	Behavior at enabling while actual velocity is not zero improved
		Standstill window functionality added to detect standstill condition of the axis
	USB interface	Sensor handling at USB bus powering improved
	Bugfix	Wrong resetting of communication parameters to default value after firmware update fixed
	Bugfix	Sporadic Hall angle detection errors during alignment solved
	Bugfix	CAN PDO configuration handling corrected
	Bugfix	Data recorder: sporadic wrong recording data due to time stamp overflow solved
Bugfix	Current offset calibration improved to prevent sporadic wrong current offset values	
Bugfix	Sporadic communication blockage during boot up eliminated	

EPOS4_0100h_xxxxh_0000h_0000h (Release 2016-06)		
<b>Binary Files</b>	EPOS4 Module 50/8 EPOS4 Compact 50/8 CAN	EPOS4_0100h_6551h_0000h_0000h.bin
	EPOS4 Module 50/15 EPOS4 Compact 50/15 CAN	EPOS4_0100h_6552h_0000h_0000h.bin
<b>Features</b>	Full range	Initial release

**••page intentionally left blank••**

## LIST OF FIGURES

Figure 1-1	Documentation structure . . . . .	9
Figure 2-2	Communication architecture . . . . .	15
Figure 2-3	Device State Machine . . . . .	16
Figure 3-4	Functional architecture . . . . .	21
Figure 3-5	Profile Position Mode – Block diagram . . . . .	23
Figure 3-6	Profile position trajectory – Linear ramp (trapezoidal profile) . . . . .	24
Figure 3-7	Profile Position Mode – Setpoint (example) . . . . .	26
Figure 3-8	Profile Velocity Mode – Block diagram . . . . .	27
Figure 3-9	Profile velocity trajectory – Linear ramp (trapezoidal profile) . . . . .	27
Figure 3-10	Profile velocity trajectory – Setpoint and acceleration behavior (example) . . . . .	29
Figure 3-11	Homing Mode – Block diagram . . . . .	30
Figure 3-12	Homing trajectory – Linear ramp (trapezoidal profile) . . . . .	30
Figure 3-13	Homing method 1 . . . . .	33
Figure 3-14	Homing method 2 . . . . .	33
Figure 3-15	Homing method 7 . . . . .	34
Figure 3-16	Homing method 11 . . . . .	34
Figure 3-17	Homing method 17 . . . . .	35
Figure 3-18	Homing method 18 . . . . .	35
Figure 3-19	Homing method 23 . . . . .	35
Figure 3-20	Homing method 27 . . . . .	36
Figure 3-21	Homing method 33 . . . . .	36
Figure 3-22	Homing method 34 . . . . .	36
Figure 3-23	Homing method 37 . . . . .	37
Figure 3-24	Homing method -1 . . . . .	37
Figure 3-25	Homing method -2 . . . . .	37
Figure 3-26	Homing method -3 . . . . .	38
Figure 3-27	Homing method -4 . . . . .	38
Figure 3-28	Cyclic Synchronous Position Mode – Overview . . . . .	39
Figure 3-29	Cyclic Synchronous Position Mode – Block diagram . . . . .	40
Figure 3-30	Cyclic Synchronous Velocity Mode – Overview . . . . .	43
Figure 3-31	Cyclic Synchronous Velocity Mode – Block diagram . . . . .	43
Figure 3-32	Cyclic Synchronous Torque Mode – Overview . . . . .	46
Figure 3-33	Cyclic Synchronous Torque Mode – Block diagram . . . . .	46
Figure 3-34	Position Control Function – Block diagram . . . . .	49
Figure 3-35	Velocity Control Function – Block diagram . . . . .	51
Figure 3-36	Current Control Function – Block diagram . . . . .	53
Figure 3-37	Standardized peak current vs. standardized peak current time . . . . .	54
Figure 3-38	Cyclic mode standardized vs. standardized “ON time” . . . . .	55
Figure 4-39	Digital input functionality . . . . .	57
Figure 4-40	Digital output functionality . . . . .	59
Figure 4-41	Analog input functionality . . . . .	60

Figure 4-42	Analog output functionality . . . . .	61
Figure 6-43	SSI encoder – Data rate vs. cable length . . . . .	160
Figure 6-44	SSI encoder – Data frame . . . . .	161
Figure 6-45	SSI encoder – Timing . . . . .	163
Figure 6-46	Block commutation of EC (BLDC) motors – Definition of phases . . . . .	165
Figure 6-47	SSI encoder – Data bits . . . . .	166
Figure 6-48	Standstill window . . . . .	191
Figure 6-49	Holding brake activation timing (digital output polarity “High active”) . . . . .	200
Figure 6-50	Analog input current set value properties – Setpoint function . . . . .	207
Figure 6-51	Analog input current set value properties – Set value . . . . .	207
Figure 6-52	Analog input velocity set value properties – Setpoint function . . . . .	210
Figure 6-53	Analog input velocity set value properties – Set value . . . . .	210
Figure 6-54	Position window . . . . .	229



## LIST OF TABLES

Table 1-1	Notations used . . . . .	10
Table 1-2	Abbreviations & acronyms used . . . . .	10
Table 1-3	Brand names and trademark owners . . . . .	11
Table 1-4	Sources for additional information . . . . .	12
Table 2-5	Device state bits . . . . .	17
Table 2-6	Device state transitions . . . . .	18
Table 2-7	Axis control commands . . . . .	18
Table 2-8	User-defined units – Parameter structure . . . . .	19
Table 2-9	SI units – Notation index . . . . .	19
Table 2-10	CiA 402 Application profile-specific units – Notation index . . . . .	19
Table 2-11	Unit prefixes – Notation index . . . . .	20
Table 3-12	Profile Position Mode – Configuration parameters . . . . .	24
Table 3-13	Profile Position Mode – Commanding parameters . . . . .	25
Table 3-14	Profile Position Mode – Controlword . . . . .	25
Table 3-15	Profile Position Mode – Controlword bits . . . . .	25
Table 3-16	Profile Position Mode – Output parameters . . . . .	25
Table 3-17	Profile Position Mode – Statusword . . . . .	26
Table 3-18	Profile Position Mode – Statusword bits . . . . .	26
Table 3-19	Profile Velocity Mode – Configuration parameters . . . . .	28
Table 3-20	Profile Velocity Mode – Commanding parameters . . . . .	28
Table 3-21	Profile Velocity Mode – Controlword . . . . .	28
Table 3-22	Profile Velocity Mode – Controlword bits . . . . .	28
Table 3-23	Profile Velocity Mode – Output parameters . . . . .	29
Table 3-24	Profile Velocity Mode – Statusword . . . . .	29
Table 3-25	Profile Velocity Mode – Statusword bits . . . . .	29
Table 3-26	Homing Mode – Configuration parameters . . . . .	31
Table 3-27	Homing Mode – Commanding parameters . . . . .	31
Table 3-28	Homing Mode – Controlword . . . . .	31
Table 3-29	Homing Mode – Controlword bits . . . . .	31
Table 3-30	Homing Mode – Output parameters . . . . .	32
Table 3-31	Homing Mode – Statusword . . . . .	32
Table 3-32	Homing Mode – Statusword bit 15 . . . . .	32
Table 3-33	Homing Mode – Statusword bits 10, 12, and 13 . . . . .	32
Table 3-34	Cyclic Synchronous Position Mode – Configuration parameters . . . . .	41
Table 3-35	Cyclic Synchronous Position Mode – Commanding parameters . . . . .	41
Table 3-36	Cyclic Synchronous Position Mode – Output parameters . . . . .	42
Table 3-37	Cyclic Synchronous Position Mode – Statusword . . . . .	42
Table 3-38	Cyclic Synchronous Position Mode – Statusword bits . . . . .	42
Table 3-39	Cyclic Synchronous Velocity Mode – Configuration parameters . . . . .	44
Table 3-40	Cyclic Synchronous Velocity Mode – Commanding parameters . . . . .	44
Table 3-41	Cyclic Synchronous Velocity Mode – Output parameters . . . . .	44

Table 3-42	Cyclic Synchronous Velocity Mode – Statusword	45
Table 3-43	Cyclic Synchronous Velocity Mode – Statusword bits	45
Table 3-44	Cyclic Synchronous Torque Mode – Configuration parameters	47
Table 3-45	Cyclic Synchronous Torque Mode – Commanding parameters	47
Table 3-46	Cyclic Synchronous Torque Mode – Output parameters	47
Table 3-47	Cyclic Synchronous Torque Mode – Statusword	48
Table 3-48	Cyclic Synchronous Torque Mode – Statusword bits	48
Table 3-49	Position Control Function – Configuration parameters	49
Table 3-50	Position Control Function – Output parameters	50
Table 3-51	Velocity Control Function – Configuration parameters	51
Table 3-52	Velocity Control Function – Output Parameters	52
Table 3-53	Current Control Function – Configuration parameters	53
Table 3-54	Current Control Function – Output parameters	54
Table 6-55	Object data types	65
Table 6-56	Object codes	65
Table 6-57	Object access types	65
Table 6-58	Object flags	66
Table 6-59	Object Dictionary (overview)	69
Table 6-60	Error register bits	70
Table 6-61	Error history structure	72
Table 6-62	Store parameters signature	74
Table 6-63	Store parameters state	74
Table 6-64	Restore default parameters signature	75
Table 6-65	Consumer heartbeat time – Structure	76
Table 6-66	Definition of hardware version	78
Table 6-67	Error behavior in case of CAN heartbeat error	80
Table 6-68	Newest acknowledged message – Read/Write bits	82
Table 6-69	Flags – Read/Write bits	83
Table 6-70	Diagnosis messages	84
Table 6-71	COB-ID used by RxPDO – Structure	86
Table 6-72	COB-ID used by RxPDO – Description	86
Table 6-73	Receive PDO mapping – Structure of mapped object	91
Table 6-74	Receive PDO 1 mapping	92
Table 6-75	Receive PDO 2 mapping	94
Table 6-76	Receive PDO 3 mapping	95
Table 6-77	Receive PDO 4 mapping	97
Table 6-78	COB-ID used by TxPDO – Structure	98
Table 6-79	COB-ID used by TxPDO – Description	98
Table 6-80	Transmit PDO mapping – Structure of mapped object	104
Table 6-81	Transmit PDO 1 mapping	105
Table 6-82	Transmit PDO 2 mapping	107
Table 6-83	Transmit PDO 3 mapping	108
Table 6-84	Transmit PDO 4 mapping	110
Table 6-85	SYNC mode output parameters	114

Table 6-86	Synchronization types supported – Output parameters	115
Table 6-87	Sync values	117
Table 6-88	SYNC mode input parameters	118
Table 6-89	Synchronization types supported – Input parameters	119
Table 6-90	Sync values	121
Table 6-91	Program control – Value range	122
Table 6-92	Program software identification – Value range	123
Table 6-93	Flash status identification – Value range	125
Table 6-94	CAN bit rate	127
Table 6-95	RS232 bit rate	128
Table 6-96	Fieldbus type	130
Table 6-97	Extension 1 hardware – Version definition	132
Table 6-98	Extension communication type	133
Table 6-99	Power supply voltage – Undervoltage limit	136
Table 6-100	Power supply voltage – Hysteresis	136
Table 6-101	Power supply voltage – Overvoltage limit	137
Table 6-102	Sensor configuration – Bits	138
Table 6-103	Supported sensor types	139
Table 6-104	Control structure – Bits	140
Table 6-105	Control structure without gear – permitted values	141
Table 6-106	Control structure with gear – permitted values	144
Table 6-107	Control structure with gear and dual loop control – permitted values	146
Table 6-108	Commutation sensors – Bits	147
Table 6-109	Commutation sensors – Value range	147
Table 6-110	Axis configuration miscellaneous – Bits	148
Table 6-111	Max system speed – Limits	149
Table 6-112	Max system speed – Speed limitations based on velocity units	149
Table 6-113	Nominal current	151
Table 6-114	Output current limit	151
Table 6-115	Gear velocity limits	155
Table 6-116	Gear miscellaneous configuration – Bits	155
Table 6-117	Digital incremental encoder 1 type – Bits	157
Table 6-118	Analog incremental encoder type – Bits	158
Table 6-119	Analog incremental encoder resolution – Bits	159
Table 6-120	SSI encoder – Number of data bits	161
Table 6-121	SSI encoder – Protocol	162
Table 6-122	SSI position bits	166
Table 6-123	Digital Hall sensor – Bits	168
Table 6-124	Digital Hall sensor – Pattern	169
Table 6-125	Digital incremental encoder 2 type – Bits	171
Table 6-126	SI units velocity – Bits	175
Table 6-127	SI units velocity – Value range	175
Table 6-128	Dual loop configuration miscellaneous – Bits	186
Table 6-129	Digital input bits	193

Table 6-130	Digital inputs – Default values	195
Table 6-131	Digital inputs – Configuration	196
Table 6-132	Digital output bits	197
Table 6-133	Digital outputs – Default values	198
Table 6-134	Digital outputs – Configuration	198
Table 6-135	High-speed digital output 2 – Configuration	199
Table 6-136	Holding brake states	201
Table 6-137	Analog inputs – Default values	204
Table 6-138	Analog inputs – Configuration	204
Table 6-139	Analog outputs – Default values	213
Table 6-140	Analog outputs – Configuration	213
Table 6-141	Maximal temperature power stage	217
Table 6-142	STO input states	218
Table 6-143	Abort connection option code	219
Table 6-144	Controlword bits	221
Table 6-145	Statusword bits	223
Table 6-146	Quick stop option code	223
Table 6-147	Shutdown option code	224
Table 6-148	Disable operation option code	224
Table 6-149	Fault reaction option code	225
Table 6-150	Modes of operation	226
Table 6-151	Max motor speed	235
Table 6-152	Motion profile types	237
Table 6-153	Homing methods	238
Table 6-154	SI units position – Bits	240
Table 6-155	SI units position – Value range	240
Table 6-156	SI units velocity – Bits	241
Table 6-157	SI units velocity – Value range	241
Table 6-158	SI units acceleration – Bits	242
Table 6-159	SI units acceleration – Value range	242
Table 6-160	Touch probe function	244
Table 6-161	Touch probe status	245
Table 6-162	Touch probe 1 source	249
Table 6-163	Touch probe 1 positive edge counter	250
Table 6-164	Touch probe 1 negative edge counter	250
Table 6-165	Digital inputs	261
Table 6-166	Digital outputs	262
Table 6-167	Motor types	263
Table 6-168	Supported drive modes – Bits	264
Table 6-169	Configured module identification – Bits	266
Table 6-170	Configured module identification types	267
Table 6-171	MDP module PPM mapping – Default values for RxPDO	268
Table 6-172	MDP module PPM mapping – Default values for TxPDO	268
Table 6-173	MDP module PVM mapping – Default values for RxPDO	269

Table 6-174	MDP module PVM mapping – Default values for TxPDO .....	269
Table 6-175	MDP module CSP mapping – Default values for RxPDO .....	270
Table 6-176	MDP module CSP mapping – Default values for TxPDO .....	270
Table 6-177	MDP module CSV mapping – Default values for RxPDO .....	271
Table 6-178	MDP module CSV mapping – Default values for TxPDO .....	271
Table 6-179	MDP module CST mapping – Default values for RxPDO .....	272
Table 6-180	MDP module CST mapping – Default values for TxPDO .....	272
Table 7-181	Emergency message frame .....	273
Table 7-182	Device error codes .....	275
Table 7-183	CANopen communication errors .....	292
Table 7-184	EtherCAT FoE communication error codes .....	293
Table 8-185	Version overview .....	295

••page intentionally left blank••

## INDEX

### Numerics

- 1st assigned RxPDO (object) 112
  - 1st assigned TxPDO (object) 113
  - 1st mapped object in RxPDO 1 (object) 92
  - 1st mapped object in RxPDO 2 (object) 93
  - 1st mapped object in RxPDO 3 (object) 95
  - 1st mapped object in RxPDO 4 (object) 96
  - 1st mapped object in TxPDO 1 (object) 105
  - 1st mapped object in TxPDO 2 (object) 106
  - 1st mapped object in TxPDO 3 (object) 108
  - 1st mapped object in TxPDO 4 (object) 109
  - 1st supported homing method (object) 251
  - 2nd supported homing method (object) 251
  - 3rd supported homing method (object) 252
  - 4th supported homing method (object) 252
  - 5th supported homing method (object) 252
  - 6th supported homing method (object) 253
  - 7th supported homing method (object) 253
  - 8th supported homing method (object) 253
  - 9th supported homing method (object) 254
  - 10th supported homing method (object) 254
  - 11th supported homing method (object) 254
  - 12th supported homing method (object) 255
  - 13th supported homing method (object) 255
  - 14th supported homing method (object) 255
  - 15th supported homing method (object) 256
- ### A
- abbreviations & acronyms 10
  - abort codes 292
  - Abort connection option code (object) 219
  - Access denied (error code) 293
  - Access error (abort code) 292
  - access types 65
  - Active fieldbus (object) 130
  - Additional identity (object) 131
  - Additional position actual values (object) 256
  - Additional velocity actual values (object) 258
  - Analog incremental encoder (object) 158
  - Analog incremental encoder index position (object) 159
  - Analog incremental encoder resolution (object) 159
  - Analog incremental encoder type (object) 158
  - Analog input 1...2 adjustment offset (object) 206
  - Analog input 1...2 configuration (object) 204
  - Analog input 1...2 voltage (object) 203
  - Analog input adjustment (object) 206
  - Analog input current set value properties (object) 207
  - analog input functionality 60
  - Analog input general purpose (object) 205
  - Analog input general purpose A...B (object) 205
  - Analog input properties (object) 203
  - Analog input velocity set value properties (object) 210
  - Analog output 1...2 configuration (object) 213
  - Analog output 1...2 voltage (object) 212
  - analog output functionality 61
  - Analog output general purpose (object) 214
  - Analog output general purpose A...B (object) 214
  - Analog output properties (object) 212
  - applicable EU directive 13
  - Auto tuning amplitude mismatch error (error message) 290
  - Auto tuning current limit error (error message) 289
  - Auto tuning data sampling error (error message) 289
  - Auto tuning identification current error (error message) 289
  - Auto tuning identification error (error message) 289
  - Auto tuning max system speed error (error message) 291
  - Auto tuning motor connection error (error message) 291
  - Auto tuning parameter error (error message) 290
  - Auto tuning sample mismatch error (error message) 289
  - Auto tuning sensor signal error (error message) 291
  - Auto tuning standstill error (error message) 290
  - Auto tuning timeout error (error message) 290
  - Auto tuning torque invalid error (error message) 291
  - Auxiliary loop FF acceleration gain (object) 184
  - Auxiliary loop FF velocity gain (object) 183
  - Auxiliary loop I gain (object) 183
  - Auxiliary loop observer friction (object) 185
  - Auxiliary loop observer inertia (object) 185
  - Auxiliary loop observer load correction gain (object) 185
  - Auxiliary loop observer position correction gain (object) 184
  - Auxiliary loop observer velocity correction gain (object) 184
  - Auxiliary loop P gain (object) 183
  - Axis configuration (object) 138
  - Axis configuration miscellaneous (object) 148
- ### B
- binary files 295
  - bit rate
    - CAN 127
    - RS232 128
  - Bootstrap only (error code) 293

**C**

Calc and copy time (object) 116, 120  
 CAN bit rate (object) 127  
 CAN bit rate display (object) 130  
 CAN bus turned off (error message) 285  
 CAN heartbeat error (error message) 284  
 CAN overrun error (error message) 283  
 CAN overrun error (object lost) (error message) 283  
 CAN passive mode error (error message) 284  
 CAN PDO COB-ID collision (error message) 284  
 CAN PDO length error (error message) 286  
 CAN Rx queue overflow (error message) 286  
 CAN Tx queue overflow (error message) 286  
 CANopen communication errors 292  
 Checksum wrong (error code) 293  
 COB-ID EMCY (object) 75  
 COB-ID SDO client to server (object) 85  
 COB-ID SDO server to client (object) 85  
 COB-ID SYNC (object) 72  
 COB-ID used by RxPDO 1 (object) 86  
 COB-ID used by RxPDO 2 (object) 88  
 COB-ID used by RxPDO 3 (object) 89  
 COB-ID used by RxPDO 4 (object) 90  
 COB-ID used by TxPDO 1 (object) 97  
 COB-ID used by TxPDO 2 (object) 99  
 COB-ID used by TxPDO 3 (object) 101  
 COB-ID used by TxPDO 4 (object) 102  
 Command unknown (abort code) 292  
 communication 63  
 Communication error (object) 80  
 Communication type SYNC channel 0 (object) 111  
 Communication type SYNC channel 1 (object) 111  
 Communication type SYNC channel 2 (object) 111  
 Communication type SYNC channel 3 (object) 111  
 Commutation sensors (object) 147  
 Configuration of analog inputs (object) 204  
 Configuration of analog outputs (object) 213  
 Configuration of digital inputs (object) 195  
 Configuration of digital outputs (object) 198  
 Configured module ident list (object) 266  
 Consumer 1...2 heartbeat time (object) 76  
 Consumer heartbeat time (object) 76  
 Control structure (object) 140  
 Controller gain error (error message) 288  
 Controlword (object) 221  
 CRC error (abort code) 292  
 CST (Cyclic Synchronous Torque Mode) 46  
 CSV (Cyclic Synchronous Velocity Mode) 43  
 current (units) 19  
 Current actual value (object) 188  
 Current actual value averaged (object) 188  
 Current actual values (object) 188  
 Current control parameter set (object) 172  
 Current controller I gain (object) 172

Current controller P gain (object) 172  
 Current demand value (object) 187  
 Current set value first current (object) 208  
 Current set value first voltage (object) 208  
 Current set value second current (object) 209  
 Current set value second voltage (object) 208  
 Current threshold for homing mode (object) 187  
 Custom persistent memory (object) 134  
 Custom persistent memory 1...4 (object) 134  
 Cycle time (object) 114, 118  
 Cycle time too small (object) 117, 120  
 Cyclic Synchronous Position Mode (brief description) 22  
 Cyclic Synchronous Torque Mode (brief description) 22  
 Cyclic Synchronous Velocity Mode (brief description) 22

**D**

Delay time (object) 116  
 Detected module ident list (object) 267  
 Device type (object) 70  
 Diagnosis History (object) 81  
 Diagnosis message 1...5 (object) 84  
 Digital Hall sensor (object) 168  
 Digital Hall sensor pattern (object) 169  
 Digital Hall sensor type (object) 168  
 digital Hall sensors (types) 168  
 Digital incremental encoder 1 (object) 156  
 Digital incremental encoder 1 index position (object) 157  
 Digital incremental encoder 1 number of pulses (object) 156  
 Digital incremental encoder 1 type (object) 157  
 Digital incremental encoder 2 (object) 170  
 Digital incremental encoder 2 index position (object) 171  
 Digital incremental encoder 2 number of pulses (object) 170  
 Digital incremental encoder 2 type (object) 171  
 Digital input 1...4 configuration (object) 195  
 digital input functionality 57  
 Digital input properties (object) 193  
 Digital inputs (object) 261  
 Digital inputs logic state (object) 193  
 Digital inputs polarity (object) 194  
 Digital output 1...2 configuration (object) 198  
 digital output functionality 59  
 Digital output properties (object) 197  
 Digital outputs (object) 262  
 Digital outputs logic state (object) 197  
 Digital outputs polarity (object) 197  
 dimensionless (units) 19  
 Disable operation option code (object) 224  
 Dual loop configuration miscellaneous (object) 186  
 Dual loop position control parameter set (object) 180



**E**

electric current (units) 19  
 Electrical inductance (object) 153  
 Electrical resistance (object) 153  
 Electrical system parameters (object) 153  
 Error behavior (object) 80  
 Error code (object) 220  
 Error history (object) 71  
 Error history 1...5 (object) 72  
 Error register (object) 70  
 errors  
   communication 292  
   device 273  
 EtherCAT communication error (internal) (error message) 285  
 EtherCAT communication cycle time error (error message) 285  
 EtherCAT communication error (error message) 284  
 EtherCAT error codes 293  
 EtherCAT initialization error (error message) 285  
 EtherCAT PDO communication error (error message) 286  
 EtherCAT Rx queue overflow (error message) 285  
 EtherCAT SDO communication error (error message) 287  
 EU directive, applicable 13  
 Extension 1 application number (object) 132  
 Extension 1 application version (object) 132  
 Extension 1 hardware version (object) 132  
 Extension 1 identity (object) 131  
 Extension 1 serial number (object) 133  
 Extension 1 software version (object) 131  
 Extension 1 type (object) 133  
 Extension 1 watchdog error (error message) 279

**F**

Fault reaction option code (object) 225  
 File incompatible (error code) 293  
 Firmware does not fit for hardware (error code) 293  
 Firmware incompatibility error (error message) 276  
 firmware versions 295  
 flags 66  
 Flags (object) 83  
 Flash problem (error code) 293  
 Flash status identification (object) 124  
 Following error (error message) 287  
 Following error actual value (object) 260  
 Following error time out (object) 228  
 Following error window (object) 227  
 Functional safety (object) 218

**G**

gateway communication 63  
 Gear configuration (object) 154  
 Gear miscellaneous configuration (object) 155  
 Gear reduction denominator (object) 154  
 Gear reduction numerator (object) 154  
 gear, virtual 139  
 General error (abort code) 292  
 General internal incompatibility error (abort code) 292  
 General parameter error (abort code) 292  
 Generic error (error message) 275  
 Generic initialization error (error message) 275

**H**

Hall angle detection error (error message) 282  
 Hall sensor (digital) 168  
 Hall sensor error (error message) 281  
 Hall sensor not found error (error message) 281  
 Hall sensors (types) 168  
 hardware binary files 295  
 Hardware defect error (error message) 278  
 Hardware error (abort code) 292  
 Hardware error (error message) 278  
 Hardware incompatibility error (error message) 278  
 hardware versions 78  
 High-speed digital input 1...4 configuration (object) 195  
 High-speed digital output 1 configuration (object) 198  
 High-speed digital output 2 configuration (object) 199  
 HMM (Homing Mode) 30  
 Holding brake fall time (object) 201  
 Holding brake maximal voltage (object) 202  
 Holding brake parameters (object) 200  
 Holding brake reduced voltage (object) 202  
 Holding brake rise time (object) 201  
 Holding brake state (object) 201  
 Home offset move distance (object) 187  
 Home position (object) 186  
 Homing 30  
 Homing acceleration (object) 240  
 Homing method (object) 238  
 Homing Mode (brief description) 22  
 Homing speeds (object) 239  
 how to  
   decode abbreviations and acronyms 10  
   determine output current limitation 54  
   interpret icons and signs used in the document 11  
   use Current Control Function 53  
   use Cyclic Synchronous Torque Mode 41, 47  
   use Cyclic Synchronous Velocity Mode 44  
   use Homing Mode 31  
   use Position Control Function 49  
   use Profile Position Mode 24  
   use Profile Velocity Mode 28  
   use Velocity Control Function 51

**I**

I2t level motor (object) 215  
 I2t level power stage (object) 215  
 Identity object (object) 77  
 Illegal (error code) 293  
 Illegal command error (abort code) 292  
 increments (units) 19  
 Index distance (object) 265  
 Inhibit time TxPDO 1 (object) 99  
 Inhibit time TxPDO 2 (object) 100  
 Inhibit time TxPDO 3 (object) 102  
 Inhibit time TxPDO 4 (object) 103  
 input functionality 57, 60  
 Internal software error (error message) 279  
 Interpolation time index (object) 248  
 Interpolation time period (object) 247  
 Interpolation time period value (object) 247

**L**

length (units) 19  
 Logic supply voltage too low error (error message) 278

**M**

Main loop filter coefficient a (object) 181  
 Main loop filter coefficient b (object) 181  
 Main loop filter coefficient c (object) 182  
 Main loop filter coefficient d (object) 182  
 Main loop filter coefficient e (object) 182  
 Main loop gain scheduling weight (object) 181  
 Main loop P gain high bandwidth (object) 180  
 Main loop P gain low bandwidth (object) 180  
 Main sensor direction error (error message) 283  
 Main sensor resolution (object) 148  
 Manufacturer device name (object) 73  
 mass (units) 19  
 Max acceleration (object) 248  
 Max gear input speed (object) 155  
 Max motor speed (object) 235  
 Max position limit (object) 234  
 Max position range limit (object) 233  
 Max profile velocity (object) 235  
 Max system speed (object) 149  
 Maximal temperature power stage (object) 216  
 Maximum messages (object) 81  
 Maximum number of modules (object) 265  
 Min position limit (object) 234  
 Min position range limit (object) 233  
 Minimum cycle time (object) 115, 119  
 Missing commutation sensor error (error message) 283  
 Missing main sensor error (error message) 282  
 Modes of operation (object) 226  
 Modes of operation display (object) 226  
 modes, supported 22  
 Modular device profile (object) 265

Module 1, configured (object) 266  
 Module 1, detected (object) 267  
 Motion profile type (object) 237  
 Motor control (object) 219  
 Motor data (object) 150  
 Motor rated torque (object) 231  
 motor speed 235  
 Motor type (object) 263  
 motor types, supported 13

**N**

Nbr of configured modules (object) 266  
 Nbr of detected modules (object) 267  
 Negative limit switch error (error message) 287  
 New messages available (object) 82  
 Newest acknowledged message (object) 82  
 Newest message (object) 81  
 No abort (abort code) 292  
 Node-ID (object) 126  
 Nominal current (object) 150  
 Not bootstrap (error code) 293  
 Number of assigned RxPDOs (object) 112  
 Number of assigned TxPDOs (object) 113  
 Number of errors (object) 71  
 Number of mapped objects in RxPDO 1 (object) 91  
 Number of mapped objects in RxPDO 2 (object) 93  
 Number of mapped objects in RxPDO 3 (object) 94  
 Number of mapped objects in RxPDO 4 (object) 96  
 Number of mapped objects in TxPDO 1 (object) 104  
 Number of mapped objects in TxPDO 2 (object) 106  
 Number of mapped objects in TxPDO 3 (object) 107  
 Number of mapped objects in TxPDO 4 (object) 109  
 Number of pole pairs (object) 152  
 Number of used SYNC manager channels (object) 110

**O**

object codes 65  
 Object does not exist error (abort code) 292  
 object lost (see "CAN overrun error")  
 object overview 66  
 operating license 13  
 Output current limit (object) 151  
 output functionality 59  
 Overcurrent error (error message) 276  
 overview (objects) 66  
 Overvoltage error (error message) 277

**P**

Password error (abort code) 292  
 PDO length error (abort code) 292  
 PDO mapping error (abort code) 292  
 Persistent parameter corrupt error (error message) 280  
 Physical outputs (object) 262  
 Position actual value (object) 227  
 Position actual value sensor 1 (object) 256  
 Position actual value sensor 2 (object) 257  
 Position actual value sensor 3 (object) 257  
 Position control parameter set (object) 173  
 Position controller D gain (object) 174  
 Position controller FF acceleration gain (object) 174  
 Position controller FF velocity gain (object) 174  
 Position controller I gain (object) 173  
 Position controller P gain (object) 173  
 Position demand value (object) 227  
 Position offset (object) 242  
 Position range limit (object) 233  
 Position sensor breach error (error message) 280  
 Position sensor error (error message) 280  
 Position sensor index error (error message) 281  
 Position sensor resolution error (error message) 280  
 Position window (object) 229  
 Position window time (object) 230  
 Positive limit switch error (error message) 287  
 Power limitation (object) 215  
 Power stage protection error (error message) 276  
 Power supply (object) 134  
 Power supply overvoltage limit (object) 137  
 Power supply supervision (object) 135  
 Power supply undervoltage limit (object) 135  
 Power supply voltage (object) 134  
 PPM (Profile Position Mode) 23  
 prerequisites prior installation 13  
 Producer heartbeat time (object) 77  
 Product code (object) 78  
 Profile acceleration (object) 236  
 Profile deceleration (object) 236  
 Profile Position Mode (brief description) 22  
 Profile velocity (object) 236  
 Profile Velocity Mode (brief description) 22  
 Program control (object) 122  
 Program data (object) 121  
 Program error (error code) 293  
 Program number 1 (object)  
     Flash status identification 124  
     Program control 122  
     Program data 121  
     Program software identification 123  
 Program software identification (object) 123  
 purpose of this document 9  
 PVM (Profile Velocity Mode) 27  
 PWM duty cycle actual value (object) 219

**Q**

Quick stop deceleration (object) 237  
 Quick stop option code (object) 223

**R**

Read only error (abort code) 292  
 Receive PDO 1 mapping (object) 91  
 Receive PDO 1 parameter (object) 86  
 Receive PDO 2 mapping (object) 93  
 Receive PDO 2 parameter (object) 88  
 Receive PDO 3 mapping (object) 94  
 Receive PDO 3 parameter (object) 89  
 Receive PDO 4 mapping (object) 96  
 Receive PDO 4 parameter (object) 90  
 reference point (see "Homing")  
 Restore all default parameters (object) 75  
 Restore default parameters (object) 75  
 Revision number (object) 79  
 revolutions (units) 19  
 RPDO timeout (error message) 286  
 RS232 bit rate (object) 128  
 RS232 frame timeout (object) 129  
 RS232-to-CAN gateway 64

**S**

Save all parameters (object) 74  
 SDO complete access not supported (abort code) 292  
 SDO server parameter (object) 85  
 SDO timeout (abort code) 292  
 sensor types 139  
 Sensors configuration (object) 138  
 Serial number (object) 79  
 Serial number complete (object) 131  
 Service parameter error (abort code) 292  
 Service parameter too short error (abort code) 292  
 Shutdown option code (object) 224  
 SI unit acceleration (object) 242  
 SI unit position (object) 240  
 SI unit position controller I gain (object) 175  
 SI unit velocity (object) 241  
 Sign of life error (error message) 279  
 signs used 11  
 SM-event missed (object) 116, 120  
 Software parameter error (error message) 279  
 Software position limit (object) 234  
 Software position limit error (error message) 287  
 Speed for switch search (object) 239  
 Speed for zero search (object) 239  
 SSI absolute encoder (object) 160  
 SSI commutation offset value (object) 165  
 SSI data rate (object) 160  
 SSI encoding type (object) 162  
 SSI number of data bits (object) 161  
 SSI position bits (object) 166

SSI position raw value (object) 164  
 SSI position raw value complete (object) 167  
 SSI power up time (object) 164  
 SSI refresh frequency (object) 164  
 SSI sensor error (error message) 282  
 SSI sensor frame error (error message) 282  
 SSI special bits leading data (object) 167  
 SSI special bits trailing data (object) 163  
 SSI timeout time (object) 163  
 Standstill window (object) 192  
 Standstill window configuration (object) 191  
 Standstill window time (object) 192  
 Standstill window timeout (object) 192  
 Statusword (object) 222  
 steps (units) 19  
 STO error (error message) 288  
 STO input states (object) 218  
 Store parameters (object) 74  
 Subindex cannot be written (abort code) 292  
 Subindex error (abort code) 292  
 Supported drive modes (object) 264  
 Supported homing methods (object) 251  
 supported modes 22  
 symbols used 11  
 Sync error (object) 117, 121  
 SYNC manager 2 parameter (object) 114  
 SYNC manager 2 PDO assignment (object) 112  
 SYNC manager 3 parameter (object) 118  
 SYNC manager 3 PDO assignment (object) 113  
 SYNC manager communication type (object) 110  
 Synchronization type (object) 114, 118  
 Synchronization types supported, input (object) 119  
 Synchronization types supported, output (object) 115  
 System overloaded error (error message) 288  
 System peak overloaded error (error message) 288

## T

Target position (object) 232  
 Target torque (object) 231  
 Target velocity (object) 263  
 Temperature power stage (object) 216  
 Thermal motor overload error (error message) 277  
 Thermal overload error (error message) 277  
 Thermal overload protection (object) 216  
 Thermal time constant winding (object) 152  
 time (units) 19  
 Toggle error (abort code) 292  
 Torque actual value (object) 231  
 Torque actual value averaged (object) 189  
 Torque actual values (object) 189  
 Torque constant (object) 152  
 Torque offset (object) 243  
 Touch probe 1 negative edge (object) 246  
 Touch probe 1 negative edge counter (object) 250  
 Touch probe 1 positive edge (object) 245  
 Touch probe 1 positive edge counter (object) 250  
 Touch probe 1 source (object) 249  
 Touch probe function (object) 244  
 Touch probe source (object) 249  
 Touch probe status (object) 245  
 trajectory generator  
   Homing 30  
   Profile Position 24  
   Profile Velocity 27  
 Transfer or store error (abort code) 292  
 Transmission type RxPDO 1 (object) 87  
 Transmission type RxPDO 2 (object) 88  
 Transmission type RxPDO 3 (object) 89  
 Transmission type RxPDO 4 (object) 90  
 Transmission type TxPDO 1 (object) 98  
 Transmission type TxPDO 2 (object) 100  
 Transmission type TxPDO 3 (object) 101  
 Transmission type TxPDO 4 (object) 103  
 Transmit PDO 1 mapping (object) 104  
 Transmit PDO 1 parameter (object) 97  
 Transmit PDO 2 mapping (object) 106  
 Transmit PDO 2 parameter (object) 99  
 Transmit PDO 3 mapping (object) 107  
 Transmit PDO 3 parameter (object) 101  
 Transmit PDO 4 mapping (object) 109  
 Transmit PDO 4 parameter (object) 102

## U

Undervoltage error (error message) 277  
 units (definition of) 19  
 USB frame timeout (object) 129  
 USB-to-CAN gateway 64

**V**

Value range error (abort code) 292  
velocity (units) 19  
Velocity actual value (object) 230  
Velocity actual value averaged (object) 190  
Velocity actual value averaged sensor 1 (object) 259  
Velocity actual value averaged sensor 2 (object) 259  
Velocity actual value averaged sensor 3 (object) 259  
Velocity actual value sensor 1 (object) 258  
Velocity actual value sensor 2 (object) 258  
Velocity actual value sensor 3 (object) 259  
Velocity actual values (object) 190  
Velocity control parameter set (object) 176  
Velocity controller FF acceleration gain (object) 177  
Velocity controller FF velocity gain (object) 177  
Velocity controller filter cut-off frequency (object) 177  
Velocity controller I gain (object) 176  
Velocity controller P gain (object) 176  
Velocity demand value (object) 230  
Velocity observer friction (object) 179  
Velocity observer inertia (object) 179  
Velocity observer load correction gain (object) 179  
Velocity observer parameter set (object) 178  
Velocity observer position correction gain (object) 178  
Velocity observer velocity correction gain (object) 178  
Velocity offset (object) 243  
Velocity set value first velocity (object) 211  
Velocity set value first voltage (object) 211  
Velocity set value second velocity (object) 212  
Velocity set value second voltage (object) 211  
Vendor ID (object) 77  
version history 295  
virtual gear 139

**W**

Watchdog error (error message) 288  
Write only error (abort code) 292  
Wrong device state error (abort code) 292  
Wrong NMT state error (abort code) 292

**Z**

zero point (see “Homing”)



EtherCAT® is a registered trademark and patented technology, licensed by Beckhoff Automation GmbH, Germany

This document is protected by copyright. Any further use (including reproduction, translation, microfilming, and other means of electronic data processing) without prior written approval is not permitted. The mentioned trademarks belong to their respective owners and are protected under intellectual property rights.

© 2022 maxon. All rights reserved. Subject to change without prior notice.

CCMC | EPOS4 Firmware Specification | Edition 2022-04 | DocID rel10503

maxon motor ag  
Brünigstrasse 220  
CH-6072 Sachseln

+41 41 666 15 00  
[www.maxongroup.com](http://www.maxongroup.com)